

BATTLEFLEET GOTHIC 2010

FREQUENTLY ASKED QUESTIONS, ERRATA AND RULE ADDITIONS

The intent of this FAQ/Errata along with the rest of the 2010 Compendium is to finally tie up some loose ends that needed fixing for quite some time. The Compendium also incorporates many of the rule sets introduced in the Battlefleet Gothic Magazine, 2002 Annual and Fanatic Magazine. This document is intended for use with the most recent online versions of the Battlefleet Gothic Rulebook and Armada and the files at Games Workshop's Specialist Games Battlefleet Gothic Resources website as of December, 31st, 2010. It is also heavily cross-referenced; any references listed in italics refer to pages in this same document. For all intents and purposes this supersedes any previously released FAQ and Errata. Note that the online rules correct a number of deficiencies in the printed rulebook, not all of which are reiterated here.

Please note that besides additions and changes, the intention of this document is to address unusual circumstances and situations that do not normally come up in gameplay, and so by intent some of the topics are discussed in far greater detail than would normally be covered in the standard rules. However, it is almost guaranteed that in the course of gameplay, some situation is going to come up that is not covered by this FAQ. Additionally, keep in mind that this does not preclude two players adjusting or "breaking" the rules as they see fit as long as both players agree. In all cases, Johnson's Razor applies: if there is more than one way to interpret an unusual situation, always go for that fairest to both players. As this is a GAME and therefore played for FUN, there is no reason why these cannot be resolved simply by looking at which solution is the fairest for all players should the situation be reversed. Should this not work, make a coin toss or D6 roll to decide the outcome, game on and enjoy!

TABLE OF CONTENTS

| |
|---|
| Set-Up- 2 |
| Orders/Leadership- 2 |
| Movement- 3 |
| Shooting -4 |
| Blast Markers- 4 |
| Nova Cannon- 5 |
| Area Effects and Special Weapons- 6 |
| Ordnance- 6 |
| Torpedoes- 7 |
| Attack Craft- 8 |
| Resilient Attack Craft- 8 |
| Combat Air Patrol- 9 |
| Orbital Mines- 10 |
| Massing Turrets / Turret Suppression- 10 |
| Ramming, Boarding and Base Size- 11 |
| Hit and Run Attacks / Critical Damage- 12 |
| Catastrophic Damage- 13 |
| Squadrons- 13 |
| Disengaging- 14 |
| Celestial Phenomena- 15 |
| Planetary Defenses- 16 |
| Transports- 16 |

| |
|--|
| General Fleet Restrictions and Options- 16 |
| Reserve Fleets and Reinforcements- 17 |
| Allies, Subjects and Mercenaries- 18 |
| Imperial Navy, Space Marines and Adeptus Mechanicus fleets- 19 |
| Chaos fleets- 22 |
| Eldar, Craftworld Eldar and Dark Eldar fleets- 24 |
| Ork fleets- 26 |
| Necron fleets- 28 |
| Tyranid fleets- 29 |
| Tau and Demiurg fleets- 31 |

BATTLE FLEET BAKKA

Page 32

ORDERS OF THE INQUISITION

Page 45

SPACE MARINE DOMINIONS

Page 53

ADEPTUS MECHANICUS

Page 62

ROGUE TRADERS

Page 70

POWERS OF CHAOS

Page 101

CRAFTWORLD ELДАР

Page 124

ORK CLANZ

Page 146

TAU KOR'OR'VESH

Page 155

BATTLEFLEET GOTHIC

Andy Chambers, Gavin Thorpe, Jervis Johnson, Matt Keefe, and Andy Hall

THE 2010 COMPENDIUM

Battlefleet Gothic Rules Review Committee
Bob Henderson, Ray Bell and Nate Montes

Special Thanks to

Roy Amkreutz, Fred Martinson, Robert C. M. Passovoy, Aaron Dickey, Wesley Herndon, Colin Young, Dex Sy, Brandon Pooley Sam Stewart, John Lamshead and Matt Sprange

Graphic design and layout by Nate Montes

All illustrations and intellectual property
©1999-2011 Games Workshop

SET-UP

Definition of Game Turns: A game turn is both player turns, so a game that lasts eight turns has sixteen player turns.

Pre-measurement: You may pre-measure movement and range unless all players agree not to. Note: To aid in pre-measuring, use a couple of empty flying bases with bearing compasses dropped over the stems.

Secrecy of Fleet Lists: Fleet lists are not normally secret. However, to add a degree of subtlety to a campaign, fleet lists may be kept secret until the end of the game (or campaign) if both players agree. However, it must be written down, complete with all refits and point totals. If at any time your opponent wishes to see your fleet list, both players must then immediately reveal their fleet lists to each other.

Secrecy of Subplots: Subplots are normally rolled for in front of both players at the beginning of the game. However, subplots may be kept secret in the same manner as described previously for fleet lists if both players agree. However, they must be written down at the beginning of the game, and if at any time your opponent wishes to see your subplot(s), both players must then immediately reveal them to each other. If kept secret, they must nonetheless be revealed at the end of the game.

ORDERS/LEADERSHIP

Special orders are declared during the movement phase by choosing a vessel or squadron, declaring the order and rolling leadership, then moving it. This is repeated until a vessel fails its command check, after which any remaining ships finish moving normally.

A ship or defense can never be on more than one special order at a time unless described otherwise in its special rules, such as a Ramilies Star Fort.

Under no circumstance can a ship's leadership be modified higher than Ld10, though various combinations of effects all affect the ship or squadron normally. For instance, an Admiral with Leadership 10 aboard a ship in contact with Blast Markers (-1Ld) while the enemy is on special orders (+1Ld) is Ld10.

In effect, a leadership check roll of 11 or 12 always fails unless SPECIFICALLY stated otherwise.

If a ship through a combination of effects is reduced to Ld1 or less, it cannot make any special orders or leadership tests of any kind unless some combination of modifiers brings the leadership test it is attempting to make at least 2 or more, such as attempting to disengage near celestial phenomena, etc.

When rolling special orders, a decision to use free command checks (such as with an Elite Command Crew or when Orks use All Ahead Full special orders) must be taken before a special order is failed. Once special orders are failed, no more special orders can be declared except Brace For Impact.

Only one re-roll can be spent on a vessel or squadron per leadership check. In other words, if a vessel or squadron fails a leadership check and then fails a re-roll, another re-roll cannot be expended on it for the same leadership check or special order on that vessel, even if more re-rolls are available.

A capital ship squadron always rolls special orders or leadership tests together, benefiting from the leadership of the highest leadership of any surviving vessels in the squadron, even if crippled (this differs only if an individual capital ship wishes to disengage). They also take advantage of any leadership bonuses of any vessel in the squadron, as long as it does not exceed that of the highest leadership in the squadron. For example, if a capital ship squadron has a ship that is Ld8 and a ship that is Ld6 but gets an additional +1Ld when the enemy is on special orders (to Ld8), the squadron cannot combine these effects, meaning its leadership will only be Ld9 if the enemy is on special orders. Conversely, the squadron suffers leadership modifiers if any one vessel in the squadron is in contact with blast markers, regardless of whether or not it is the vessel with the highest leadership. *See p.13 for more about capital ship squadrons as well as how individual capital ships may disengage.*

A ship with an embarked Admiral, Warmaster, etc. has its leadership superseded by that of the embarked fleet commander. This includes circumstances where

the Fleet Commander has a lower leadership than the ship he is embarked on!

Just like ship's captains and crews, Chaos Lords, Ork Warlords, etc. can gain experience (leadership) in a campaign. Note that improvements can only be based on the ship's or commander's natural leadership, not on any bonuses gained by the ship itself. For example, an Emperor battleship with a natural Ld7 is effectively Ld8 in battle because of its inherent +1Ld bonus, but it can only gain crew skills once its natural Leadership is at least Ld8. Crew skills can only be gained by ships, not Fleet Commanders

If a ship containing a fleet commander, Warlord, Mark of Chaos, etc. is destroyed, the cost of any embarked commanders or other improvements are included in the Victory Points earned by the enemy, even if it can be assumed the fleet commander escaped to fight another day. For example, if an Ork Kill Kroozer (155 pts) with an embarked Warlord and Mad Meks (+65 pts) is destroyed, the opponent earns a total of 220 pts, and obviously the Warlord and his Meks are lost for the game. However, in a campaign, the Warlord manages to get his hands on another Kill Kroozer (or whatever) and gather around him some Meks. Or, if you like, another Warlord showed up to take his place with his own mob of Mad Meks!

If a Fleet Commander with particular bonuses (such as Chaos Marks or Ork benefits) moves to another ship that already has particular crew skills, they may be combined as long as they do not contradict each other. For example, a Chaos fleet commander with a Mark of Slannesh using the 13th Black Crusade fleet list cannot use as a flagship a vessel with the Mark of



Khorne. Crew skills also cannot be multiplied; an Ork Warboss Fleet Commander with Mad Meks that moves to another ship that ship already had Mad Meks gains no additional benefit from this.

Any ship described as being on standby may not move, fire weapons or launch ordnance. It may however attempt to Brace and repair critical damage. Turrets and shields work normally. While on standby, ships obviously count as defenses against the gunnery table, with all modifiers applied normally. Ships on standby must follow the rules in the particular scenario to come out of standby, after which they behave normally in all respects.

ALL AHEAD FULL: Ships in a squadron all go the same +nD6cm distance when on All Ahead Full special orders unless they use less dice, are slowed down by celestial phenomena, being crippled, etc.

If a squadron with multiple D6 values when All Ahead Full take this special order, the ship(s) that takes less D6 uses the highest rolled dice in its move.

RELOAD ORDNANCE: Any reference or mention in the rules concerning running out on doubles when rolling to Reload Ordnance no longer applies and may be ignored.

Reload Ordnance and Movement: Movement is unaffected by the reload ordnance special order.

BRACE FOR IMPACT: Brace For Impact special orders can be undertaken ANY time a ship faces taking damage before the actual to-hit result is rolled, including when ramming or being rammed or against damage from asteroid fields. For example, you do not have to make the leadership check to brace until you know a ship has successfully passed its test to ram, but it must be made before any damage rolls are made. In the same manner, one does not have to brace for damage against traversing asteroid fields until after one actually fails the leadership test to traverse the field but before any rolls to inflict damage are made. When facing damage from an exploding vessel, one may wait until the 3D6cm measurement for blast radius is made but before any hits are rolled. It may now also be used to protect against critical damage from any kind of H&R attack.

See p.10 for more on ramming, p.12 for more on catastrophic damage and p.14 for more on how ships take damage from asteroid fields.

In all cases Brace For Impact REPLACES whatever special order the ship or squadron may currently be on. However, the special order previously in effect remains so, in that ships that reloaded ordnance are still reloaded, a ship or squadron moving All Ahead Full must continue to do so, etc.

Brace For Impact DOES NOT protect against critical damage caused by hits that were not saved against normally, nor any damage caused during a boarding action (including critical damage). Being braced protects against actual damage taken by the ship itself, NOT hits absorbed by shields, reactive armor, holofields, etc.

A decision to brace for impact must be made before any attempt to shoot (rolling dice) by the opponent is made, including modifier rolls for variable weapons such as Ork Gunz. When being attacked by ordnance, the decision must be made before rolling turrets.

Brace For Impact does NOT halve turret values. However, it is the only special order that halves a ship's ability to launch ordnance, provided the launching vessel is already reloaded. This effect is cumulative if a capital ship is crippled, *see p.4*.

A ship that fails an attempt to Brace For Impact cannot attempt again to Brace until the ship, squadron, ordnance wave or other event causing damage to it completes its attacks, finishes causing damage, resolves its effects, etc. It can however again attempt to brace before the next ship, squadron or ordnance wave attacks it, it faces another potentially damaging event, etc.

When a ship's or squadron's weapons are halved for whatever reason (such as being Braced), total up the combined strengths (rounding up) before halving or splitting firepower. For escorts in particular, total all combined strengths for the entire squadron before halving or splitting firepower. For example, if a squadron of five or six Eldar Hemlocks are braced, they have a total of three pulsar lances. *See p.13 for more about squadrons affected by being Braced.*

Brace For Impact Against Multiple Damage Weapons: When making brace saves against multiple damage weapons, such as Ork Heavy Gunz or Dark Eldar Phantom Lances, total the damage caused and then save for each point of damage caused past shields as normal. Example: Heavy Gunz hit a braced squadron of Swords 5 times, total the damage to 10 then make a save roll per hit past shields.

COME TO NEW HEADING: This special order does not allow capital ships to double their turn rate all at once; they may instead turn twice in a single movement phase instead of once, each time turning no more than they would normally. Capital ships under this special order must move their minimum distance before turning for BOTH their turns. For example, an Imperial cruiser must move 10cm, turn, then move an additional 10cm before turning again. If it cannot because of movement modifiers, then it cannot take advantage of this Special Order. *See p.14 about how gravity wells can affect this.*

All Ahead Full, Come to New Heading and Burn Retros halves firepower and lance strength but not torpedo or attack craft launch capability.

MOVEMENT

A ship can only count forward movement made during a given movement phase before turning. In other words, a cruiser that moves straight ahead at least 10cm without turning in a movement phase cannot count that movement to immediately turn in the next movement phase. This does not apply to Space Hulks or other vessels specifically addressed as utilizing special turning rules.

Flying Bases Overlapping: As ships can overlap by flying over/under one another it is possible to stack ships. When ships overlap it is common practice to remove the models from their flying bases. To keep things clear, it is usually best to have a few stemless flying bases around with a straight line draw from the central hole to the bases edge to indicate direction. If desired, numbered contact markers can be used for this as well. The drastic weakening of their shield strength usually discourages this as described in the section on blast markers, but it is completely legal.

Stacking Ships and Escort Squadrons: Cruisers and escorts can be stacked to follow the movement of battleships and other models that use a large base. If the models do not physically fit where they should be located, a contact marker or similar can be used for this purpose. As a rule, ships should only be stacked or overlap as an unavoidable consequence of movement or to attain a particular shooting solution and should not be used solely because it is allowed.

When a ship is forced to stand still, it counts as being targeted as Defenses. People have taken this to mean, "If I stand still in high orbit I count as defenses, but if I move 0.5cm, I don't." Minimum move distance to not count as defenses is at least 5cm.

At no time do ships count as moving simultaneously (even if in a squadron) and must always be moved one at a time, in any order desired by the owning player.

SHOOTING

Escort squadrons have their total firepower halved as described on p.2 when on special orders that affect weapons strength/firepower. Capital ships have their firepower/strength halved individually, even if in a squadron. Escort squadrons do not have their weapon strength halved solely because the squadron is



crippled (reduced to half its starting number). *See p.13 for more about escort squadrons.*

When shooting and the line of fire is on the line in-between arcs, the shooting player chooses which arcs to use, whether it is the attacking or defending ship.

USING THE GUNNERY TABLE: If a ship or squadron has multiple weapon types that rely on the gunnery table, such as Bombardment Cannons, Heavy Gunz or standard Weapons Batteries, they may be fired simultaneously. Calculate the dice on the gunnery table separately for each type of gunnery weapon. This means you do not suffer gunnery shifts due to blast markers caused by other members of the same squadron in the same shooting phase. The order in which these weapons hit is up to the shooting player, so Bombardment Cannons can hit after weapons batteries have taken down shields for instance, or vice versa if desired.

Any battery weapon that always counts targets as closing on the gunnery table still uses the far left column when targeting defenses, applying any modifiers as applicable.

No target aspect or modifier adjusts shooting beyond the far left or right columns on the gunnery table.

If a combination of ships in a squadron has a firepower value greater than 20, look up 20 and the remaining firepower values separately and add them together. For example, a squadron of two Carnages can have up to firepower 32 in one broadside, or firepower (20+12).

SPLITTING FIRE: You cannot split weapons battery or lance fire of any type at a single target! Splitting fire is still allowed normally when firing at multiple targets, as described on p.21 of the rulebook.

Ships with multiple weapons in a given fire arc may split their weapon strength between two or more targets but must still make a leadership check to fire on any target besides the closest. *See p.12 for how this applies to hulked vessels.*

A ship electing to fire at ordnance does not have to make a leadership check to ignore closer ship targets, nor does it have to make a leadership check to ignore enemy ordnance if it is the closest target. It must still

make a leadership check to split its fire between ordnance targets, just as it would have to split fire normally. It also must make a leadership check to fire on an enemy ordnance marker, wave or salvo if it is not the closest enemy ordnance marker in range. *See p.5 for more on ordnance.*

BLAST MARKERS AND DAMAGE

A ship in base contact with a blast marker means the whole base is affected. It counts as being in contact all around it and in every arc for purposes of leadership, movement, shooting, ordnance attacks, being boarded, or every other respect where blast markers have an effect. This includes if it ended its movement in contact with a blast marker for any reason. A vessel is considered to be moving through blast markers even if it is moving away from blast markers it is in contact with at the beginning of the movement phase, such as blast markers in its rear arc or in base contact due to a previous round of shooting.

If a ship moves into base contact with another ship that already has a blast marker but the blast maker does not touch its own base, it does not count as having a blast marker in contact as well. In other words, a ship in contact with a blast marker does not in and of itself count as being a blast marker for purposes of being in base contact with other ships.

Ships firing weapons that rely on the gunnery table suffer a right column shift if they or their targets are in base contact with blast markers or if the line of fire crosses any blast markers. Ordnance attacking ships with blast markers in base contact must first roll a D6, removing the entire wave or salvo on a roll of 6.

When shooting at ships, the first blast marker is placed directly in the line of fire from the shooting vessel, with subsequent blast markers fanning out around it. Blast markers cannot be stacked unless there is physically no more room to place blast markers around a target's base. *See p.12 for how catastrophic damage can affect this.*

When a ship has multiple bases in contact when taking fire, the blast marker is placed between the base of the ship taking fire and the ship closest in the

line of fire to the ship taking fire. In other words, a single round of shooting from a ship or squadron cannot place blast markers in base contact with more than one other vessel besides the vessel it is shooting at (for two in total) except in the following cases:

1. A ship with multiple shields (like a battleship) takes three or four blast markers that when fanned out normally contact more than one vessel in actual base contact (as opposed to “close to but not actually touching”). In other words, if a ship in base contact with the ship under fire comes in contact with blast markers being normally fanned around the base of the ship taking fire, then it comes in contact with a blast marker as well. When merely in base contact with the ship fired upon, the blast marker must physically touch the bases of the ships it is affecting in this manner.
2. Any and all ships with bases that are actually stacked or are in any way overlap on the base of a ship in contact with blast markers, which is different from mere base contact and is explained separately.

When ships have stacked or overlapping bases, there is no limitation to the number of ship’s shields a blast marker can take down if one of them is in contact with blast markers. A ship overlapping a ship in contact with a blast marker also counts as being in contact with it. However, in situations where multiple ships are overlapping each other, this does not cascade to other vessels. For example, Ship #2 overlaps on Ship #1, which has a blast marker in contact with it. Ship #3 overlaps on Ship #2 but not on Ship #1. Ship #2 counts as having a blast marker on it, but as long as the blast marker does not physically touch Ship #3, it does not count as being in contact with a blast marker.

Blast markers placed in base contact with a ship that took fire do not affect ships near to but not actually in base contact with that ship. Place blast markers so they do not touch the bases of ships nearby but not actually in base contact. This is not a “counts as” rule; one cannot declare a ship is actually not in base contact if it is making physical contact.

A ship only risks damage from moving through blast markers if it has suffered a Shields Collapse critical hit or if the vessel does not have shields, such as Eldar. Ships with shields overloaded by taking fire but are otherwise functional do not risk taking damage on a D6 roll of 6.

Movement through blast markers reduces speed by a total of 5cm, regardless of how many are moved through in each movement phase. This affects each separate movement phase for Eldar vessels. Ships that do not have shields, such as Eldar or vessels with a Shields Collapsed critical, only need to test once against a D6 for damage regardless of how many blast markers they encounter in their movement. Eldar however have to do this one time for each of their two movements per turn if they encounter blast markers in both their movements.

If a ship cannot elect to slow down (such as when on All Ahead Full special orders) and comes into contact with a blast marker within the last 5cm of its movement, it must instead stop no farther than the point it comes in contact with the blast marker (and not before).

DESTROYED ESCORTS: When an escort is destroyed replace it with a blast marker placed as centrally as possible to where the escort was. As a blast marker is smaller than a small flying base, the only way it is possible to take down a ship’s shield with this blast marker is if their bases actually overlapped.

CRIPPLED CAPITAL SHIPS: Being crippled halves shields, turrets, ordnance, all weapons and affects boarding. This effect is cumulative if the ship is braced, meaning if a ship is both braced and crippled, its weapons and ordnance are halved (rounding up) again! For example, a Styx heavy cruiser that is both braced and crippled has a total launch bay strength of 2, or $6/2 = 3$, then $3/2 = 1.5$ (rounding up) = 2. If it suits you, assume it is a quarter, rounding up.

NOVA CANNON

Nova Cannon are no longer a guess-range weapon, and it can be fired per-ship normally as opposed to all

at once in the beginning of the shooting phase. When firing, the template is placed anywhere desired so that its edge is between 30-150cm from the firing vessel. It does not have to be centered on a single ship and can be placed in contact with multiple targets. If placed within 45cm of the firing ship, roll a scatter die and 1D6. Roll 2D6 if the template is between 45 to 60cm of the firing ship, or 3D6 if it is placed beyond 60cm. Move the template a number of cm rolled by the dice in the direction of the scatter die roll. If the scatter die rolls a “hit,” the template remains where placed. Any target that is in base contact of the template after it is moved takes one hit. Any target in base contact of the center hole of the template takes D6 hits. Replace the template with a single blast marker if it does not contact a target after being moved.

The correct dimensions of the Nova Cannon template are a 5cm outer diameter with the hole’s diameter at 1.2cm. The Nova Cannon template’s dimensions can be found on Games-Workshop’s small green blast template where the perimeter is marked with a 2, this does not include the width of the line. Use the larger hole in the center of the template if there are two sizes.

The Nova Cannon is a line of sight weapon and cannot fire through obstacles or celestial phenomena that act as normal line of sight obstructions, such as planets, moons, asteroid fields, etc. If desired however, these can nonetheless be fired upon. If a direct hit is scored on the scatter dice, place D6 blast markers in contact with the planet or asteroid field edge.

Nova Cannon are unaffected in any way by Lock-On or Reload Ordnance special orders.

After the attacking player designates which target is being fired on, the defending player must decide whether or not to brace ships or squadrons BEFORE the weapon is fired. This includes targets the weapon may hit due to miss distance or scatter.

HOLOFIELDS: Holo-fields and similar systems save against the shell hit, not the subsequent damage rolls. For example, if an Eldar vessel is hit by a Nova Cannon round and fails to save, it must immediately

take as many hits as the damage roll allocates unless it successfully braced beforehand.

Holofield saves are taken against a direct hit from a Nova Cannon where the hole is over the base as well as against the single automatic hit for coming in base contact with the blast template. If this save is successful the effect of the Nova Cannon is negated, and a blast marker is placed normally for the save. Being braced saves against any damage taken normally. *See p.23 for more on holofields.*

AREA EFFECTS AND SPECIAL WEAPONS

Some weapon systems such as the Necron Nightmare Field and Star Pulse Generator are area-effect weapons that do not aim nor are directed at a particular target. Such weapons or effects are not blocked by line of sight obstructions such as hulks, minefields or celestial phenomena, nor can they be saved against by holofields. *See p.12 for more on catastrophic damage and exploding ships.*

Chaos Marks that affect nearby ships based on area as well as catastrophic events such as Warp Drive implosions, Solar Flares, etc. are also not affected by celestial phenomena and other such line-of-sight obstructions. *See p.14 concerning asteroid fields.*

Exterminatus vessels used in scenarios that require them normally replace their standard prow weapon with an Exterminatus one. Vessels that do not normally have prow weapons (such as Vengeance grand cruisers) cannot be used as Exterminatus vessels.

Armageddon Gun and Holofields: Holofield saves are taken against a direct hit from the Armageddon Gun

where the hole is over the base as well as against the single automatic hit for coming in base contact with the blast template. If this save is successful the effect of the Armageddon Gun is negated, and a blast marker is placed normally for the save. Being braced saves against any damage taken normally.

ORDNANCE

Ordnance no longer runs out when rolling a double when attempting Reload Ordnance special orders. Any reference to running out of ordnance can be ignored. When launching attack craft, no more attack craft markers can be put in play than the number of available launch bays, even if it has successfully reloaded. Any model or fleet described as not able to run out of ordnance (such as Ork Space Hulks, the Tyranid fleet, etc.) may launch up to twice this number and provide double their number of launch bays to the total amount of markers the fleet may have in play. This total limit applies to the fleet as a whole and not to individual ships in the fleet. Any individual carrier may launch attack craft if they have successfully re-loaded (even a partial amount) as long as the total amount of attack craft in play does not exceed the number of available launch bays. This total must take into account reductions caused by ships being crippled or lost in battle.

Ordnance is declared, placed on the table and launched at the end of the shooting phase as opposed to the beginning of the ordnance phase. If more attack craft remain in play than there are available launch bays, the owning player may not launch any ordnance that turn. However, ordnance in play may be “recalled” by immediately removing it from play in order to launch new markers from the ship’s stem, if it has successfully reloaded ordnance. Attack craft

recalled in this manner must be removed immediately and not expended on other targets, including enemy ordnance. This prevents a carrier from attacking a target to expend its attack craft in play and then launching a new attack craft wave in a single turn. This rule does not apply to torpedoes, which do not run out and do not have launch limits.

Launching ordnance of any amount expends ordnance for that turn and must be reloaded to launch again. For example, a carrier with four launch bays that due to ordnance limits cannot launch more than two attack craft cannot “save” the other two markers and must reload ordnance again before it can launch more attack craft. This same concept applies to torpedoes, though there are no launch limits for torpedoes. Launching only torpedoes does not affect launching attack craft later, and vice versa.

If a ship equipped with both torpedoes and attack craft launches only one or the other, it may still launch the other before having to reload again. For example, if an Imperial Dictator launches its attack craft but not its torpedoes in a turn and in the subsequent turn fails to Reload Ordnance, it may still launch its torpedoes in that turn.

Any ship that has either never launched ordnance or has successfully reloaded ordnance is considered to have its ordnance reloaded for as many turns as it does not launch, regardless of what subsequent special orders it takes. Keep in mind that being crippled and/or braced still affect torpedo launchers and attack craft bays normally.

Ordnance waves or salvos that are hit by direct-fire weapons (such as gunnery or lances) on a roll of 6 remove the entire wave or salvo, NOT just a single torpedo or attack craft marker in the wave/salvo. *See p.4 for more on shooting at ordnance.*

Ordnance waves or salvos forced to move through multiple blast markers in one ordnance phase are only required to test one time against being removed on a D6 roll of 6. Any ordnance markers that either are or come in base contact with a ship with blast markers in contact must roll as if travelling through blast markers.

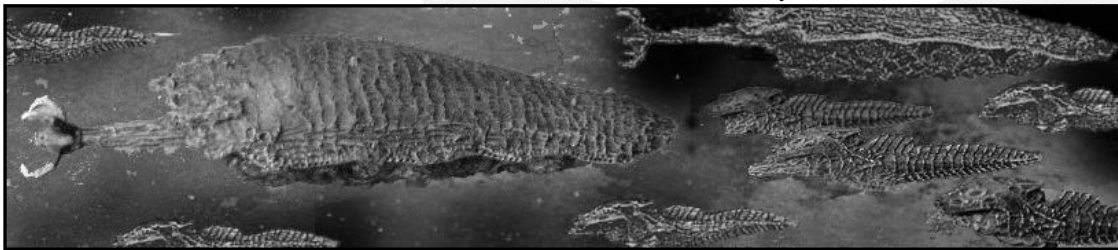

Ordnance attacks are always resolved immediately, including in the movement phase when a ship moves into enemy ordnance. This also allows small torpedo salvos from escorts to be used to clear the way of enemy fighters in the ordnance phase so that larger salvos can get through, etc. This now includes hit and run attacks caused by ordnance (instead of in the End Phase), such as by assault boats and boarding torpedoes.

Ordnance markers must always attack the first ordnance or vessels they come in contact with (when applicable). For example, a fighter squadron marker may not ignore a small torpedo salvo it is actually in contact with to attack a larger one nearby, or an attack craft wave may not ignore an escort it is in contact with to attack a nearby cruiser.

If two ships with the same base size are so aligned that they for all intents and purposes are occupying the same 2D position on the table when they are attacked by ordnance, the attacking player can pick which ship he or she is attacking. Put simply, if there is no way to visually identify which of two stacked or overlapping ships is actually closer to attacking ordnance, the attacker decides which target is being attacked.

TORPEDOES

A torpedo salvo (regardless of strength) is now represented with a Strength 3 marker with one or more D6 indicating the actual salvo strength. For specific dimensions, this marker should be no more than 2.5cm wide. Place the torpedo marker at the end of its movement in the turn of launch so that it is completely within the correct fire arc. Now retrace the markers movement, reducing its strength and conducting ordnance interactions as appropriate to prevent targeting vessels out of fire arc due to proximity, etc. *See p.14 for more on launching torpedoes while on a planetary template.*

Splitting Torpedo Salvos: Single ships capable of launching six or less torpedoes cannot split torpedo salvos at all. Single ships capable of launching salvos larger than six may split their salvos in two, representing them with two separate strength-3

markers. If this option is taken, the salvos must go in different directions (no double-attacks on the same target or in the same direction), and no single salvo can contain less than three torpedoes. Squadrons of capital ships or escorts are not obligated to fire their torpedoes in a single salvo.

No torpedo marker can attack a target more than once per full turn, even if they are already in contact with it at the start of the movement or ordnance phase. For example, a torpedo marker is launched toward a battleship with a large base, ending its movement just inside base contact with the battleship. The attack is resolved immediately, with turrets rolled and hits allocated. While any surviving markers remain in



play, they do not once again attack the same ship at the beginning of that ship's movement phase, and that ship is allowed to assume the torpedoes have flown off behind it and move off the torpedo marker. The marker will however immediately attack any other ship that comes in contact with it, even if the other ship is moved before the ship that was attacked originally.

When launching torpedoes, the torpedo marker will technically be in all arcs and may be in multiple arcs until its final position this movement, especially when targeting ships in close proximity. However, it may not interact with anything out of the torpedoes'

actual firing arc, no matter how close the target vessel is to the shooting vessel.

When moving a torpedo salvo the center must always be in the same point along the line of fire.

Massed Torpedo Salvos: When launching a combined salvo from a squadron the salvo must be in ALL of the ships appropriate firing arcs and its furthest edge at the limit of its speed from the furthest ship's stem. All the ships firing a combined salvo must be in base to base contact. Note that some ships (such as Ork Ravagers) cannot for any reason combine salvos in this manner.

When launched, torpedoes do not normally ignore any targets in front of them, including friendly units! However, a ship that is actually in base contact with another friendly vessel may "shoot through" the friendly ship's base, even if they are not in a squadron. Ships not in a squadron cannot use this effect to combine torpedo salvos in any way and must always launch torpedoes separately.

Torpedoes that have an automatic re-roll to hit MUST use their re-roll to hit a target, even if that target was already destroyed by other hits generated in the same salvo.

Turning Torpedoes: When turning torpedoes (that are allowed to do so), turn from the center of the marker at the beginning of the ordnance phase. Under no circumstances can torpedoes turn in the same ordnance phase they were launched. This means they can only be launched in the same arc normal torpedoes would be. If a salvo turns, it must be turned so that no edge moves more than the salvo's maximum speed in any way. This also means the side facing the inside edge of the turn may end up moving less than the maximum allowed distance.

Torpedoes do not normally ignore hulks in their line of movement. Boarding torpedoes may do so if desired, and guided torpedoes may be steered away from them but will still attack if they make contact. *Also see the torpedo bombers section on this page.*

BOARDING TORPEDOES: Boarding torpedoes hit against armor just like normal torpedoes, though they do not cause hits normally. Only those that hit

against armor may subsequently roll their hit and run attacks. *See p.12 for more on Hit and Run attacks.*

When boarding torpedoes come in contact with any other torpedoes except other friendly boarding torpedoes, they will be removed as normal.

Boarding torpedoes do not attack friendly ships (including hulks) they come in contact with, nor are they removed by friendly fighters in contact.

ATTACK CRAFT

Attack craft are represented by 20mm square markers. When used in a wave, they must be spread and moved so they are always in contact with each other, and they cannot be stacked.

Attack craft waves must be assembled into the smallest circumference possible, such as a block of four, two rows of three, etc. For example, a single wave of eight ordnance markers cannot be stretched out into a single-file line eight markers long. On the other hand, individual markers not in a wave can be organized in any formation desired as long as no single marker moves farther from its launching vessel than its maximum possible movement.

Once separated, attack craft markers cannot be recombined into waves.

Attack craft can make as many turns as desired in the course of their movement, and they are not required to attack the closest target. They are assumed to be able to avoid or ignore closer targets or obstructions unless the course of their movement unavoidably brings them in contact, such as travelling through blast markers or celestial phenomena. When doing so, no part of the wave may move more than its speed. For example, you cannot gain extra speed by turning at the end of your movement making markers on the corner edge move further than the wave's maximum

speed. If you are intending on attacking at the fringe of your total movement, the player should measure the distance before moving the wave.

Attack craft can ignore any targets they are not actually in contact with, but they cannot “fly through” enemy ship bases to attack a desired target behind them. However, attack craft can select to target vessels with small bases “hiding” inside the footprint of a large ship base as long as the attack craft actually have the range to reach the smaller base (this is the only manner in which attack craft may ignore the first ship's base they come in contact with). Torpedoes still behave normally and cannot select targets in this manner (this includes boarding torpedoes or any other “special” torpedo type). Ships with bases stacked in this manner may mass turrets against ordnance as described in the relevant section.

When attacking ships, an assault boat or bomber wave that destroys a ship expends the entire wave to do so and is removed, even if individual markers have not yet rolled their attacks.

FIGHTERS: Fighters can escort a-boats in a wave in the same manner that they can escort bombers, though they offer no bonus to a-boat attacks. Fighters escorting other attack craft are always removed first when attacked before resolving any other attacks.

Fighters must always interact with ordnance they come in contact with for any reason. This includes attack craft that behave as fighters but fulfill other roles, such as Space Marine Thunderhawks or Ork fighta-bommas.

TORPEDO-BOMBERS: Fleets that do not normally have access to bombers also do not have access to torpedo bombers. Attack craft that function as both fighters and bombers (such as Ork fighta-bommas) lose their fighter ability when converted to torpedo bombers and function ONLY as torpedo bombers.

Ships that pay an extra cost to be equipped with torpedo bombers do not replace their bombers with torpedo bombers. When taken, torpedo bombers become an additional type of attack craft available to the carrier. Torpedo bombers always move no more than 20cm, regardless of how fast other bomber types move in a given fleet list.

Torpedo bombers may not launch their torpedoes (convert to a torpedo salvo marker) in the same ordnance phase they were launched from their parent carrier. This includes if they make contact with their target in the same turn they were launched. In such cases, use normal bombers instead if desiring to attack an enemy ship in close range.

RESILIENT ATTACK CRAFT

Attack craft that are “resilient”, meaning they have a 4+ save against other ordnance such as Thunderhawks or Eldar fighters, can only attempt this save once per ordnance phase, regardless of attacking or being attacked. Even if they roll a 4+ to remain in play, they have to stop movement where the ordnance interaction took place and cannot move further for that ordnance phase, and they lose their 4+ save for the rest of that phase as well (or movement phase if save is made while in CAP). In all cases, resilient attack craft that fail to make their save are immediately removed.

Resilient attack craft that behave as fighters must always do so when in contact with other ordnance, even if they may serve another function as well, such as Thunderhawks. Attack craft that do not function as fighters but have a save against fighter attacks, such as Tau Manta bombers, ignore any other type of ordnance except fighters in the same manner other bombers or assault boats do.

MULTIPLE ATTACKS: Any second interaction in the same ordnance phase such as attacking multiple markers in the same phase will cause the marker to be automatically removed, as normal fighters would be were they not resilient. The attacking player always decides the order of the ordnance interaction. For example, if two Thunderhawks move in contact with two Chaos Swiftdeath fighters, the Space Marine



player decides in which order the ordnance interacts. He can decide Thunderhawk #1 removes one fighter, makes its 4+ save and remains in play, then decide Thunderhawk #1 removes the second Swiftdeath, in which case Thunderhawk #1 is automatically removed but Thunderhawk #2 remains in play without using its save and can thus move full distance. Conversely, the Space Marine player may decide to engage the Swiftdeaths one apiece, in which case both Thunderhawks remain in play if they both make their saves, but both expend their saves for that ordnance phase in the process. In this case, both Thunderhawks end their movement where they came in contact in the Swiftdeaths and may not continue to move full distance.

OPPOSING RESILIENT ORDNANCE: If two markers that both have a 4+ save attack each other and both remain in play by successfully rolling their saves, they stop movement and remain in contact until the next turn's ordnance phase. However, if any marker that saves is attacked again in the same phase, it (along with the marker that attacked it) is automatically removed. Following is an extreme example:

1. Two Tau Mantas are attacked by two Eldar Darkstar fighters, and the Eldar player elects that Darkstar #1 attacks Manta #1, and both markers immediately stop all movement. If they both roll a 4+, both remain in play. If Darkstar #2 now attacks Manta #1, the Manta is automatically removed. If Darkstar #2 now rolls a 4+ save, it may remain in play but the Eldar ordnance phase is now complete because both ordnance markers rolled saves and can no longer move or attack.
2. It is now the opponent's turn to move his or her markers this ordnance phase. Manta #2 may now elect to move away from the two Eldar fighters because it itself is not a fighter and is not obligated to engage ordnance in play, or it may elect to remain in contact. If it does, it automatically removes one Darkstar fighter because both fighters already rolled their saves for that turn. If Manta #2 now successfully rolls its save and no other ordnance is on the table, the ordnance phase ends for that turn, and both it and the remaining Darkstar fighter remain in contact for the rest of the turn.

If a wave containing resilient attack craft attacks or is attacked and a save is made, ordnance markers that make saves may no longer move. However it may be split from the wave to allow the rest of the wave to continue its movement. Attack craft in the wave that were not attacked (and thus didn't use their 4+ save) complete their movement normally. For example, instead of ignoring it a wave of four Thunderhawks in the course of their movement attacks a single Ork Fighta-bomma not in base contact with a ship (rules for attacking ships with fighters on CAP remain unchanged). One Thunderhawk attacks the fighta-bomma, removing it. If it rolls its 4+ save it may remain in play, but it must stop where it made contact with the fighta-bomma and not move until the next ordnance phase. The remainder of the Thunderhawk wave may continue to move its full distance. In essence, the Thunderhawk marker that engaged the fighta-bomma peeled off the wave to engage it while the rest of the wave continued on to its target.

COMBAT AIR PATROL (CAP)

One or more fighter markers on CAP may elect to move with its ship in the Movement phase (thus remaining in base contact) to intercept ordnance that may be in its way, but if it does so it may NOT then move in the ordnance phase. In other words, no double moves. Fighters on CAP then stay on CAP for that turn unless removed. If when doing so they

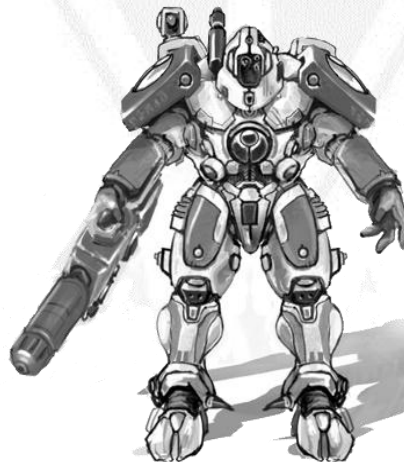

move farther than the attack craft can move normally in a single ordnance phase (such as 20cm Thunderhawks escorting a Cobra that moves 30cm), they then cannot move in the opposing player's ordnance phase as well, though they are still capable of defending the ship they are in base contact with normally.

An ordnance marker or wave is considered to move with the ship it is escorting and will protect the ship against enemy ordnance it encounters even in the midst of the ship's movement.

Multiple fighters on CAP in base contact with a single ship function as independent markers in all respects and are not a wave. When encountering blast markers, roll once per squadron marker. This includes if the ship is subsequently destroyed, at which time the fighter markers roll separately against the effects of the explosion. Any markers that survive subsequently act as separate ordnance markers and may move again in the subsequent ordnance phase.

Only fighters and ordnance markers that behave as fighters can be used as CAP. Bombers and attack craft cannot be used as CAP to protect against ramming or hit and run attacks by other ships the escorted ship encounters in its own movement phase. For example, a bomber can't be placed on CAP to escort a cruiser so that it immediately makes attacks upon an enemy ship the cruiser moves in base contact with. This includes resilient bombers such as Mantas.

Multi-role ordnance markers that can still act as fighters on CAP are capable of attacking ships (such as Fighta-Bommias and Thunderhawks) can only attack ships during the ordnance phase unless an attacking ship moves into contact with them during the enemy's movement phase. They may not otherwise attack a ship until they leave CAP first. See the following two examples:

1. An Ork Terror Ship with two fighta-bommias in base contact serving as CAP rams and/or boards an Imperial cruiser. The fighta-bommias it dragged along in the course of its movement do not automatically attack the Imperial cruiser as well but must wait until the ordnance phase, and even then may only do so if the attacking ship ends its movement in base contact with the

target vessel because attack craft that escort a ship in the movement phase cannot also move in the ordnance phase. If engaged in a boarding action and the Terror Ship ends its movement in base contact with the Imperial cruiser, the fighta-bommas may attack it in the ordnance phase before the boarding action takes place in the end phase.

2. An Imperial cruiser rams and/or boards an Ork Terror Ship that has two fighta-bommas in base contact serving as CAP. In this case the Imperial cruiser must follow all rules for moving in contact with enemy ordnance. After resolving the ram attack (if successful), the fighta-bommas immediately attack the Imperial cruiser and are removed. If engaged in a boarding action and the Imperial cruiser ends its movement in base contact with the Terror Ship, the fighta-bommas still resolve their attack immediately, before the boarding action takes place in the end phase.

NOTE: The same example would apply for other multi-role attack craft that behave as fighters on CAP, such as Thunderhawks. Note that because the markers are not in a wave, if a ship is destroyed by markers in CAP, no further markers are lost to attacking the destroyed ship.

Fighters and attack craft that behave as fighters can at



any time in their normal movement be placed on a friendly ship as CAP. However, only these types of attack craft can behave as CAP. Fighter-type attack craft must be split from attack craft in a mixed wave of ordnance that don't have the fighter rule before they can subsequently serve as CAP.

There are only two situations where fighters can leave CAP excluding their destruction. 1.) At the beginning of the owning player's movement phase. 2.) During the owning player's part of their opponent's ordnance phase. Note: If the attack craft on CAP is resilient, it still moves with the ship even if it has made a save.

Fighters on CAP and Other Friendly Attack Craft: It is possible to defend friendly attack craft by putting them within the perimeter of a ship's base that has fighters on CAP. Note: If enemy fighters intercept attack craft that are 'hiding' on a ship's base in this manner, they will not be repelled by turrets.

Fighters on CAP don't attack torpedoes or mines being launched from a friendly ship it is protecting or from friendly ships in base contact including when launching a massed torpedo salvo. However, they will defend against torpedoes and enemy mines in any other instance.

Resilient attack craft such as Manta bombers and Thunderhawks that end their movement in base contact with a ship escorted by CAP (meaning they are already in base contact with a ship when stopped by the fighter), use their 4+ save to survive the attack and subsequently survive against turrets may no longer move or attack other ordnance markers. However, they may complete their attack run against the target vessel normally as long as they do not have to move any more to do so. For example, two Mantas attack an Ork Terror Ship with a fighta-bomma in base contact serving as CAP

ORBITAL MINES

Once mines are in play, they are always active until destroyed. This includes individual mines purchased separately from a minefield as well as mines launched from modified carriers. Individual mines purchased separately count for victory points when

destroyed, regardless of how they are removed from play. Individual mines deployed from a minefield do not normally count for victory points when destroyed.

Toward friendly ships, a minefield behaves as an asteroid field in all respects, and they may traverse a minefield as they would an asteroid field normally. Foolhardy enemy vessels may attempt to do so using a leadership check as when traversing an asteroid field. Shields protect against hits from mines normally. Enemy ships inside a minefield will affect activating mines just as if they were outside the minefield normally, in which case they would be the first ship(s) targeted by any activated mines. If multiple enemy vessels enter a minefield and activate mines, the player owning the minefield determines which vessels activated mines attack first. *See p.14 for more about traversing asteroid fields.*

Attack craft are not large enough to activate mines and can hide in a minefield the same way they may do so in an asteroid field (destroyed in a D6 roll of six). Friendly attack craft (including fighters) will not attack activated mines. Torpedoes that contact a minefield are destroyed. A minefield blocks line of sight in the same manner as an asteroid field.

Orbital Mines and Launch Bay Strength: Orbital mines completely replace ALL the attack craft in a ships launch bays in a one for one manner. For example, an Imperial Dictator has four launch bays in total so if mines were taken it would have four mine launchers in total with no capability for other types of attack craft, though torpedoes would be unaffected.

For purposes of number of launch bays, mines count as torpedoes as opposed to attack craft in that as many mines may be in play as the ship is capable of launching. However, launch bays of ships carrying mines do not count toward the total number of launch bays in the fleet for purposes of ordnance limits.

MASSING TURRETS AND TURRET SUPPRESSION

Ships in base contact may mass turrets together, each increasing the turret strength of a ship under attack by 1. Regardless of how many ships are in base contact with each other, no single ship can mass turrets with

more than three others, providing a maximum of +3 dice when rolling turrets. The ships that mass turrets with a ship under attack take on the same ordnance restrictions as the ship under attack, such as using turrets to defend against either attack craft or torpedoes (not both) in a given ordnance phase. Only the ship actually being attacked can apply its own turret value as a negative modifier to bomber attack dice rolls.

Ships that are braced can mass turrets and have turrets from other ships massed to defend it. Ships that are crippled cannot mass turrets but can have turrets from other ships massed to defend it.

No more than one ship can be moved at a time for any reason; ships will only be able to benefit from massed turrets after or before the movement phase is complete but not during. This does not affect how and in what order ships escorted by CAP are moved. An extremely unusual circumstance may occur where a ship extremely near to but not actually touching an enemy ordnance marker has a friendly ship move in base contact with it while it simultaneously contacts the ordnance marker. In this and ONLY this case can it then mass turrets while moving!

TURRET SUPPRESSION: Each fighter in a wave of bombers actually attacking a ship will add +1 attack to the total attack runs of the wave, regardless of whether they are shot down by turrets or not. The maximum number of bonus attacks that can be added in this way cannot exceed the number of surviving bombers in the wave. There must be at least one surviving bomber in the wave after turret fire to gain these bonus attacks, and fighters are removed before any other type of ordnance. Fighters that never made it because they were intercepted by defending fighters (even those on CAP) don't add to this suppression bonus. See the following examples:

1. An Emperor battleship (foolishly) launches a single wave of three bombers and five fighters against a Devastation cruiser with three turrets and no CAP. The Devastation's turrets roll 4,5,6 to knock down three fighters. The three bombers now *each* roll 1D6-3 (minimum zero) attacks regardless of whether or not any of the fighters survived against turrets. Now only three of the

five fighters that escorted the bombers provide an additional+1 attack because there are only three bombers in the wave, for a *single* total addition of +3 attacks.

2. An Emperor battleship launches a single wave of four bombers and four fighters against a Devastation cruiser with three turrets and no CAP. The Devastation's turrets roll 4,5,6 to knock down three fighters. The four bombers now *each* roll 1D6-3 (minimum zero) attacks regardless of whether or not any of the fighters survived against turrets. Now all four of the fighters that escorted the bombers provide an additional+1 attack because there are four bombers in the wave, for a *single* total addition of +4 attacks.

NOTE: See p.25 for how Ork fighta-Bommas work slightly differently when suppressing turrets as applied to the preceding example.

Turrets always reduce bomber attack runs, even if they have been used to defend against torpedoes and thus cannot be used against attack craft.

Massed Turrets and Ships with 0 Turret Strength: A ship with 0 turret strength (such as Eldar or hulked vessels) cannot offer a bonus to massed turrets, but may itself benefit from massed turrets from a ship with turret strength 1 or more. This applies both to ships desiring to defend a friendly hulk or a fleet defending an allied Eldar vessel.

RAMMING, BOARDING AND BASE SIZE

RAMMING: Damage from ramming is not deflected by a ship's shields.

When ramming defenses, they always roll their full number of starting HP to damage the ramming ship as if prow-on, as defenses are more solidly built than ships are.

As Battlefleet Gothic is a 2D representation of 3D space, a ship cannot attempt to ram more than one ship per movement phase, even if multiple enemy vessels are in its range of movement.

When the All Ahead Full roll command check is passed, the owning player must declare which ship it is attempting to ram and make the appropriate leadership test to do so before rolling the number of additional D6cm it will move All Ahead Full. This choice cannot be changed if the ramming ship ends its movement in base contact with more than one vessel or does not reach the intended vessel. The number of ships it "moves through" or ends in contact with does not change or alter this. See p.8 for how having ordnance on CAP affects ramming attacks.

As ramming already requires a dedicated leadership check, a ship does not have to make a separate leadership check to ignore closer targets to ram one further away, just as attack craft do not have to do so to attack a given target.

Movement distance and contact when attempting to ram is determined by base-to-base contact. If any part of the ramming ship's base contacts any part of the rammed ship's base in the course of its movement, the ram is considered to be successful.

When ramming, the ramming vessel must move its FULL distance, including any extra distance moved for being All Ahead Full. When ramming, calculate damage taken by both vessels immediately. If the ramming ship survives (even as a hulk), then it completes its movement.

If either ship is destroyed and explodes due to ramming the explosion (and any subsequent hits) is resolved at that moment. The ramming and rammed ship will both always be in the explosion. If it was the rammed ship that exploded it is easier to finish the ramming ships movement as normal, but unless it has special rules to navigate blast markers it will be slowed by blast markers from the explosion.

While a ramming vessel may later attempt to board or shoot, it may only attempt to board a vessel if it ends up in base contact with one at the end of its full movement. This does not necessarily have to be the same vessel it just rammed.

Once the All Ahead Full command check is rolled normally, there are four sizes concerning the separate leadership check to ram. From biggest to smallest:

Defence > Battleship > Cruiser > Escort. The worst this test can be is on 3D6 and the best it can be is on 1D6. Using this type order, a ship must roll 2D6 to hit a ship the same size, 3D6 to hit anything smaller, and 1D6 to hit anything larger. This type order is not related to the size of the vessel. For example, an Ork Rok would need to pass a leadership check on 3D6 against an escort, cruiser or battleship, and 2D6 to ram another Rok or other defense. Likewise, an escort would only need to roll 1D6 to ram anything larger than another escort, for which it would need to roll 2D6.

BOARDING ACTIONS: Under no circumstances may a player initiate a ship-to-ship boarding action during the enemy's turn, though it may defend against an enemy boarding action normally. *See p.8 for how having ordnance on CAP may affect boarding actions.*

Blast markers in base contact with vessels engaged in a boarding action only provide a negative modifier to the ship or ships actually in base contact with the blast marker. Both vessels are affected only if both are actually in physical base contact with blast markers. See the Tyranid section on p.29 for how this differs for that fleet.

While turret strength is applied to ascertain a ship's boarding value when defending against a boarding action, turret strength is not part of a ship's basic boarding value. So if the ship is defending and has a bonus, like having its value doubled by the Mark of Khorne, the value doubled is the ship's remaining hit points. The turret strength is added after and is not affected by this.

Apply boarding modifiers in the following manner. The boarding value is your remaining hits, modified by any special rules that apply to your ship or race, such as the Mark of Khorne doubling its boarding value, or Tau Kor'vattra vessels which have their value cut in half. (To this value add afterward the number of turrets only if defending against boarding). It is this value that offers a +1, +2, +3 or +4 boarding modifier for how much larger one ship's value is against another (applied once, and only the highest modifier). To this resulting value apply all additional modifiers, such as having blast markers in contact,

being Orks or Chaos, etc, as listed on p.34 of the rulebook, depending on the combination of modifiers you have. The totals of these modifiers are applied to your single boarding dice, which is then rolled against a roll similarly modified by your opponent. The winner is the player with the highest modifier +D6 (boarding dice) roll, causing damage equal to the difference of these totals. This sum is NOT limited to 6 and can potentially result in a roll of up to 12 or more, such as a +4 modifier for being four times as large as the enemy and +2 for being Space Marines applied to a D6 roll of 6.

When conducting a multiple-ship boarding action as per p.34 of the BFG rulebook, the attacking player may elect instead for each capital ship or escort squadron to roll separately. In this case the defending ship must roll separately against each attacker and the damage it takes is cumulative, but each attacking ship or escort squadron must modify its boarding roll based only on its own value, not on the values of the other ships and escort squadrons it is combining with in the action.

Race modifiers are only counted once, so if both a Chaos Murder class cruiser with a normal Chaos crew and a Devastation class cruiser with a Chaos Space Marine crew boarded an Imperial cruiser together they would get a +2 race modifier, the +1 from being Chaos being superseded by the +2 for having a ship with a CSM crew. This is in addition to the +1 for the two ships having a higher boarding value than the ship being boarded (it is not twice the boarding value because the ship being boarded gets to count its turret value) for a total of +3 for the Chaos player. This is *also* not taking into account whether or not any of the ships have any other modifiers that must be added or subtracted into the total or effects that either halve or double their respective boarding values, whether or not ships are braced, crippled, etc.

BASE SIZE: Any ship or defense with either 3 or more shields OR greater than 10HP must use a large size base. However, any capital ship can elect to use a large base and is considered to have Tractor Fields for free. Tractor fields have no effect except making it easier for the ship to ram and/or board due to its



larger base size, in exchange for being a larger ordnance target.

HIT AND RUN ATTACKS AND CRITICAL DAMAGE

Teleport attacks can be conducted by capital ships that are on Lock-On or Reload Ordnance special orders. All other special orders preclude the use of teleport attacks. *Necron Portals are not teleport attacks in the normal manner; see p.27 for details.*

Ships that cannot be boarded (such as Chaos vessels with the Mark of Nurgle) are NOT automatically immune from hit and run attacks.

Fleets that benefit from a +1 bonus to their Hit and Run attacks roll a 2 to 7 on a D6, meaning they will never fail to inflict some critical damage on their target when attacking capital ships.

Due to their much smaller size, escorts do not have a specialized critical table. Instead, all hit and run attacks (including assault boats and teleport attacks) destroy escorts on a roll of 4+ as opposed to 2+. Fleets that enjoy a bonus to their hit and run rolls still benefit from this bonus, needing a 3+ to succeed in



hit and run attacks against escorts. Fleets that enjoy a -1 modifier to enemy hit and run attacks benefit in this regard as well, meaning hit and run attacks require a 5+ to destroy their escorts. Anything that rolls 2D6 and adds the result during a hit and run attack still do so, such as Dark Eldar Impalers, in which case the added result still normally (before any modifiers) destroys an escort on a roll of 4+, though they must roll 2D6 twice and take the lowest roll against Tyranids. *See p.28 for more about Tyranids.*

Critical hits that can be repaired are cumulative; meaning ships that take a multiple number of the same critical damage must repair all incidences of that critical damage before the system is fully operational.

A ship's speed is only affected once by multiple Thrusters Damaged criticals. However, the number of times it takes effect are still cumulative, and all Thrusters Damaged criticals must be repaired for the ship to regain its normal speed.

Damage from multiple fire criticals is cumulative. Example: if a ship had 3 fire criticals and failed to repair any of them in the end phase, it would suffer 3 points of damage and all three fires would keep burning.

Critical hits that cannot be repaired such as Shield Collapse only count once. Subsequent instances of this damage instead move to the next higher applicable critical damage. For example, a second Bridge Smashed critical damage on a given ship

instead causes a Shield Collapse, or a Hull Breach if the shields are already collapsed.

CATASTROPHIC DAMAGE

Ships that are reduced to zero hits and become hulks no longer have shields, holofields or any other similar mechanism.

Moving Drifting/Blazing Hulks: The owning player moves his or her drifting Hulks in which ever order the owning player wishes. Roll to determine if a blazing hulk explodes at the end of the player's movement phase, not at the end of its own movement.

Drifting / blazing hulks are affected by blast markers and other speed modifiers, and they can be damaged by blast markers they move through on a D6 roll of 6. This does NOT include the blast marker blazing hulks place at the end of their movement.

Drifting/Blazing Hulks and Gravity Wells: When a drifting/blazing hulk enters a gravity well it must make any extra turns that are conferred to it towards the center of the gravity well. In the case of a Space Hulk's gravity well the drifting/blazing hulk makes its compulsory turns as above and is merely removed from play if its base makes contact with the Space Hulks base. If it was a blazing hulk when removed in this way, roll once on its catastrophic damage table before its removal.

The turret value of a hulk is reduced to zero, and turrets have no effect. Bombers do not subtract the hulk's turret strength from their attack runs.

Hulks cannot be fired upon or boarded by friendly vessels or ordnance in an attempt to deny victory points to the enemy or induce catastrophic damage. Torpedoes that hit a friendly hulk still inflict hits normally, but torpedoes cannot be deliberately aimed at friendly hulks.

While enemy ships can choose to fire on a hulk, they do not have to pass a leadership check to ignore one if it is the closest target. A player can fire on an enemy hulk if it is not the closest target, but it must make a leadership check normally.

When shooting at hulked ships, roll once on the catastrophic damage table each time hits are inflicted by shooting or ordnance from a given ship, squadron or ordnance wave (regardless of the number of hits inflicted), not once for each additional hit inflicted.

Exploding ships count as an area effect and cannot be saved against by holofields, though shields still work normally. *See p.5 for more on area effects.*

When placing an exploding ship's blast markers, place a single blast marker exactly where the ship was, and then place as many blast markers from the explosion as possible fanning around and in contact with it until the total number blast markers are placed without overlapping any blast markers.

SQUADRONS

Before the start of a game, escort squadrons make a single roll to determine leadership for the entire squadron. Capital ships may roll their individual leadership separately before forming squadrons, but capital ship squadrons must be deployed and declared as such before the start of the game. A capital ship squadron assumes the leadership of whatever surviving vessel has the highest leadership.

Vessels in a squadron are all equally affected by special orders taken by any one ship in the squadron. For instance, when on All Ahead Full, only one roll is made to determine additional move distance for all the vessels in the squadron. As is true for individual ships, squadrons can only undergo one special order per turn (including Brace For Impact, which replaces any Special Order currently in effect). All ships in a squadron are affected by Brace For Impact, not merely the ship actually taking fire. This includes capital ship squadrons! *See p.2 for more about leadership modifiers for capital ship squadrons.*

ESCORT SQUADRONS: An escort squadron that successfully disengages only counts as being 10% destroyed against the full value of all the escorts in the squadron. It counts as 25% destroyed if the squadron was crippled before disengaging, as in if at least half the escorts in the squadron were destroyed (rounding down) before the squadron disengaged. For example, if a squadron of five escorts disengages

after two were destroyed, the enemy only gains 10% of its starting value, but will earn 25% of its starting value of three were destroyed before it disengaged. *See the following page for more on disengaging escort squadrons.*

Hits taken by a squadron are only distributed among the vessels that actually took fire (such as in range and fire arc), regardless of how many hits the squadron actually took, though it affects ALL escorts within range and fire arc. This also applies to hits taken by an escort squadron negotiating an asteroid field, as well as hits delivered by ordnance or Nova Cannon, as those hits (regardless of how many) affect only the vessels directly contacted by the ordnance markers or Nova Cannon blast template. For example, if an escort squadron takes a total of ten hits from gunnery fire but only three escorts were actually in range and fire arc, no more than three escorts can be destroyed.

CAPITAL SHIP SQUADRONS: Capital ships in a squadron that are being fired upon to the point that one of the capital ships is destroyed must roll for and apply all critical damage before counting as destroyed. The easiest way to avoid confusion is to roll each D6 critical roll separately while recording damage. For example, if a squadron of three Dauntless light cruisers is fired upon by a squadron of three Carnage cruisers and takes a total of 13 hits, all critical damage rolls must be made for the first Dauntless before declaring it destroyed. This means if while applying hits one at a time and the first Dauntless rolls a Thrusters Damaged (+1Hp) and Engine Room Damaged (+1Hp) criticals in the process of being destroyed, there remains a total eight remaining hits to be applied to the next closest Dauntless light cruiser, with shields, blast markers, etc. still taking effect normally, for a total of seven Hp damage to the second Dauntless, against which it rolls a D6 to check for critical damage while applying hits one at a time (after the shield hit). This means at least one hit would pass to the third Dauntless even if the second rolled no critical damage. This rule in particular applies to squadrons of ships that do not count critical damage normally and instead take an additional 1Hp of damage, such as Ork Roks or Kroot

Warspheres. **NOTE:** *See p.14 for more on how asteroid fields can damage capital ship squadrons.*

If a capital ship squadron disengages in its entirety, each capital ship calculates its percentage destroyed for victory points separately and not in the same manner as escorts. *See the following page for more on disengaging capital ships.*

SHOOTING BY SQUADRONS: When calculating the ships' firepower individually as indicated on p.38 of the rulebook, this only applies to ships firing at different firing arcs. To clarify the example on p.39 of the rules, if a squadron of five Sword frigates are firing on a cruiser where two are in its rear arc and three are in its beam arc, the two escorts behind it would calculate their firepower together as Moving Away, and the three on the ship's beam would calculate their firepower together as Abeam. Then these two sums are added together before making the dice roll. *See p.3 for more on using the gunnery table.*

SHOOTING AT SQUADRONS: When shooting at a squadron you have to shoot at the closest target first. This does not apply to ordnance attacks. A leadership test cannot be used to pick out individual ships in a squadron; only the closest vessel can be targeted. This is an intended game mechanic. Note that when shooting at squadrons with gunnery attacks, facing and armor values all take effect as described on p.38 of the rulebook. The only ways to shoot at a more distant member of a squadron is with gunnery weapons if the ship has more left modifiers on the gunnery table or has weaker armour where only the hits that could not hurt the closest target hit it. If because of weaker armour, armour ignoring weapons cannot exploit this rule. As ships in a squadron are destroyed by incoming firepower, remaining shots are immediately applied to the next closest ship in the squadron. This only applies to shooting and does not apply to ordnance attacks, boarding actions, etc.

DISENGAGING

A vessel not hulked that moves off of the table edge during play for any reason counts as being disengaged.

If any single ship in an escort squadron disengages, the whole escort squadron must then immediately and in subsequent turns attempt to disengage following normal rules. This prevents an escort squadron from disengaging one or two vessels to keep leadership or victory point benefits, then pushing the rest of them in a suicide run at the enemy. *See the previous page for more on escort squadrons.*

Capital ships in a squadron may disengage separately, relying on their individual base leadership to do so, not the highest leadership in the squadron. If it attempts to disengage and fails, it falls out of the squadron and may not attempt to re-join it. This is in addition to all other effects listed on p.33 of the rulebook for ships that fail to disengage when attempting to do so. *See the previous page for more on capital ship squadrons.*



When disengaging, ALL positive and negative modifiers must be added together before determining the leadership check, even though check rolls of 11 or 12 still automatically fail. For instance, a ship or escort squadron with Ld9 attempts to disengage after moving within 5cm of three blast markers and an asteroid field (+4Ld) with no enemy ships or ordnance markers within 15cm (no negative modifier). Even though the effective leadership to disengage is now Ld13 because these must all be added together BEFORE the roll, the player must still roll no higher than 10 to not fail the check.

A ship that disengages successfully counts as 10% its point value for the enemy, or 25% if it is crippled before it disengages. This is NOT in addition to the 25% victory point value if it remains on the table at the end of the game but is crippled.

In addition to victory points earned normally, a player only earns additional victory points (+1 renown) equal to 50% of the value of ANY hulk left on the table (including any refits or an embarked commander) if the ship remains as a hulk on the table and the winning player holds the field as described on p.66 of the rule book.

CELESTIAL PHENOMENA

Solar flares now only occur once per game. Rolling multiple instances as celestial phenomena during set-up only means there is a higher likelihood one will occur, meaning you still roll a number of D6 at the start of the turn equal to the number of instances the celestial phenomena occurred in set-up. However, only one will actually manifest itself during the game, after which no more rolls are made before the movement phase.

Fighting sunward is only of consequence in the Flare Region, Mercurial Zone and Inner Biosphere. To determine if you are shooting sunward place the bearing compass over the firing ship with the arrows parallel with the sunward edge. If the target is within the arc facing the sunward edge you are shooting sunward.

Free turns provided by gravity wells can be used even when the ship cannot normally turn, such as when under All Ahead Full or Lock On special orders. They can also be combined with Come To New Heading special orders to provide additional turning opportunities. This does not change the fact that the free turn can only be used before the start of the move and again only at the end of the move. In either or both instance(s) the ship must actually be in the gravity well to use it, and the free turn is only toward the center of the planet's or moon's gravity well or toward a space hulk's stem or no more than 45 degrees, whichever is less. See pp.2-3 for more on special orders.

Flying Bases and Terrain Interaction: Any celestial phenomena affects a ship as soon as it contacts a ship's base. However, it does not block fields of fire unless it physically blocks line of sight from the stem of the shooting ship to the stem of the target ship.

If a ship having 0 shield strength explodes due to contact with a gas/dust cloud, the explosion will originate at the point the ship entered the cloud.

Ships on a Planetary Template: When a ship's stem is actually on a planetary template (as opposed to behind it), the template does not block its line of sight or any ships line of sight to it. If multiple ships are on a planetary template, they can all see each other.

A ship counts as being upon a planetary template if its stem touches the template, not merely if it is in base contact or if its base partially overlaps the template.

Torpedoes on a Planetary Template: Torpedoes are only destroyed when they come into contact with the template's edge, either when launching them toward the planet or from it by ships in high orbit upon the template itself. It is possible to launch torpedoes while on a planetary template but they will be removed when they touch its edge. See p.6 for more on launching torpedoes.

Multiple Radiation Bursts: Only one radiation burst can happen per turn even if multiple radiation burst were rolled for. If three radiation burst were rolled as celestial phenomena during start-up, 3D6 are rolled per turn, with a radiation burst taking place if any one D6 rolls a 5+. Note: You roll every turn until the end of the game for radiation bursts, making it possible for a radiation burst to occur every turn from one radiation burst result on the Flare region or Mercurial zone generators.

ASTEROID FIELDS: Ships moving through an asteroid field, or coming into base contact with the

edge of one, must pass a Leadership test on 2D6 to navigate it successfully. Ships using *All Ahead Full* special orders make the test on 3D6 instead. Escort ships may re-roll the Leadership test if they fail it, but the second roll stands whether it is successful or not. A ship that fails the Leadership test suffers D6 damage from asteroid impacts, but its shields will block damage as normal.

Escort and capital ship squadrons make this leadership test normally, once for the whole squadron. In the case of capital ship squadrons that fail this test, each ship that comes in base contact with the asteroid field in any way suffers D6 damage. Escort squadrons re-roll this leadership test for free. In the case of escort squadrons that still fail this re-roll, D6 damage is distributed among the escorts that actually contacted the asteroid field, in the order that the ships were moved. In all cases, shields (but not holofields) work normally against hits. See p.13 for capital ship squadrons.

Blast markers are not placed when asteroid impacts take shields down, however the ship will be slowed down 5cm as if it has moved through blast markers that turn.

Ships cannot shoot into or out of an asteroid field. However, shooting between ships inside an asteroid field can take place only if both the shooting and target ships are both inside an asteroid field. Lances and weapon batteries have no more than 10cm range, Nova Cannons don't work and torpedoes of any type cannot be used. Shooting at enemies within 10cm range does not impart a right column shift when inside an asteroid field. Attack Craft work normally but must make a D6 roll every ordnance phase they remain in the field, with every wave or individual marker removed on a roll of 6. Ships that are braced or crippled may not shoot inside an asteroid field. Asteroid fields are treated as minefields if you wish to shoot at them. You must first pass a leadership test to shoot an asteroid field even if it is the only possible target, with a blast marker placed in contact with the asteroid field facing the direction the shooting came from for every roll of 6.

As warp drive implosions are not affected by celestial phenomena for purposes of line of sight, this includes



when it takes place inside celestial phenomena such as asteroid fields. Being inside, outside or the other side of an asteroid field from an exploding ship does not affect whether or not it is in the explosion's 3D6cm blast radius. *See p.5 concerning area effects and celestial phenomena.*

PLANETARY DEFENSES

Orbital defenses or ships that count as defenses may be placed in squadrons, with IHP defenses grouped in up to six units and larger defenses grouped in up to four. A Ramilies Star Fort cannot "squadron" with other orbital defenses.

Stationary planetary defenses may be placed in base contact if desired, but they can never be stacked or have their bases overlap other stationary planetary defenses.

When desired, the defender in a scenario may spend up to one-third of his allocated point value on planetary defenses, in addition to any planetary defenses provided by the specific scenario. This allows for the use of larger planetary defenses such as major fleet bases and the like, for which the profile and point cost of an Imperial Blackstone Fortress on p.145 of the rulebook may be used. However, these additional defenses come directly from the points allowed against his or her fleet list.

Stationary defenses and vessels used as planetary defenses such as Defense Monitors or system ships do not roll for leadership or have a leadership value just as other normal planetary defenses do not, with the exception that they reload ordnance (where applicable) on a nominal leadership of 7 unless specifically stated otherwise in their fleet lists or special rules. This means that they cannot take on any special orders except Reload Ordnance, though they may also attempt to Brace For Impact against this same leadership. They also make all other leadership checks they may have to make against Ld7, such as for navigating celestial phenomena and for ignoring closest targets.

Ships that are targeted as defenses but otherwise are not normally restricted to planetary defenses, such as

Ork Roks, Kroot Warspheres, etc., are treated as ships and can make Special Orders normally.

When shooting at minefields, treat them as ordnance for purposes of target priority.

BLAST MARKER REMOVAL: You remove D6 blast markers from each defence with a speed of 0cm in each end phase after all other actions in the end phase. This only applies to stationary defenses, not planetary defenses that behave as ships (such as monitors or system ships). This also does not apply to ships on standby or ships reduced to 0cm due to movement effects but otherwise capable of movement.

WARP RIFTS: Warp rifts are especially unstable and dangerous forms of celestial phenomena, and planetary defenses of any type cannot be placed closer than 30cm to a warp rift, with all other rules still applying normally. This means if a particular defense must be placed within 15cm of celestial phenomena, it still must be so placed, and it can't be placed within 30cm of a warp rift.

TRANSPORTS

Transport Variants in Scenarios: The Transport variants listed in Armada and other fleet lists are not only intended for the Convoy scenario, and they may be taken in other scenarios that call for the use of transports in the scenario rules.

Any special transport such as an armed freighter or fast clipper in Armada or any other fleet list that counts as half a transport for victory conditions is also only worth 1 assault point. Two of these vessels are equivalent to a single regular transport, and such vessels round down for purposes of victory conditions. For example, if victory conditions require at least one regular transport to survive the battle and only a single special transport survives, its transport value rounds down to zero.

By definition, a fast clipper is a special transport (counting in all other respects as an armed freighter on p.160 of Armada) that gives up all its weapons batteries for a +5cm speed increase and a total of +5D6 (no more) when on All Ahead Full special

orders. Its point cost and profile for turning, shields and turrets remains unchanged. This ship can be used by any fleet that has access to the vessels listed on p.159-160 of Armada.

Heavy transports on p.160 of Armada are worth two regular transports or 4 assault points. If they are crippled, they are worth one regular transport or 2 assault points. Heavy transports count as cruisers for purposes of movement and are destroyed if they land on a planet's surface.

The price for heavy transports is not free; it is 40 points because of their great resiliency in comparison to escort-sized transports. This is in addition to the rule on p.159 stating no more than one third of the transports in your fleet can be heavy transports, in scenarios that require transports. To clarify, "no more than one third" refers to the entire transport value. For example, if a particular scenario calls for a total of six transports, no more than one heavy transport can be taken, since each one counts for two transports. For every heavy transport in the fleet there must already be at least four escort-sized full transports, eight half-transports such as armed freighters or Rogue Trader cargo vessels, or any combination thereof.

Any published resource referring to Q-ships should show them as having two shields in their profile for no change in cost. Q-ships have no transport value.

Escort carriers count as a special transport for purposes of use in scenarios that call for transports, but they have no transport or assault point value for purposes of determining victory conditions. Escort carriers cannot launch orbital mines.

GENERAL FLEET RESTRICTIONS AND OPTIONS

Attack Ratings: Attack ratings for the races in Battlefleet Gothic are normally as follows:

Imperial: 2

Chaos: 2

Tau: 2

Orks: 3

Craftworld Eldar: 3

Space Marines: 3
Tyranids: 3
Corsair Eldar: 4
Dark Eldar: 4
Necrons: 4

Fleet Commanders: A fleet with a total points value of more than 750pts must be led by a Fleet Commander unless specifically stated otherwise in the fleet list.

Fleets of Escorts and Fleet Commanders: If your fleet list doesn't allow you to field a Fleet Commander on an escort you must have a capital ship in a fleet of more than 750pts.

Using Single Escorts: A single escort may be taken in a fleet as long as there are no other escorts in the fleet. Note: If there are other restrictions due to the fleet list, such as a minimum of six escorts in a squadron, these restrictions cannot be ignored. If any more than one escort is taken in a fleet list, then all escorts must be formed in squadrons of at least two or whatever minimum is required by that particular fleet list. This also means if an escort squadron is limited to six ships and the fleet list has seven escorts, the escorts must be divided so no escort is operating without at least one other escort in a squadron. This rule exempts escorts that are allowed to operate alone, such as transports or Tau Messenger ships.

Escort squadrons reduced to a single escort in the midst of a battle may continue to operate singly for the duration of that battle, but afterward (in a campaign) must immediately be repaired or reinforced to include at least two escorts.



Class Variants: Some ship classes have variants listed in their notes, such as the Imperial Dauntless being able to exchange its lances for torpedoes. Unless specifically noted as unique by their fleet lists, such as the Chaos Planet Killer or the named Ork battleships, you may take multiple examples of any class variant.

RESERVE FLEETS AND REINFORCEMENTS

Any fleet chosen from one of the fleet lists may also include reserves. This applies to fleets in the rulebook, Armada or any other official fleet list, such as those on the Games Workshop's Battlefleet Gothic Resources website. For every three battleships, cruisers or escorts chosen from the fleet list, you may also pick one ship of the same type from another fleet list belonging to the same race. For example, or every three cruisers picked from the Gothic Sector Fleet List on p.115 of the rulebook, you may pick one cruiser from the Segmentum Solar Fleet List on p.27 of Armada, from the Adeptus Mechanicus Fleet List or from any other published fleet list. Only ships of the same "type" (battleship, cruiser or escort) count for reserves purposes so you can't pick three escorts from one fleet list and use them to qualify for a battleship from another. Also, for these purposes light cruisers, cruisers, heavy cruisers, battlecruisers and grand cruisers all count as "cruisers," so that three cruisers from one fleet list would qualify you to take a grand cruiser from another fleet list of the same race as a reserve. Reserves are still subjected to restrictions on minimum and maximum numbers of certain types of vessels. For example, having three

Chaos cruisers (such as a Murder, Carnage and Devastation) entitles a 12th Black Crusade Incursion Fleet to have a Repulsive grand cruiser. It also entitles the fleet to have one reserve cruiser such as the Executor grand

cruiser, but that ship cannot be taken because you must have at least six cruisers to have two grand cruisers, not merely three.

Reserve vessels may take any upgrades, refits, etc. available to either fleet list but may not take any special characters from the reserve fleet list to use with the primary fleet. For example, a player using the 12th Black Crusade fleet list with at least three cruisers can take a Retaliator grand cruiser as reserves from the 13th Black Crusade fleet list and upgrade it to take Chaos Space Marines, but that ship cannot take a Chaos Lord from the 13th Black Crusade list (a special character). Instead, it would have to use one of the only three Chaos Lords allotted to an Incursion Fleet list, though that Chaos Lord could have any of the Marks allowed by the Incursion Fleet List for the cost indicated on that list.

Reserve fleets are those specifically described as such in their fleet lists, not merely those identified as being capable of allying with each other. Reserve vessels taken at the start of a battle or earned as reinforcements in the course of a campaign must come from the same "race." For the purpose of this FAQ/Errata, the races are Imperial Navy (including Adeptus Mechanicus), Space Marines, Chaos (including Chaos Space Marines), Eldar, Craftworld Eldar, Dark Eldar, Orks, Necrons, Tyranids and Tau (including Tau allies). Some fleet lists explicitly provide access to ships from other races. These may only be taken exactly as described on their fleet list rules and may not also be taken as reserves. See the following examples:

1. An Imperial Navy fleet taken from the Segmentum Solar fleet list can take Space Marine vessels as part of its fleet list, even though Space Marines are technically from another "race." However, a Gothic Sector fleet list cannot take Space Marine vessels as reserves, even though it can take as reserves other Imperial Navy vessels from the Segmentum Solar fleet list.
2. The Demiurg and Kroot have specific rules allowing them to be used by various other fleets as allies in the same manner those fleets can take reserves. However, the Tau Kor'vattra fleet list allows a far more liberal use of Demiurg vessels

in the fleet. In this case, Demiurg vessels may be taken as provided for in the Tau Kor'vattra fleet list irrespective of limitations that would normally be placed on using reserves.

A given fleet may take ships as reserves from any number of fleet lists that are the same race that allow their vessels to be used as reserves. For example, a Gothic Sector fleet list with six cruisers may take both a grand cruiser from the Imperial Bastions fleet list on p.29 of Armada and a battleship from the Adeptus Mechanicus fleet list. However, a given fleet list cannot take as reserves ships listed as reserves or allies to another fleet list. For example, a Chaos Repulsive grand cruiser is listed as reserves for the Imperial Bastions fleet list, and the Armageddon Sector fleet list has Space Marine vessels as allies. Because it is listed only as reserves of that list, a Repulsive grand cruiser or Space Marines strike cruiser cannot be taken as a reserve vessel for any other Imperial fleet list. In short, you cannot use a reserve of a reserve. Reserves can only ever be ships belonging to the same race, chosen from a fleet list of the same race.

These allowances and restrictions apply for both one-off battles and while earning reinforcements in the course of a campaign. However, ships or special characters added to a fleet list as a special reward or through special scenario or campaign driven circumstances are exempt from meeting fleet prerequisites beforehand. For example, an Imperial fleet is allowed to immediately have a single Space Marine battlebarge in its fleet list in the course of a campaign with no fleet prerequisites and regardless of reserves if it expends an appeal roll against the Space Marines table on p.157 of the rulebook and rolls a 2D6 roll of 2, even if that fleet is not from the Segmentum Solar fleet list.

ALLIES, SUBJECTS AND MERCENARIES

Some fleet lists have explicit access to ships from other races. The Tau in particular have access to ships from several different races simultaneously. These may only be taken exactly as described on their fleet list rules and may not also be taken as reserves.

Allied and reserve vessels cannot use refits and upgrades from the fleet list they are allied to unless they are of the same race or the rules for that fleet specifically allow it.

Instead of a named reserve fleet listed in the rules of various fleet lists, vessels from certain fleets may elect for whatever reason to form permanent or temporary alliances with other fleets. The outcome of the Gothic War in particular hinged on a hasty, short-lived alliance between the Imperial Navy and the Eldar. Some ships in particular have rules that allow them to ally with any number of fleets or even fleets on both sides of a battle, such as the Demiurg on pp.109-111 of Armada. In all cases these follow the standard rules for reserves in that no more than one allied vessel may be taken for every three core vessels in the fleet.

Unless specifically described otherwise in a particular fleet list (such as Demiurg ships in a Tau fleet), the same restrictions that apply to reserves also apply to allies regarding ship types, (escorts, cruisers, battleships, etc.). Finally, this list does not supersede any specific ship or fleet restrictions, such as the Craftworld Eldar having access to the Corsair Eldar fleet list as reserves (and vice versa) only when the fleet is led by an Eldar Hero aboard the *Flame of Asuryan*, or that three Dark Eldar escorts must be taken in a fleet in order to have one Dark Eldar capital ship. Allied vessels taken in this way cannot be placed in squadrons with vessels in the core fleet unless specifically allowed to in the core fleet's list, nor can they use the core fleet's re-rolls unless specifically allowed to.

Just as a fleet can take any number of reserves as long as restrictions are followed concerning the number taken compared to the core fleet list (typically in a ration of no more than one for three unless listed otherwise in a given fleet list), the number of allied vessels the fleet takes is only limited by the rules applied to the allied fleet as long as all other restrictions concerning reserves are also followed.

In addition to these restrictions, no vessel can be allied to a fleet for which it is a natural enemy, nor can it ally itself to a fleet that already contains allies

for which it is a natural enemy. In the convoluted universe of Battle fleet Gothic there are many races that are natural enemies of each other. Any fleet that is natural enemies with another given fleet will also not ally with ships allied to that fleet, even if they normally would not be enemies of that fleet. In all cases this is provided only as a guide as opposed to any requirement that such fleets must ally with each other, and it is just as plausible that any one of these will be enemies of and combat any other. It is easier to list enemies than possible allies, but in the end this list is to be treated as a guide for what fleets may ally with each other, detailed as follows:

1. Imperials (including Adeptus Mechanicus): will never ally with Chaos, Dark Eldar, Craftworld Eldar and Orks. If it allies with or has as allies the Space Marines, it cannot ally with or take as allies ships from any other fleet list except Rogue Trader vessels (excluding Xenos ships).
2. Chaos (including Chaos Space Marines): will never ally with Imperials, Craftworld Eldar, Corsair Eldar, Space Marines or Tau.
3. Tau: will never ally with Orks, Chaos, Dark Eldar or Space Marines.
4. Dark Eldar: will never ally with Imperials, Tau or Space Marines.
5. Craftworld Eldar: will never ally with Imperials, Chaos, Space Marines or Orks.
6. Corsair Eldar: will never ally with Chaos, Space Marines or Orks.
7. Space Marines: will only ally with Imperials (including Adeptus Mechanicus) and Rogue Trader vessels (excluding Xenos ships). A Crusade fleet list will not ally with any fleet.
8. Rogue Traders: may ally with any fleet except Tyranids and Necrons but may not take Xenos vessels when allied with Space Marines.
9. Orks: will only ally with Chaos, Dark Eldar and Rogue Traders.
10. Demiurg and/or Kroot: will never ally with Orks or Space Marines. Even when allied with two fleets that are fighting each other, Demiurg and Kroot ships will never fire upon each other.
11. Necrons do not ally with any fleet.
12. Tyranids do not ally with any fleet.

FREQUENTLY ASKED QUESTIONS, ERRATA AND RULE ADDITIONS

IMPERIAL. SPACE MARINES AND ADEPTUS MECHANICUS FLEETS

IMPERIAL NAVY

The Imperial Power Ram may be taken by any Imperial capital ship with a 6+ prow for +5 points unless it has a Nova Cannon. This is for any Imperial fleet list and does not count as a separate refit. Ships so equipped impart one automatic hit during a successful ram on a target vessel before rolling for hits inflicted.

For every reference in the Rulebook and Armada, the correct price for an Emperor battleship is 365 points, an Apocalypse battleship is 365 points a Retribution Battleship is 345 points, and an Oberon battleship is 335 points.

In the Rulebook on p.108, a Mars battlecruiser may purchase a third turret for an additional +10 points.

In the Rulebook on p.114, the “Widowmakers” refit can only be taken by Cobra escorts, it can only be taken by escort squadrons where more than half the escorts are Cobras, and all the Cobras in the squadron must take the refit. Only Imperial escort squadrons may take this refit, not pirates, Chaos renegades, etc.

For every reference in the Rulebook and Armada, the correct price for an Overlord battlecruiser is 220 points. In the Rulebook on p.109, it is based on the Acheron heavy cruiser design and relies on systems derived from it for its targeting systems. For +15 points, its weapon batteries get a left-column shift on the gunnery table.

The Apocalypse Class battleship’s special rule on p.12 of Armada when it undertakes Lock-On special orders and fires its lances greater than 30cm does not take effect unless firing greater than 45cm, though the normal range of the lances is still 30cm. Additionally, it does not take 1Hp damage for the Thrusters Damaged, even though the critical damage still affects the ship, is cumulative and must be repaired normally. Except for this special rule, all critical damage (including Thrusters Damaged) taken in any manner affects this ship as it would be taken by any other ship normally.

Imperial grand cruisers count as battlecruisers in any fleet list they are used (even as reserves), meaning two cruisers are required for every grand cruiser in the fleet, and the Imperial fleet may have one grand cruiser or one battlecruiser for every two cruisers in the fleet, not one and the other. Additionally, grand cruisers do not count as cruisers for purposes of fielding battleships in any Imperial fleet list they are taken.

All Imperial Vengeance grand cruiser variants listed in Armada on pp.14-16 completely ignore prow critical damage, regardless of the cause. If any critical damage rolled against the table results in a Prow Armament Damaged critical hit, it is assumed the critical damage did not take place, and it does not move up to the next higher critical damage. If the critical damage is caused by the ship taking a hit, the hit itself still counts normally.

An Imperial Exorcist grand cruiser on p.16 of Armada may be equipped with Shark assault boats for an additional +10 points.

For every reference in the Rulebook and Armada, the correct price for an Armageddon battlecruiser is 235 points. In Armada on p.17, it may replace its prow torpedoes for a Nova Cannon for +20 points.

For every reference in the Rulebook and Armada, the correct price for the Endeavor and Endurance light cruisers are 110 points each. The Defiant light cruiser is 120 points.

The Endeavor, Endurance and Defiant light cruisers on pp.18-19 of Armada may increase their prow armor to 6+ for no additional cost. However, if this option is taken, the turning radius of these vessels is reduced to 45 degrees.

The fleet restrictions for Endurance and Defiant light cruisers on p.27 of Armada are entirely replaced by the following: no more than two of these vessels may be taken for every 500 points (or portion thereof) in the fleet. This is no more than two in total, meaning not two each of the Endurance and the Defiant.

ADEPTUS MECHANICUS

Adeptus Mechanicus vessels may always be taken as reserves by an Imperial Navy fleet, regardless of what fleet list is being used or whether or not they are



using allies.

Adeptus Mechanicus vessels may ignore the rule preventing them from firing upon or boarding friendly drifting/blazing hulks (see p.12 concerning shooting at hulked vessels). They will do this in an attempt to deny victory points to the enemy or induce catastrophic damage, to prevent their technology from falling into xenos or heretic hands. This rule only applies to Mechanicus vessels shooting at Mechanicus drifting hulks, and not Imperial Navy, reserve or allied vessels in the fleet. In order to do so, it must actually be a ship using rules from the Adeptus Mechanicus fleet list, not a Mechanicus model painted to be part of a standard or reserve Imperial fleet. Mechanicus vessels may shoot at enemy drifting/blazing hulks normally.

On the Adeptus Mechanicus fleet list, Endeavor and Endurance light cruisers cost 125 points, and the Defiant light cruiser costs 130 points. They can upgrade their prow armor to 6+ at no cost. However, if this option is taken, their turning radius is reduced to 45 degrees.



Adeptus Mechanicus Refits: When a 6 is rolled on the leadership table you may pick your refit instead rolling for it randomly; you don't get an extra one.

No more than two Mechanicus Gifts can ever be taken by a ship. If a ship that rolled a 6 when determining leadership subsequently has an Archmagos embarked, it does not get a third Gift! However, the rule concerning Gifts still applies; if the second rolled refit is identical to the refit already selected, the second refit may be chosen as well.

An Archmagos can be placed on any capital ship in the fleet desired unless an Ark Mechanicus is present, in which case it must be used as the flagship. The Ark Mechanicus *Omnissiah's Victory* cannot have any other Mechanicus Gifts besides those already in its special rules.

The Archmagos' ship only has two Mechanicus refits, though it may still earn standard Imperial fleet refits normally over the course of a campaign, as can any other Adeptus Mechanicus vessels.

Unlike their capital ships, Mechanicus escorts do not have the +1 turret as part of their point cost and do not get this refit automatically.

Adeptus Mechanicus versions of Imperial Navy vessels that have access to assault boats (such as the Emperor) may not use assault boats.

ADEPTUS ASTARTES

Any vessel that earns or pays for a refit to carry Thunderhawks may then ONLY carry them, and its launch bay capacity is reduced by half (rounding up when applicable). This also applies for those earned when rolling a 7 against the Space Marines table on p.157 of the rulebook. All normal rules concerning their use is unchanged from that on p.21 of Armada. Escort carriers may never be upgraded to carry Thunderhawks!

The profiles in Armada for Space Marine Strike Cruisers listed on p.23 and Gladius frigates on p.25 replaces any previously published profile of this vessel.

Space Marine battle barges as listed on p.24 may not use Come To New Heading special orders, regardless of any normal refits they may be equipped with.

In a campaign, the Space Marine fleet has access to the same refits and crew skills as Imperial and Chaos fleets on pp.156-157 of the rulebook. Space Marines may roll appeals against the Space Marines table on p.157 if desired. Ships earned as a result of rolling against this table are considered to be "for free" and do not count against fleet restrictions. For example, a fleet 1,500-point Space Marine fleet with two battlebarges that rolls a 2D6 roll of 2 against this table may waive the point restrictions and gain a third battlebarge, provided the owning player actually has three battlebarge models to represent it. Ships not able to take a particular refit rolled randomly may re-roll the result.

Space Marine vessels with Terminator boarding parties may use them every turn instead of once per game for no change in point cost.

RAMILIES STAR FORT

While Ramilies Star Forts are defenses, they are not restricted to the same leadership restrictions of other defences and can take on all shooting-based special orders normally.

The various quadrants of a Ramilies Star Fort automatically count as massing turrets (unless crippled or destroyed, following all normal rules for massing turrets discussed previously). However, only the quadrants adjacent to it can mass turrets with a given quadrant, giving it a maximum of +2 turrets. This is in addition to any ships that may be in base contact, though the maximum restriction of no more than +3 turrets still applies.

Although the four quadrants are essentially in contact with each other, blast markers are only placed between the quadrant taking fire and the quadrant closest in the line of fire to that taking fire. In other words, a single round of shooting from a ship or squadron cannot place blast markers in base contact with more than one other quadrant besides the

quadrant it is shooting at (for two in total) Quadrants not so affected count as not having blast markers in base contact, even if blast markers are in base contact with the model itself. *See p.4 about blast markers.*

When ramming the Ramilies you can only ram the quadrant you first contact on a line of sight from the ramming ship's movement. If a ship happens to make contact right at the junction between two quadrants (as measured by the model's base, not the model itself!), the ramming player may pick which one of the two adjacent quadrants in contact he or she wishes to ram.

As running out on doubles no longer applies to reloading ordnance, a Ramilies Star Fort may have in play up to twice the attack craft markers as the number of launch bays it has remaining. Additionally, as a docked ship can no longer take advantage of the benefit the Ramilies provides it for running out of ordnance, it instead is considered to have automatically reloaded ordnance (no Command Check required) if it remained docked for two full turns and was not braced.

Before the game starts, the owning player can decide

if the Ramilies will rotate or not. Once the decision is made, it cannot be changed throughout the game. If it is decided that it will rotate, it does so for 45 degrees once per game turn (no more or less) at the beginning of the owning players movement phase. If it rotates, it will always rotate in the same direction. The Ramilies otherwise does not move in any way during the course of the game, it still counts as defenses, and this movement does not alter nor can it be altered by any command checks or special orders the Ramilies can make. If the owning player decides the Ramilies Star Fort will rotate, then it cannot have ships dock with it for the duration of the game. Blast markers not removed remain in place when the Ramilies rotates and affect whatever quadrant they are in contact with at the end of its movement.

A Ramilies can be affected by hit and run attacks, which take place normally. However, only a Space Hulk can attempt a boarding action on a Ramilies. If it does so, the remaining hit points of all four quadrants apply to the Ramilies' boarding value, but only the turret value of the quadrant actually being boarded is added to this value. Resulting hits and critical damage are only applied to the quadrant that was actually affected by the boarding action.

The Ramilies can always board any enemy ships in base contact in the end phase of its own turn, and it can decide how many quadrants are involved in the boarding action.

When a quadrant is destroyed its quarter of the flying base is treated as an asteroid field. This effect cannot damage the other quadrants and remains unchanged if the owning player elected that it rotate at the start of the game.

A Ramilies can earn ship and weapon refits (NOT engine refits- re-roll this result!) over the course of a campaign, and any refits earned apply to all quadrants.

A Ramilies can purchase special torpedoes on p.156-157 of Armada. However, if the Basilica takes critical damage while armed with torpedoes affected by critical damage (such as vortex torpedoes), BOTH critical damage effects from the table and from the torpedo special rules applies. Resulting additional hits from damage caused by the torpedoes can be distributed among the Ramilies quadrants as decided by the enemy player.



FREQUENTLY ASKED QUESTIONS, ERRATA AND RULE ADDITIONS HERETICUS FLEETS AND CHAOS SPACE MARINES

A Chaos Warmaster (as opposed to a Lord) must always be used as a fleet commander in any Chaos fleet list that requires the use of a fleet commander. Under no circumstance can a Chaos Lord be placed on the same ship as a Warmaster.

When fielding a Chaos 12th Black Crusade fleet in the rulebook limited to only three Chaos Lords in a campaign, a player may purchase a Chaos Lord for a reinforcing vessel, but only to replace one that was aboard a ship lost in battle. This is separate from an additional (fourth) Chaos Lord earned in an appeal against the table on p.158 of the rulebook.

Multiple Chaos Marks of Slaanesh: If a ship is in range of effect of multiple marks of Slaanesh, it is only affected once.

Multiple Marks of Chaos on a Single Capital Ship: It is not possible to have multiple Marks of Chaos on a single capital ship in the 13th Black Crusade fleet list. Note: The Chaos 12th Black Crusade Incursion Fleet list in the rulebook still allows the Warmaster to have multiple Marks of Chaos.

Chaos has a +1 boarding modifier. The Chaos Space Marine upgrade in Armada replaces this, providing them with a total +2 boarding modifier (before all other modifiers are applied normally).

Abaddon the Despoiler and Chaos Space Marines: If you buy the Chaos Space Marine upgrade for a ship commanded by Abaddon, it is further improved. This

option can only be used if Abaddon is utilizing the 13th Black Crusade fleet list in Armada, in which case all the rules on p.43 of Armada apply. His ship will have a total +3 boarding modifier (+1 for Abaddon and +2 for Chaos Space Marines) before any other modifiers are applied. Abaddon has access to Terminator Teleport Assaults and all other benefits of having Chaos Space Marines described on p.45 of Armada. The ship may take any one Mark of Chaos for the point cost indicated. If a Mark of Khorne is taken, this doubles again the double already provided by having Abaddon aboard the ship! (This is unique in that fleet commanders do not normally multiply crew skills/benefits.) Note: If a mark of Tzeentch is chosen, you will gain no benefit unless Abaddon is killed as his specific rules dictate you may only use one command re-roll per turn.

Ships that earn Forces of Chaos through appeals or other means may continue to use these unaffected, even if they are braced, crippled, etc., unless it applies to ordnance attacks.

CHAOS VESSELS

Chaos fleet requirements: As Battleships, Grand Cruisers and Heavy Cruisers all have their own requirements you may use the same cruisers for these requirements. For example, a Chaos fleet can have a fleet comprised only of two Cruisers, one Heavy Cruiser (requires 2 Cruisers), one Grand Cruiser (requires three Cruisers or Heavy Cruisers) and a

Battleship (requires three Cruisers or Heavy Cruisers).

Warp Cannon on an Activated Blackstone Fortress or any similar weapon mechanic that ignores shields or behave as such also ignore holofields and any other similar mechanisms, such as reactive armor saves, spores, etc. Warp Cannon do not ignore any brace saves or any reactive armor modifiers while braced!

THE PLANET KILLER: The Armageddon Gun is a line of sight weapon and cannot fire through obstacles or celestial phenomena that act as normal line of sight obstructions, such as planets, moons, asteroid fields, etc.; a swirling jumble of million-ton rocks will disrupt even the awesome power of this weapon. However, place D6 blast markers at the point the Armageddon Gun template contacted the asteroid field, moon, etc. for the vaporized rock left in its wake. When used in Exterminatus, it does not face the normal restrictions for such weapons. Once in low orbit, it can fire up to 60cm and does not need to roll a 4+ to hit.

The Armageddon Gun overcharge “planet killer” shot works as follows: the ship must declare it is charging over three consecutive turns. No leadership check is required, but the ship may not turn, shoot or go on any special orders, including Brace For Impact. Once started, the process cannot be stopped, during which time the ship gains +2 shields. After the movement phase of the third turn, the ship immediately fires by moving the Nova Cannon template directly in front of



the vessel 60cm (not 90cm). If any part of the template touches any ship's base, that ship is completely destroyed, no saves allowed. The first planet or moon touched by the center hole is removed on a 2+ in D3 turns and replaced by a 2D6 by 2D6 asteroid field. This shot can fire through asteroid fields but will not remove them by doing so. After firing this shot, the Planet Killer must pass a reload ordnance special order for two turns to bring the Armageddon Gun back online, during which time it may not fire any weapons at all but moves normally.

All restrictions for battleships apply to the Planet Killer. In other words, you need to field at least 1,000 points of ships AND meet fleet list requirements to field it as a battleship in the fleet.

GRAND CRUISERS: All Chaos Vengeance grand cruiser variants listed in Armada on pp.38-39 completely ignore prow critical damage, regardless of the cause. If any critical damage rolled against the table results in a Prow Armament Damaged critical hit, it is assumed the critical damage did not take place, and it does not move up to the next higher critical damage. If the critical damage is caused by the ship taking a hit, the hit itself still counts normally.

The Chaos Repulsive Grand Cruiser can be modelled on a large base. If so mounted, it may have a third shield for +15pts. It must be modelled on a large base to have this this refit available for the cost indicated. This is not a normal refit and can be used in one-off games or in addition to any other refits earned normally in the course of a campaign.

SHIP POINT COSTS: For every reference in the Rulebook and Armada, the correct price for a Retaliator grand cruiser is 260 points.

For every reference in the Rulebook and Armada, the correct price for a Styx heavy cruiser is 260 points.

Chaos Murder Class Cruiser Variant: The Murder variant described in the notes on p.123 of the rulebook has broadsides consisting of four weapons batteries and two lances, all at 45cm range. These are broadsides and so have port and starboard arcs. This

variant is more uncommon than the standard Murder; no more than two of this variant may be used per 750 points (or any part thereof) in a Chaos fleet, meaning a fleet greater than 750 points may have up to four.

The profile for the Devastation on p.123 of the rulebook lists different names for the types of attack craft used. This does not affect how they are used in any respect, and they are in all respects the same.

RENEGADE IMPERIAL VESSELS: The Imperial Navy has taken great pains after the 12th Black Crusade to ensure that its warships do not fall into the foul hands of Chaos. While only the most seasoned and august of ship captains command the Emperor's battleships and battlecruisers, this is not always the case for its escorts and second-line warships. For every 1,500 points in a Chaos fleet, one cruiser from any Imperial Navy fleet list up to 185 points and/or up to six Imperial Navy escorts may be taken. Special weapon rules, Nova Cannon, Chaos Lords, Chaos Space Marines, Chaos ordnance or Daemonship upgrades may not be taken for Imperial Navy vessels used in this manner, and cruisers suffer -1Ld for going renegade. Imperial Navy escorts need not be in a single squadron and may be interspersed within other Chaos escort squadrons if desired. These vessels do not count as reserves; they count as Chaos vessels in all respects.

CHAOS DAEMONSHIPS

A Daemonship cannot be forced to disengage by a scatter roll that places it off the table. If a Daemonship scatters off the table when deploying, place the Daemonship so that its base is completely on the table on the point of the table edge indicated by the scatter dice, facing any direction desired by the Chaos player.

Daemonships cannot be used in squadrons.

When a Daemon ship is still spectral and has not fully materialized into normal space, it cannot move, shoot, board or conduct any action in any way, though any Marks it may have still take effect

immediately. It also may not be shot at, boarded, rammed or have any action done to it while spectral.

If a Daemon ship fully materializes in contact with celestial phenomena, it suffers any effects of those celestial phenomena, such as gas clouds, asteroid fields, etc. before the start of its movement phase. However, if it materializes in an asteroid field, it may then attempt to avoid damage by making a leadership check normally.

DAEMONSHIP HAUNTING: When a Daemonship is 'haunting' or is spectral it can still suffer damage from fire critical hits. In addition to repairing damage, they may repair critical hits while in the warp rolling normally, repairing critical damage on a 4+ as opposed to a 6. However, Daemonships may not make repair rolls in the end phase they are first deployed when returning into play.

If Daemonships repair enough hits while "haunting" to no longer be crippled, they will still count as disengaged for purposes of victory points but will no longer count as crippled.

Daemonships do not automatically regain hits after each battle. They have to be regained either in a game by warp translation or by expending repair points, or they can be withdrawn normally.



FREQUENTLY ASKED QUESTIONS, ERRATA AND RULE ADDITIONS CORSAIR ELDAR. CRAFTWORLD ELDAR AND DARK ELDAR FLEETS



Movement and Solar Sail Arcs: An easy way to determine a ship's facing in relation to the sunward edge is to place a bearing compass over the ship and draw the shortest possible line from the ship's stem to the sunward edge. The arc this line passes through is the sunward facing, or sunward arc.

Corsair and Craftworld Eldar ships cannot take All Ahead Full orders and thus cannot ram. Theme-wise, these Eldar ships would generally not resort to this kind of tactic anyway. Dark Eldar ships however can take All Ahead Full special orders and are thus not prohibited from ramming.

If under Lock-On special orders, Eldar ships cannot turn for BOTH their movement phases. When locked-on, Eldar Pulsars re-roll EACH miss until either up to three hits is scored or a miss is missed again.

Dark Eldar minimum movement: Like all other Eldar ships, Dark Eldar vessels do not have a minimum movement requirement. Note: All Eldar ships still fall under the restriction that if a ship moves less than 5cm it counts as a defence for shooting purposes. However, Holofields still work normally.

Eldar and Dark Eldar ships can make a leadership check to ignore all effects of celestial phenomena such as gas clouds, solar flares, etc. Escorts may re-roll this result for free. If an Eldar vessel passes its leadership check during a solar flare, it will take no damage but turn directly away from the sun edge and move 2D6cm. This ability only applies to celestial phenomena, not explosions

from catastrophic damage, nova cannon, etc. It also does not affect negative leadership modifiers caused by radiation bursts. Leadership checks against asteroid fields are unchanged from those for other fleets.

When shooting, all Eldar weapon batteries always count as closing before any modifiers. However, they still count as shooting as defenses when doing so.

Eldar and Dark Eldar must determine if they wish to brace against damage they may face BEFORE rolling their holofield save. This includes damage from scatter weapons such as Nova Cannon fire.

An Eldar vessel intending to board an opponent may do so in either movement phase, but it may not shoot or launch ordnance before doing so. If it boards in its movement phase, it may not make its second movement.

HOLOFIELDS

Holofields and Shadowfields work essentially the same way in all respects. They save against ALL strength-based weapons, Nova Cannon shots, any ordnance attacks and any kind of hit and run attacks, ramming and boarding. Against ramming and boarding, they save once against the ramming or boarding attempt, NOT against any damage suffered if this save fails. They do NOT protect against hits caused by celestial phenomena nor any area effects such as Warp Drive implosions, Necron Nightmare Fields, Chaos Marks of Slaanesh, etc. *See p.5 for how Nova Cannon are affected by holofields.*

When protecting against damage (except against weapons that use the gunnery table), Holofields roll its save once against each successful attack, whether it be from lance fire, ordnance hits, etc. In other words, its rolls once against a ramming attack, once against each Nova Cannon shot, and once against each hit imparted by ordnance attacks, Hit and Run attacks, etc.

Against firepower-based weapons such as weapon batteries, holofields only provide a right-shift modifier to hit unless specifically indicated otherwise, and it does not modify rolls to hit beyond the far right end of the table.

Corsair Void Stalker point restrictions: In a Corsair fleet list you may only have a Void Stalker in your fleet if your fleet list is worth 1000 points or more. This limit is very strict; if you are playing a 1000pt game and your fleet list is 995pts or less you cannot field a Void Stalker.

For every reference in the Rulebook and Armada, the correct price for the Hellebore frigate is 65 points and the Aconite frigate is 55 points.

ELDAR ORDNANCE

All Eldar Ordnance (including Dark Eldar) can only be hit by turrets n a 6. This includes Vampires, any torpedo types, assault boats and orbital mines.

When Eldar orbital mines are used, they completely replace all other attack craft used by the launching carrier, with one orbital mine per launch bay.

As Eldar vessels do not actually have turrets, enemy bombers do not get any bonus against turrets from escorting fighters.

CRAFTWORLD ELDAR

The Eldar Hero costs 100 points, not 150 points.

You require a Hero to field the Flame of Asuryan. The Flame of Asuryan counts as a Dragonship in the Craftworld Fleet List and a cruiser in the Corsair Fleet List. This is a unique ship; only one is allowed in the fleet list, regardless of the size of the fleet.

The port and starboard pulsar lances of the Flame of Asuryan are considered Keel weapons for purposes of critical damage. They share a single weapon position and so will be affected when weapons strength is halved for whatever reason. The launch bays carry Vampire Raiders at no extra cost. The keel pulsar lance fire arcs are left/front and right/front respectively.

The strength of the Dragonship's weapons battery option is 14, the torpedo option is 8 and the launch bay option is 4.

The profile concerning Craftworld Eldar escorts remain unchanged but replace their special rules with the following: Shadowhunters are so nimble that they can even pursue attack craft with ease, harrying the smaller vessels with an agility impossible for other escorts. When coming in base contact with any enemy ordnance, they may re-roll a failed holofield save (the second roll stands). This effect only works against attack craft, and markers that behave only as fighters are still ignored normally. The rules for the Craftworld Eldar Phantom Lance remain unchanged. Due to their extremely small size, Craftworld Eldar escorts cannot initiate boarding actions. A ship that successfully boards a Craftworld Eldar escort gains a +1 modifier in addition to any other modifiers.

Eldar Ghostships may move normally if they fail a special order, but they may not shoot, launch ordnance, etc.

Corsair Eldar and Craftworld Eldar fleet lists count as reserves of each other, following all normal rules, but to do so an Eldar Hero must lead the fleet as described in the Craftworld Eldar rules.

DARK ELDAR

The Dark Eldar Torture cruiser on p.56 of Armada has an unmodified value of 210 points, not 130 points. In the Armada fleet list, prow torpedoes are an optional weapon system it can be equipped with besides its weapon batteries as opposed to a weapon that must be replaced.

Dark Eldar cruisers may if desired be equipped with two Impaler assault modules instead of one. Their individual cost remains unchanged; it costs +20 points for each Impaler taken by a Dark Eldar cruiser.

The Dark Eldar mimic engine described on p.54 of Armada is unchanged, but its ability to not be targeted by enemy ships in the first turn is lost if ordnance it launches in the first turn attacks enemy ordnance or ships. If its ordnance does not attack during the first turn, enemy ordnance must assume it is friendly and cannot attack it, though enemy ships

that move in base contact with it in the first turn will still be attacked normally. Mimic Engines cost +20 points for cruisers and +5 points per escort.

Dark Eldar ordnance and attack craft enjoys all resilience and re-roll benefits Eldar ordnance does, and they behave in the same manner in all respects.

Leech Torpedoes: in addition to all the rules for this weapon on p.55 of Armada, Leech torpedoes take effect immediately (being braced can save normally against this), do not roll against armor and do not automatically destroy escorts. Leech torpedoes otherwise behave as Eldar torpedoes in all respects and are only hit by turrets on rolls of 6. Escorts can also repair this effect with a roll of 6 in the same manner capital ships repair critical damage.

Dark Eldar receive a +1 to any of their Hit & Run attacks, including those from Slavebringer assault boats but excluding Impaler Assault Modules.

Slavetaking may be performed instead of any Hit & Run, including teleporter and Impaler attacks. When using Impalers for slavetaking, they forgo their normal 2D6 roll and instead collect +30 victory points vice +10 points. Brace saves may be taken against Slavetaking. Slavetaking cannot be conducted against Necron or Tyranid fleets. Any escort-sized ship is in addition considered destroyed if 30 or more victory points are collected from it by slavetaking.

In a campaign, a Dark Eldar or Craftworld Eldar fleet commander earns promotions (re-rolls) in the same manner as the Eldar as listed on p.153 of the rulebook.

ELDAR TRANSPORTS

Corsair and Craftworld Eldar fleets can use transports in scenarios that call for transports where the Eldar are playing the defender. The Eldar transport moves 10/10/15cm, and it is equipped with one 15cm weapon battery (front). It otherwise follows all movement, shooting and holofield rules for Eldar ships. Dark Eldar fleets do not have access to this transport. However, they may use Imperial transports (of all types) to represent captured and looted merchant ships they are returning to their lair.

FREQUENTLY ASKED QUESTIONS, ERRATA AND RULE ADDITIONS

ORK PIRATE AND WAAGH! FLEETS

The All Ahead Full special order can be taken by Orks for free. However, this does not exempt it from the restrictions that occur when a ship or squadron fails a special order command check. If an Ork command check is failed Ork ships not already on All Ahead Full may not then be put on All Ahead Full special orders.

Dakka Dakka: Ork capital ships can add +2 turrets to their ships for +20 points (this is not the same thing as saying “up to two turrets at +10 points each”). Ork escorts may add +1 turret for +5 points per escort unless a particular fleet lists adjusts this. If this option is taken, every escort in a given squadron must take the refit, not just individual escorts in a squadron.

ORK ORDNANCE

Any capital ship in the Ork fleet list armed with torpedoes can use boarding torpedoes for +5 points, regardless of whether or not it appears in the notes for that vessel. A Space Hulk may use boarding torpedoes for +15 points. Escorts cannot use boarding torpedoes.

Fighta-Bommas are fighters with a speed of 25cm. They may also attack like bombers with D3 attack

runs instead of D6.

TURRET SUPPRESSION: Ork fighta-Bommas and other attack craft that behave as both bombers and fighters apply this bonus by adding +1 attack for each marker in the wave after attacks are modified by turrets, meaning each ordnance marker that survives against turrets will be able to conduct at least one attack and will not have a minimum of zero attacks.

When a wave of fighta-bommas attacks a ship you must decide beforehand if any of the markers will forgo their attack runs in favour of turret suppression. Every one that does so cannot make any attack rolls but adds an additional +1 bonus attack to any surviving fighta-bommas when rolling their attacks. Fighta-bommas used in this manner cannot contribute more bonus attacks than the defending ship actually has turrets or the number of surviving fighta-bomma markers, whichever number is lower. See the following examples for how this affects the outcome:

1. A Terror Ship launches a single wave of four fighta-bommas against a Devastation cruiser with three turrets and no CAP. The Devastation’s turrets roll 2,3,4 to knock down one fighta-bomma. The three surviving markers now *each* roll 1D3-3 (minimum zero) attacks,

but because each marker also counts as a fighter, it adds +1 attack for each marker, for a *single* total addition of +3 attacks.

2. A Terror Ship launches a single wave of four fighta-bommas against a Devastation cruiser with three turrets and no CAP, declaring two markers are not attacking and will only be suppressing turrets. The Devastation’s turrets roll 2,3,4 to knock down one fighta-bomma. Another one of the surviving markers is removed for suppressing turrets. The two remaining markers now *each* roll 1D3-3 (minimum zero) attacks, but because each marker also counts as a fighter, it adds +1 attack for each marker. It then adds +2 attacks for the two markers used only to suppress turrets (even though one was removed), for a *single* total addition of +4 attacks.

NOTE: In either case, at least one fighta-bomma has to survive against turrets for the wave to attack in this manner.

Torpedo Bommas do NOT retain the ability to behave as fighters and cannot intercept other ordnance or provide a bonus attack for turret suppression. In addition, their speed is reduced to 20cm. Torpedo Bommas always cost +10 points per launch bay based on the MAXIMUM launch bay strength of a given vessel. This means a Terror Ship must pay +40 points and a Space Hulk must pay +160 points to use Torpedo Bommas.

Ork Orbital Mines: Orks may buy orbital mines like other fleets at +5pts per bay and minefields for the normal point cost. In the case of the Hammer class battlekroozer this costs 20pts. Note: Ork Space Hulks cannot take orbital mines. Regardless of how the Orks refer to the four named Ork battleships, they are battleships nonetheless and cannot take orbital mines.

In Armada, the special rules for the *Deathdeala* battleship on p.64, the *Slamblasta* battleship on p.66, the *Kroolboy* battleship on p.67 and the Hammer



battle kroozer on p.68 should list torpedo Bommas as worth +40 points. For the *Gorbag's Revenge* battleship on p.65 of Armada, Torpedo Bommas are +80 points.

ORK SPACE HULK

Space Hulks can use All Ahead Full special orders but cannot gain extra movement by doing so. This will allow them to attempt to ram, but given the size and poor leadership of a Space Hulk, it will only be viable against defences. Because it is a Defense, it must roll leadership against 3D6 to ram anything besides another defense, against which it rolls 2D6.

Space Hulks do not have a low orbit table! They're stem sized after all.

The Space Hulk critical damage table on p.62 of Armada is replaced by the following:

ORK SPACE HULK CRITICAL DAMAGE TABLE

When receiving critical damage, roll a D6 against the following table:

1-2: Target high energy systems! Roll a D6:

- 1-2: -1 dorsal lance
- 3-4: -1 shield
- 5-6: -1 turret strength

3-4: Target weapons clusters! Roll a D6, affecting only the quadrant the attack originated from:

- 1-2: -1 launch bay (except prow/aft)
- 3-4: -1 torpedo strength (except aft)
- 5-6: -2 weapon battery firepower

5-6: Target thruster assemblies! The Space Hulk must roll higher on a D6 than the number of thruster damage criticals it has suffered in order to turn.

Damage rolled that does not apply for any reason immediately assumes the next higher level damage on the table. Space Hulks cannot repair any critical damage in the course of a battle.

ORK PLANETARY DEFENSES

Ork Roks can be taken as planetary defenses and purchased using planetary defense point allowances in scenarios that allow the use of planetary defenses and the Orks are the defender. When used in this manner, they follow all rules for planetary defenses, meaning they automatically pass all leadership checks they are required to make but cannot undergo any Special Orders except Reload Ordnance and Brace For Impact, for which they are Leadership 7 (Yes, 7 and not 6!). Ork Roks cannot move and count as stationary in all effects when purchased as defenses, including all rules concerning removal of blast markers from planetary defenses. When used in this manner, roll a 2D6 after setting up each Rok. On a roll of 12, the Rok falls 2D6cm toward the celestial phenomena it is orbiting near. If the Rok makes contact with an asteroid field or the planet edge in this manner, it is destroyed!

When playing the defender in scenarios that call for planetary defenses, Orks have access to all the defenses listed on pp.141-146 in the rulebook. These can be represented as captured Imperial or Chaos defenses, or weapon emplacements installed on small asteroids. System ships, defense monitors and fireships can all be captured vessels, worn out Brute ramships or gunships that have more dakka bolted on to defend 'da planet! In place of the Imperial Blackstone Fortress, substitute a non-moving Space Hulk using the same (unchanged) profile and point cost listed on p.145.

ORK ESCORTS

For every reference in the Rulebook and Armada, the correct price for an Onslaught Attack Ship is 35 points. The firepower of its Gunz battery is D6, not D6+1.

For every reference in the Rulebook and Armada, the correct price for a Savage Gunship is 30 points. Its speed is 25cm, not 20cm.

For every reference in the Rulebook and Armada, the correct price for a Ravager Attack Ship is 40 points. Its turret value is 2, not 1.

All Ork fleets have access to the Grunt assault ship. By definition, this escort has the same profile as the Ork Brute with the following changes: 30 points, Armor 6+ Prow/5+, 2 turrets. Special rule: The Ork Grunt is constructed primarily to act as a huge armored assault ship. Even though it is in every respect an escort with only 1Hp, it has a boarding strength of two when attempting to board or being boarded, as if it were a 2Hp vessel. Likewise when attempting to ram, it uses 2D6 when rolling to hit, as opposed to 4D6 like Brute ramships or 1D6 like other escorts. Grunts are equipped with Tractor fields and are mounted on a large base. They are ponderous for their size due to the Tractor Field and cannot use Come To new Heading special orders. Grunts may be easily represented by mounting Brute models on a large (battleship) base. Only by basing these models on a large base may they use the Grunt profile and point cost.



FREQUENTLY ASKED QUESTIONS, ERRATA AND RULE ADDITIONS

NECRON REAPER FLEETS

ALL AHEAD FULL SPECIAL ORDERS

Inertialess drives merely replace the bonus distance travelled. All rules concerning All Ahead Full still apply so weapon strengths are still halved.

REACTIVE HULL

Necrons do not get a 4+ brace save, as the Reactive Hull save replaces it and for all intents and purposes is treated in the same manner as a brace save. This includes when the reactive hull save is modified to 2+ when Necron vessels are actually under Brace For Impact special orders. It does not save against hit and

run attacks unless the ship is actually braced.

Warp cannons ignore reactive hull saves unless the Necron ship is braced. *See p.21 concerning the Warp Cannon.*

NECRON WEAPONS

Particle Whips ignore shields, holofields or any other mechanism that performs a similar function (such as Tyranid spores) on a to-hit roll of 6. Otherwise they behave as normal lances.

Star Pulse Generators and Nightmare field may not fire if on special orders according to p.73 of Armada. This applies to Lock-On special orders as well.

The Star Pulse Generator rolls 1D6 to hit against the nearest facing armor value separately against every ship in range. This is an area effect that cannot be saved against by holofields or anything similar. It rolls 4+ against every separate ordnance marker in range (as opposed to against ordnance waves).

Necron Portals are a unique system that work in addition to normal teleport attacks and are not restricted by a ship being on ANY special orders (including Brace For Impact), except that they are still cut in half (rounding down) if a ship is crippled or Braced. A Necron capital ship both crippled and Braced may not make Portal attacks.

Necron vessels may ignore the rule preventing them from firing upon or boarding friendly drifting/blazing hulks (*see p.12 concerning shooting at hulked vessels*). They will do this in an attempt to deny victory points to the enemy or induce catastrophic damage, to prevent their technology from falling into the hands of other races. This rule only applies to Necron vessels shooting at Necron drifting hulks. Necron vessels may shoot at enemy drifting/blazing hulks normally.

Necron victory point values on p.74 of Armada replace any other published list of these values.

Necrons do not have access to any refits or crew skills in the course of a campaign, but the fleet as a whole may earn additional repair points in the same manner other fleet's ships earn refits or crew skills.

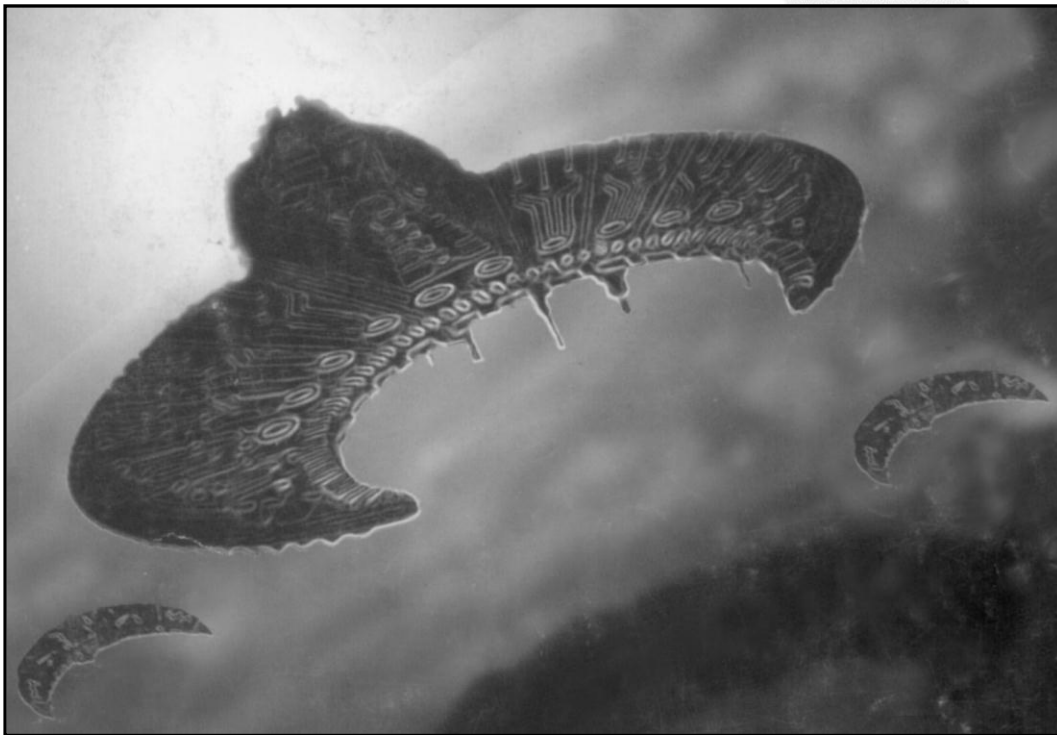

FREQUENTLY ASKED QUESTIONS, ERRATA AND RULE ADDITIONS

TYRANID VANGUARD AND HIVE FLEETS

In a Vanguard Fleet, you may test to override instinctive behaviour for all your squadrons even if a squadron fails. All the other rules for Vanguard fleets listed on p.82 and p.90 of Armada still apply.

You may test for synaptic control over a ship which failed the test the same turn, including other Hiveships, as long as there is another Hiveship within range.

If a ship goes All Ahead Full under synaptic control (by leadership test) instead of instinctive behaviour, it may move an additional +4D6cm instead of +2D6cm. Having the Adrenaline Sacs refit adds +1D6 in either case.

Where the number of spore cysts is written as a turret strength in a ship's profile, they also count as the shield strength as noted in their special rules.

Spore impacts from moving in base contact with Tyranid vessels effect enemy ship movement, meaning enemy vessels lose -5cm speed and ships with zero shields (such as Eldar and ships with Shields Collapsed critical damage) have to roll a D6 against receiving damage on a 6. However, this test (if required) only needs to be done once per movement phase, regardless of how many Tyranid ships make base contact. The ship only counts as having blast markers in base contact if it ends its



movement in base contact with a Tyranid vessel.

Tyranid spores act as both shields and turrets. Each blast marker in contact reduces the "turret to-hit roll" of one spore from 4+ to 6+. If a spore is already rolling against ordnance that requires 6+ to hit (such as against Eldar), being in contact with blast markers has no additional effect.

The number of spores a ship has is subtracted from a bomber's die roll to determine number of attacks made like a true turret value. Blast markers in contact have no effect on this.

Any ship attempting to fire upon a hiveship suffers -1ld when attempting to ignore closer targets if a squadron containing only escort drones is in base contact with as well as in between the hiveship and the firing vessel.

TYRANID WEAPONS

Tyranid hiveships do not get "free" bio-plasma; their cost is exactly as listed in the profile on p.87 of Armada. The broadside pyro-acid and bio-plasma profile categories are to be considered listed as "Left/Right." They are separate broadsides for the left and right sides of the vessel.

Tyranid cruisers on p.88 of Armada get fpr-8x30cm pyro-acid batteries firing left/front/right listed on their profile for +20 points.

Bio Plasma ignores shields in a similar fashion to that of ordnance, only they cannot be shot by turrets either! Bio Plasma does not ignore holofields or reactive hull saves.

Feeder Tentacles and Massive Claws may not attack a ship that made contact during the opponents turn. However, the Tyranid player can elect in its own turn to remain in contact so that feeder tentacles and massive claws can take effect normally. In other

words, in the Tyranid player's own movement phase, it may elect to immediately attack vessels in base contact with feeder tentacles and massive claws instead of moving normally in the same manner other ships may effect a boarding action. Keep in mind that a ship can still complete its move normally after a feeder tentacles attack, though each ship can only attack an enemy ship in this manner once per turn.

A Tyranid vessel with two sets of massive claws may use any two claws to perform its "grab" on an enemy vessel, rolling again to hit in every End Phase as described on p.84 of Armada.

If a ship is grabbed by massive claws it cannot attempt to disengage until free of them.

The sizes for the purposes of continuing movement while grabbed by Massive Claws are exactly the same as ramming, so from biggest to smallest: Defense > Battleship > Cruiser > Escort. For example, a battleship with a bunch of Tyranid escorts hanging on should be able to move (and be cool to see!). An Imperial escort latched by a Tyranid cruiser should pretty much behave like a speared fish!

TYRANID ESCORTS

The fleet must have at least six escort drones for every hiveship in the fleet. If desired, this may be in addition to the 6-12 escorts (of any type) that may be taken for every hiveship in the fleet.

As Tyranid Kraken do not have spores, they cannot evolve the ability to use spores and thus cannot take the additional spore cysts refit.

Tyranid Kraken on p.89 of Armada can select a strength-2, range 15cm bio-plasma discharge for +10 points on the fleet list on pp.90-91.

Up to 10% of the Tyranid escort drones in the fleet can elect to become fireships instead of taking a

weapon on p.90 of Armada for +5 points each. If used in this manner, it still utilizes all regular rules for escort drones concerning movement, spores, etc., and it may use the fire ship special rules detailed on p.143 of the main rulebook, even if the scenario does not call for the use of planetary defenses such as fireships.

TYRANID ORDNANCE

Tyrannid ordnance is exempted from attack craft limits based on number of launch bays and cannot run out of ordnance. They may have up to twice the number of attack craft markers in play as they have available launch bays.

Tyrannid attack craft consist only of fighters and assault boats. As they cannot have bombers, they obviously cannot have torpedo bombers.

Tyrannid hiveships have Strength-6 torpedo launchers as a front-firing prow weapon option for the price indicated on p.91 of Armada.

BOARDING ACTIONS

Tyrannids ignore ALL blast marker effects when boarding. They do however lose a measure of their spore protection for being in contact with blast markers due to placing one on the target vessel when boarding; place the blast marker at the point it and the Tyrannid vessel make contact. While they ignore all blast marker effects when boarding, the target vessel does not. As such, Tyrannids get a +1 for the enemy being in contact with blast markers.

The rule concerning “All is Lost” on p.83 in Armada refers to ships being boarded by Tyrannids. It does NOT refer to ships foolish enough to actually attempt boarding a Tyrannid ship! This prevents a doomed enemy cruiser from deliberately boarding a Tyrannid vessel then proclaiming All is Lost.

When conducting hit and run attacks of any type against Tyrannid escorts, roll 2D6 and take the lowest D6 for the roll, destroying the escort on a roll of 4+. See p.12 for more on Hit and Run attacks.

TYRANID REFITS

Tyrannids do not have access to any crew skills in the course of a campaign. They may gain refits in the course of a campaign as outlined by the rules on p. 92 of Armada. These refits can only be used in one-off games if both players agree.

Multiple Tyrannid Refits: A hiveship can have three ‘different’ refits and may therefore have four reinforced carapaces, two extra spore cysts and one other refit. A cruiser can have the three reinforced carapaces (as four would make it a Hiveship!) and two extra spore cysts. Keep in mind that if the fleet does not desire or by restrictions cannot have another

hiveship, then the fourth reinforced carapace refit cannot be taken by a Tyrannid cruiser.

Accelerated Healing refit: The two extra repair dice are added after the halving of the dice for having a Blast Marker in contact with a vessel.

SCENARIOS

For the Cruiser Clash scenario, Tyrannids can use one hiveship and three cruisers instead of the four cruisers described on p.93 of Armada. If this option is used, no refits or escorts can be taken, and the hiveship cannot be higher than Ld-8.



FREQUENTLY ASKED QUESTIONS, ERRATA AND RULE ADDITIONS TAU KOR'VATTRA AND KOR'OR'VESH FLEETS

The Bor'kan Explorer variant's gravitic launcher fire arc is front.

For every reference in the Rulebook and Armada, the correct price for a Merchant starship is 95 points.

Tracking systems are fully functional under any special order on any ship or defense equipped with them, including Brace For Impact.

Tau Orbitals follow all High Orbit and Satellite defence rules.

Tau Waystations and Nicassar Rigs are defences that may be deployed anywhere within the Tau deployment zone. In the case of an Orbit Lost critical hit the only effect is the loss of a hit point unless the waystation or Rig is within the gravity well of a planet or moon.

Nicassar Dhows can only be deployed from Nicassar Rigs, Explorer starships and Merchant starships equipped with grav hooks. Only a number of Nicassar dhows can be deployed equal to the number of grav hooks present at the start of the battle on the ship or defense types described here.

In a campaign, a Tau fleet commander earns promotions (re-rolls) in the same manner as Imperials. The Tau fleet has access to the same refits and crew skills as Imperial and Chaos fleets on pp.156-157 of the rulebook. Ships not able to take a

particular refit rolled randomly may re-roll the result.

When deployed from Rigs being used as planetary defenses, Nicassar Dhows have leadership 8 and the Rig has leadership 7. When allocated from a list as planetary defenses, they follow all rules and restrictions that apply for planetary defenses concerning leadership tests and special orders. This same rule applies to Tau Orcas deploying from Orbitals used as planetary defenses, except the Orca shares the leadership of its Orbital when used in this manner (Ld7).

The Kroot Warsphere's boarding strength is double its remaining hit points, not a flat strength of 20 listed on p.108 of Armada.

When the Demiurg are used as a pure or primary fleet (or when facing Orks), the point costs are unchanged, but the victory points earned by the enemy if destroyed or crippled are based on the special notes of pp.110-111 of Armada. When used in this manner, they will not attempt to disengage automatically until reduced to 2Hp or less.

A pure Demiurg fleet may include Kroot Warspheres following the requirements on p.112 of Armada. In a pure Demiurg fleet, up to one Stronghold commerce vessel may be taken for every two Bastion commerce vessels in the fleet, though there is no limit to the number of Bastions the fleet may contain. If desired, the fleet may have one squadron of up to six escorts

from any one of either the Imperial, Chaos or Tau fleet lists for every full 1,000 points of Demiurg ships in the fleet. A Pure Demiurg fleet used in this manner is not restricted to the rule forcing Demiurg ships to attempt to disengage when crippled.

At the start of the movement phase, Demiurg ships immediately remove any blast markers they are in contact with from a previous shooting phase, as printed on p.109 of Armada. When this happens, ships in base contact with the Demiurg vessel and sharing blast markers with them lose these (along with their effects) as well. Those blast markers are gathered up by the Demiurg ship and used like any other to charge its Cutting Beam. They subsequently are not slowed down by 5cm or face any other negative effects of moving through blast markers, though any leadership checks they were required to make before the movement phase are still affected normally by blast markers.

Any Demiurg ship may extend the range of its cutting beam by halving its effective strength, rounding down. For example, a Demiurg Bastion that gathers up four blast markers in the course of its last movement may in the shooting phase fire a str-5, range-15cm cutting beam or a str-2, range-30cm cutting beam. The cutting beam always starts with an effective strength of one before adding for blast markers, and it will never have less than this as long as it is operational.



BATTLEFLEET BAKKA

THE SAVIORS OF MACCRAGE DURING THE FIRST TYRANIC WAR

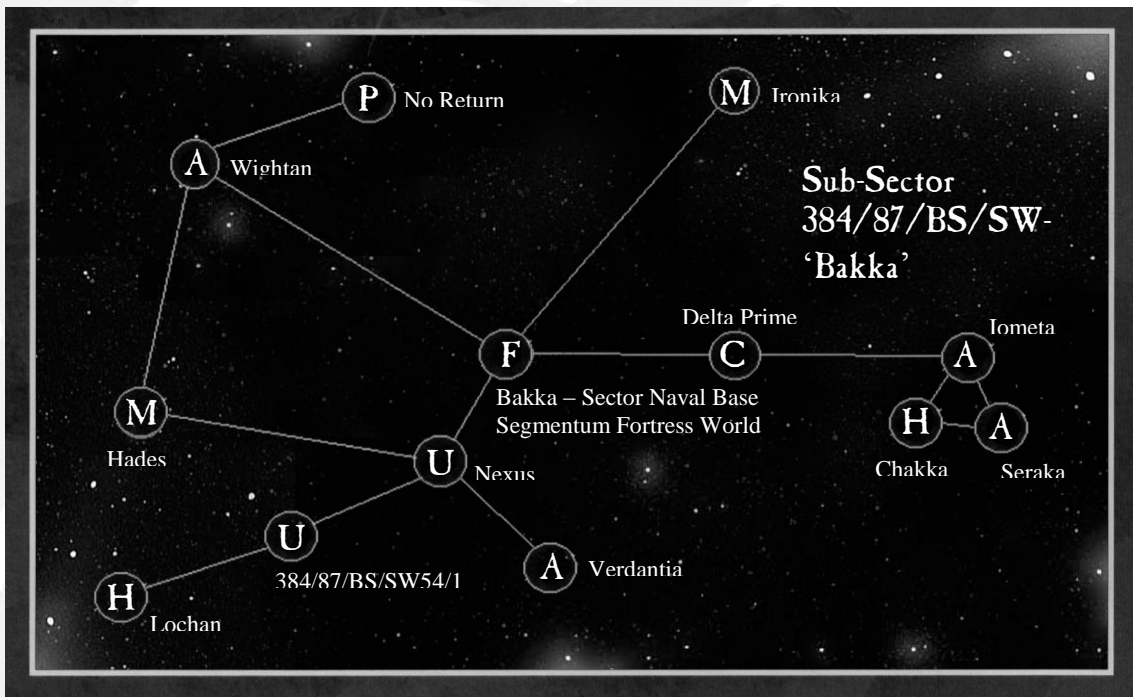

tacticians, sometimes called the Gareox Prerogative because they were based at the Gareox Sector Base, came to prominence. This 'Young School' proposed a complete change to Imperial Navy fleets based on attack-craft carriers as such tactics had proved highly effective against pirate squadrons. The arrogant Prerogative eventually gained enough political influence to control ship design and were able to order the construction of attack-carrier warships such as the ill-fated *Despoiler* class battleships. This action brought them into conflict with the 'Big-Gun Lobby' at Bakka. Political rivalry eventually led to outright civil war, the so-called Gareox incident (Inquisita Classificationae Purgata Secrata, level sextus).

A series of fleet actions demonstrated the superiority of lance-armed warships over attack carriers and the Prerogative was purged and Gareox cleansed. In their bitterness, many of their supporters in the Fleet turned to blasphemy and fled into the warp. Only three *Despoilers* were built out of the fifteen originally ordered and all became traitors. This incident left for many centuries a suspicion of attack carriers in Tempestus battlefleets, and even today there is a tendency for such fleets to favor big-gun ships. This is particularly true of Battlefleet Bakka where the Big-Gun Lobby had subsequently reigned supreme.

Put not your trust in ships because ships fall.
Put not your trust in guns because guns fall silent.
Put not your trust in men because men break.
Put your trust in the Emperor because he is the salvation of mankind.

• *Epistle to the Macraggans*

SEGMENTUM TEMPESTUS

Segmentum Tempestus is one of the five Segmentae Majoris, the great administrative divisions of the galaxy. It lies to the galactic south of Segmentum Solar, between Segmentum Pacificus to the galactic west and the Ultima Segmentum to the galactic east. Here, matter is scarce and the Segmentum is mostly a dark and empty void dimly lit by scattered stars. Like the other Segmentae Majoris, it is organized into 200 light-year cubes called sectors. The naval headquarters are located in a 15 light-year cuboid, Subsector Bakka, which is located on the main galactic star arm that passes through the east of the

Segmentum. It is mercifully free from proximity to a festering mass incursion from the warp, such as the Eye of Terror or the Maelstrom. As such, a Chaos incursion is usually a problem of raiders than the massed attack of a large fleet of deranged heretics. However, Tempestus is notorious for genestealer infestation as well as Ork and Eldar buccaneering. Therefore, there has been a tendency for Tempestus battlefleets to concentrate on small flotilla and anti-piracy tactics rather than a Grand Fleet strategy. To this end the Battlefleet places a greater reliance on large numbers of older, smaller warships than is typical for most other fleets.

In the 36th Millennium, a group of Tempestus

THE FORGE WORLD OF BAKKA

Bakka is a young world, a squalling brat of a world. Left alone, it might have matured, passed through adolescence into tolerant middle age, and raised a plethora of biological children. But it never had that chance because the restless agents of mankind claimed it for their own, greedy for its abundant and available mineral wealth. The surface of Bakka consists of black island rafts of basalt and granite that float on a glowing viscous sea of cooling lava. Every so often, turbulent flows or a meteorite strike causes fresh magna to burst through the thin skin on the surface of the orange seas and throw incandescent fountains of yellow fire into the sky. The atmosphere is hot, acrid and exceedingly poisonous; oxides of nitrous, sulphur and sodium mix with ammonia in spirals of yellow, brown and red fog. Giant, tracked machines extract minerals when convective flow forces important ores near the surface of the seas. The loss rate among the ore processing workers is substantial, and commonly penitents and heretics are assigned to the duty. The punishment for a penitent and a heretic is the same. Naturally, the Emperor rejoices at the righteous remorse of a penitent but the sin must still be cleansed by punishment.

Permanent installations are built on the black rafts of basaltic rock. In the reinforced adamantium walls of the fortress-like plants, ore is processed into usable materials. Heavy laser batteries are mounted on the strengthened roofs of the squat, dark structures to blast away



meteors - and the Emperor's foes, as technological developments to defend against the ever-present threat of asteroid impacts were easily applied to low-orbit and later ship-based defenses. Most of the manufacturing facilities hang above the planet in geostationary orbit, and here are also found the vast sprawling dockyards of the Segmentum Tempestus Sector Naval Base.

THE FIRST TYRANIC WAR

One of the most famous battles involving Battle Fleet Bakka took place during the First Tyrannic War. Tyranids had cut a swath through the Dominion of Ultramar, the Ultramarine homeworld of Macragge itself was under heavy attack from Hive Fleet Behemoth, and the Ultramarines were being forced back, step by step, by a tide of alien horrors. Then, just when all appeared to be lost, the first squadrons of ships from Battle Fleet Bakka began to arrive. In space Marneus Calgar watched in rapt attention as reality rippled in front of the shapes emerging from the warp before parting like a curtain to reveal the familiar shapes of Imperial warships. Over two hundred Imperial eagles emblazoned the hologlobe representing heavy cruisers, missile destroyers, battleships and including a gold eagle representing the huge Emperor class capital ship Dominus Astra. The sense of relief was a palpable force aboard the ships of Ultramar. Now the Tyranids were trapped with the Tempestus fleet ahead and the Ultramar fleet behind.

The hive fleet started to decelerate and turn back in-system, seeking to destroy the lesser Ultramar force behind them. The Ultramar fleet slowed and prepared to fight again as Calgar swiftly communicated with Lord Admiral Rath, commander of the Tempestus fleet, and exchanged plans. The Ultramar fleet clumped into a tight wedge to keep the Tyranids at bay with their massed batteries while the Tempestus

vessels spread into a broad avellan cross. As the Tyranids engaged Calgar's ships the arms of the cross formed by Lord Admiral Rath's fleet closed in around them like the jaws of a trap.

The battle was short and brutal as the Tyranids were caught in the cross-fire of the two fleets. Though they were outnumbered by over three to one the Imperial ships blasted their way through the hive fleet and scattered the bio-ships into small groups. The Tyranids' piecemeal counter-attacks were beaten off by the awesome firepower of the heavily armored and shielded Imperial ships. Their lances of fusion fire transixed the organic hulls of the bio-ships and clouds of Imperial Navy fighters darted in to tear apart the crippled vessels. Within an hour the remnants of the hive fleet were dead and drifting, charred hulks spinning slowly through the void.

The battle had taken its toll of the combined fleet. Calgar had lost half his remaining ships, and several Imperial ships had to be destroyed by the weapons of their compatriots because they had been boarded and overrun by the Tyranids. The tales of horror from these vessels mirrored those from the polar fortresses on Macragge all too closely. It was evident that the Tyranids were horrifying, almost unstoppable opponents at close quarters. With the fate of the beleaguered polar garrisons pressing on his mind Calgar swiftly gathered up his fleet and turned back in-system, Lord Admiral Rath's ships swung into triumphant procession behind him. Though it would be many hours before the fleet could arrive at Macragge Calgar was determined to return in time to save his men.

Behind the two fleets the very fabric of space rippled before it was suddenly torn aside as another fleet emerged from warp space. The hologlobes were filled with ranks of red sparks as the second Tyranid hive fleet bore down on the ships of the combined Imperial fleet. This

hive fleet was fresh and undamaged: hundreds of large bio-ships made up its vanguard with their smaller companions staying to the sides and rear. Calgar desperately sought an edge to exploit against this new foe. The other fleet had only been defeated because it was surprised and weakened; this new fleet was too strong to fight. The defences of Macragge were hours away, damaged by the ongoing Tyranid assault

STARSHIP DEFENSES FOR THE ADEPTUS MECHANICUS OF BAKKA

Fleet Defense Turret

A particular Bakka innovation is the fleet defense turret, developed from the remarkably effective system of low-orbit defenses used to protect the Bakka forge world. Though exceedingly complex, the Mechanicus of Bakka found a way to incorporate this on starships as a long-range turret that can be used to protect other nearby vessels, and within a few millennia it could occasionally be found on Mechanicus vessels throughout the Imperium. Two turrets on a ship are exchanged for fleet defense turrets capable of protecting itself or any one other vessel within 15cm each ordnance phase, adding +2 to the turret strength of the ship it is defending (this does not alter bomber attack rolls when used to defend another vessel). These otherwise work exactly as normal turrets do in all other respects. When used with Battlefleet Bakka, Adeptus Mechanicus capital ships may take the Fleet Defense Turrets refit for +5 points instead of rolling for it randomly on the Mechanicus Gifts table.

Battlefleet Bakka warships need to be well equipped with turrets because of the relative lack of fighter defenses, but Fleet Defense Turrets are too complex to be serviced by ratings of the Imperial Navy. A simpler solution was devised for the warships of Battlefleet Bakka- any capital ship of Battlefleet Bakka can add +1 turret to its profile for +5 points. This upgrade does not count against refits ships can take normally. Reserve vessels may not be given this upgrade, but any vessels from the Battlefleet Bakka fleet list used as reserves in other fleets may take it with them.

but still operational. The only other defensive point was the ringed gas-giant Circe, which they could reach within the hour.

Calgar headed back to Macragge. Lord Admiral Rath declared that too many of his ships would be caught before they reached that planet and turned away toward Circe. As the ponderous ships of the Tempestus fleet swung their prows towards roiling Circe and its treacherous rings of rocks and dust the hive fleet smoothly divided itself. The greater part of the alien ships pursued the Imperial vessels towards the gas giant and its shining rings. The remainder dogged the Ultramar fleet with such numbers that to turn back would be suicidal. Amidst the rings of Circe the Imperial fleet turned at bay, their engines holding them at a dead halt above bands of storm that reached about the giant's circumference. The Tyranid ships swept forward in a wave which filled the monitors and gun sights with targets. Laser salvos and plasma beams struck down the bio-ships by tens and then hundreds but the hive fleet ground forward regardless of loss. Vessels of both sides fell towards Circe's hungry pull as they were hit, tumbling down to be smashed apart in the stony rings or to send flares of incandescent gas jetting into space as they burned amidst clouds below.

One by one the Imperial vessels were grappled and overrun or torn apart by the hail of shots from a dozen foes. The rings flared with the bright flashes of Imperial ships dying in fiery wreaths of plasma. The skies above Circe were filled with the detritus of war, charred fragments of ships and bio-ships merging together to form new rings of steel, blood and bone. At the height of the battle only a fraction of the Imperial warships remained operational, amongst them the scarred bulk of the Dominus Astra. Giving his remaining ships a final order to scatter Lord Admiral Rath swung the mighty capital' ship about and thrust forward into the heart of the hive fleet. Roaring forward on its many tails of

white fire the Dominus Astra ripped through the bio-ships with its jagged ram, weapons blasting from every gun port and turret, the enemy so close that the shot and detonation of its fusion cannon were simultaneous. For a brief instant the Dominus Astra kept the horde back with the blaze of its weapons before the Tyranids swept in like a tide of bone and flesh to cover it with their numbers.

A black globe crackled and flared into existence over the spot. Real space rippled visibly and then shuddered back before the groaning warp drives of the Dominus Astra as it hurled itself into the warp. Reality contorted under the strain: mass and warp energy collided in a cataclysmic implosion of black light and impossible sound. All of the closest Tyranid ships were dragged into the Astra's displacement and were lost with it. Those further away were smashed in the swirling storm of dust, rocks and other detritus swept into the ship's wake. Great flares of incandescent gas gouted up from Circe to incinerate the handful of surviving ships that remained in a holocaust of flame. The Dominus Astra disappeared into the warp never to be seen again. Only a dozen other ships of the proud Tempestus fleet survived the battle of Circe. These limped away towards Macragge, though the battle for the Ultramarines' homeworld would be long over by the time they arrived.



The last stand of the Ternpestus fleet was visible on magnascope, the light from Circe's orbit taking seconds to catch up with the Ultramar fleet. Calgar could only helplessly watch the Imperial vessels wreathed in the flame of their weapon fire, the silent explosion of Tyranid ships as they were struck, the glittering aurora of

lights as laser salvos vaporized rings of dust. As the Dominus Astra dragged the heart of the hive fleet to oblivion the bio-ships pursuing Calgar started to split up, the smaller vessels rushing after the Ultramar ships while their larger companions turned back and left the Macragge system. In space the survivors of the Ultramar

fleet easily destroyed the last wave of bio-ships. The Tyranids drove straight forward against the fleet and Macragge's defenses, each successive foe was destroyed before it came anywhere near the planet. Hive Fleet Behemoth had been defeated.

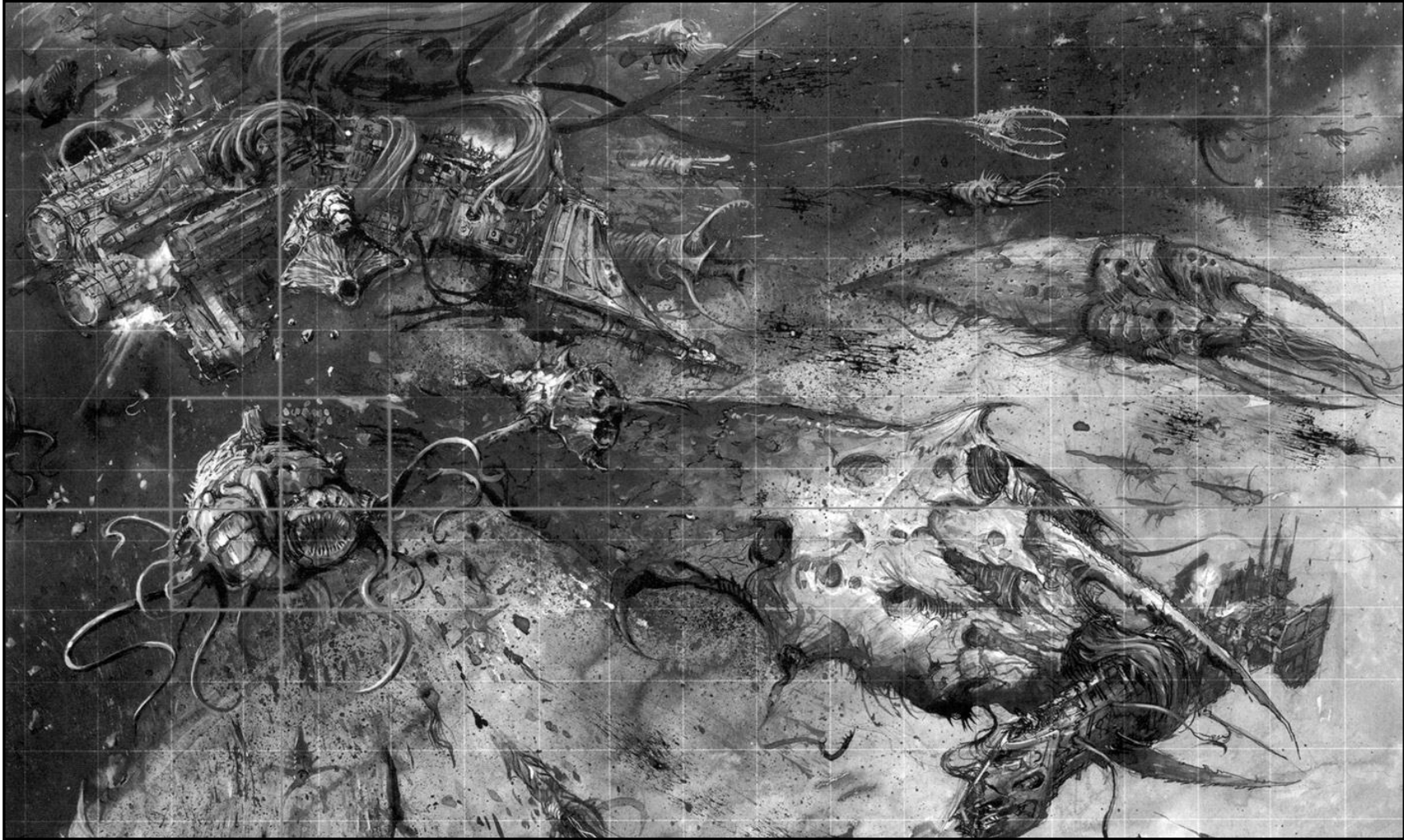

**DOSSIER: Lord Admiral
Zaccarius Rath – 200 Points**

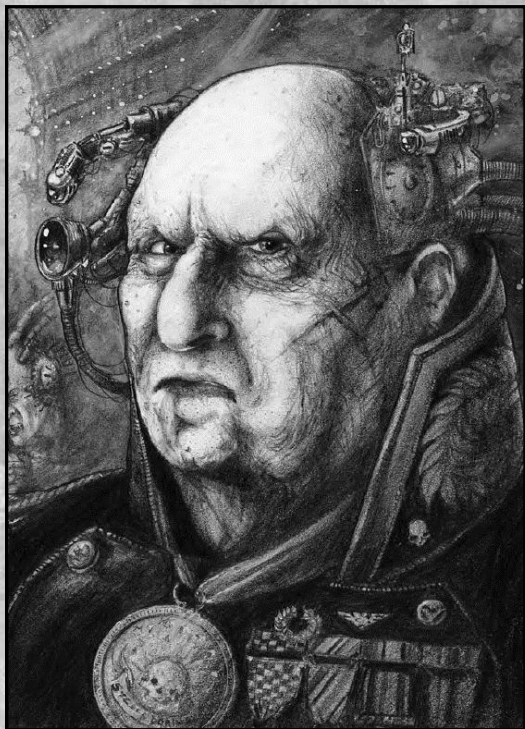

“Those far-distant, warp-beaten ships, upon which Imperial citizens never gaze, are all that stand between heresy and the dominion of the galaxy.”

- Lord Admiral Rath

Zaccarius Rath was born on Delta Prime in the Prime Sector. His father, a man who knew his own worth, was Steward to one of the estates of the hereditary Bakka. At night, the skies over Delta Prime were coloured with the 'The Blaze', the spiral arm of the galaxy passing through the Segmentum. The young Zaccarius used to lie on his back in the cool evenings watching the cold glittering stars and dreaming. To

Steward Rath's great disappointment, his only son eschewed an elegant career in the Stewardship to enlist in the Imperial Navy. Rath joined the naval cadets at Karmon College at the age of 14. He was a slightly built studious youth, and many of his instructors doubted the capability of the new cadet to survive the rough and tumble of naval life. But he did more than survive, a diamond-bright indomitable will forced him to excel. He proved adept at the epee and many a foolish, overbearing lout bore facial scars to remind them of Rath's mastery in the dueling stocks. Of course in later years, a scar received at the hand of Lord Admiral Rath became a badge of honor. Rath was commissioned as 12Sth Lieutenant into the



Cruiser *Diomedes* working steadily through the ranks. He was promoted to Damage Control Officer in the battleship *Word of the Emperor* and earned great respect for his organizational skills. He also won a Bakka Purity Commendation for leading a counterattack on Ork boarders, slaying the Ork Chieftain personally with a broken cutlass. While his courage was unquestioned, it was as Flag Tactical Officer for the 34th Destroyer Flotilla that Rath's strategic genius began to show. In a series of brilliant engagements, his devious mind plotted the downfall of the Eldar Pirates of the Ganzona Rift. Wherever the faster, theoretically more maneuverable, Eldar fled they found Cobra gunships already turning into attack runs.



From then on, the 34th were known as Rath's Marauders. The Ganzona Rift War won Rath his Flag Rank and the Azure Medallion. Rath became Battlefleet Bakka's supreme strategist. Lord Admiral

Vannion claimed that Rath's presence on the bridge was worth an additional squadron of battleships. In due time Rath replaced Vannion as Lord Commander of all naval assets in the Bakka Sector. The Ultramar expedition was the largest armada of warships ever sent out of the Segmentum. There was never any doubt who would lead the force.

Lord Admiral Rath 200 points
An Imperial Bakka Battlefleet 1,500 points or greater may be led by Lord Admiral Rath, who must always be placed on a battleship, though it not necessarily be the most expensive one present.

Lord Admiral Rath is Ld-10 and comes with two re-rolls as part of his point cost. His crew is honored and inspired by the great man's presence and will fight with great courage and pride; they add +1 to their roll when defending against boarding actions. Respect for him extends to the forge world of Bakka itself, and his flagship receives one ship refit and weapon refit (rolled randomly) as part of his point cost. In a campaign, a ship so refitted must remain his flagship unless it is destroyed.

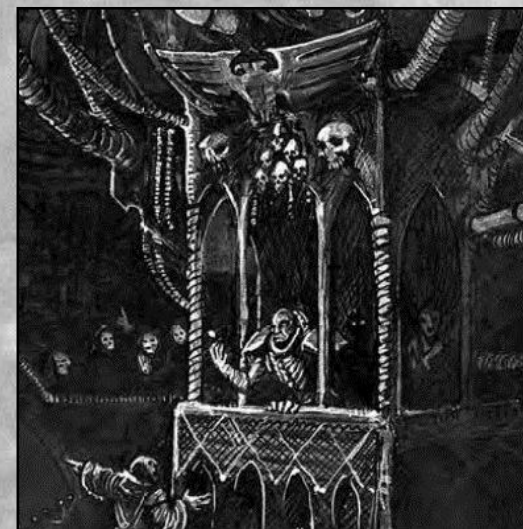

VICTORY CLASS BATTLESHIP 345 Points

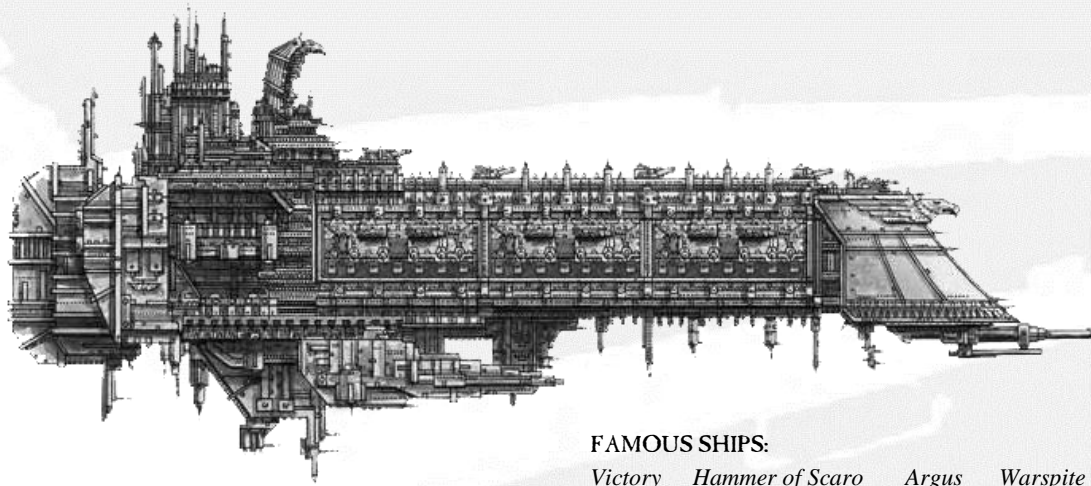

FAMOUS SHIPS:

Victory Hammer of Scaro Argus Warspite

| TYPE /HITS | SPEED | TURNS | SHIELDS | ARMOR | TURRETS |
|------------------------|--------------|--------------------|---------|--------------------|---------|
| Battleship/12 | 20cm | 45° | 4 | 6+ prow/5+ | 4 |
| ARMAMENT | RANGE | FIREPOWER/STRENGTH | | FIRE ARC | |
| Port Lances | 60cm | 4 | | Left | |
| Starboard Lances | 60cm | 4 | | Right | |
| Dorsal Weapons Battery | 60cm | 6 | | Left/ Front /Right | |
| Prow Nova Cannon | 30cm - 150cm | 1 | | Front | |

Special Rules: Victory-class battleships are ponderous vessels and cannot use Come To New Heading special orders. The *Hammer of Scaro* may replace its Nova Cannon with strength-9 torpedo launchers for -10 points.

Emperor Battleship *Dominus Astra* – 365 Points

Emperor Class battleships are among the oldest to serve in Imperial Fleets and are commonly used as flagships. Only one member of this class, the venerable *Dominus Astra*, saw action against Hive Fleet Behemoth while serving as Lord Admiral Rath's flagship. The *Dominus Astra* was lost in combat at the Battle of Circe in the Macragge system when an Imperial Fleet of 200 vessels was overwhelmed by Tyranids. In order to cover the disengagement of the surviving twelve Imperial capital ships, Lord Rath ordered the battleship into the heart of the enemy fleet, ripping through their formations with all guns blazing. As the alien hordes closed around the doomed ship, the *Dominus Astra* engaged its warp drives, tearing apart real space, dragging large numbers of the unholy foe into the immaterium and dashing many others onto the rings around the gas giant. The *Dominus Astra* was never officially seen again although rumors abound of a mysterious ghost ship that appears from the warp in time of greatest peril to hurl itself on humanity's most dangerous enemies.

As a result of the fallout subsequent to the Gareox Prerogative, this class of vessel is extremely rare in the fleets of Segmentum Tempestus. Bakka fleets may only field Emperor battleships as reserves unless Admiral Rath leads the fleet, in which case it must be his flagship.

In internal layout, the Victory class shares many similarities with Retribution, and Imperial Navy analysts speculate the design is a byproduct of grafting lance weaponry onto the improved power conduits and relays of the Retribution template in an attempt to replicate the Apocalypse battleship class while overcoming various shortfalls inherent with that ancient design. In this respect it has proven successful, though it still is not capable of delivering the level of firepower that ancient class was capable of when the Imperium was still able to reliably fabricate its sophisticated but difficult to maintain power transfer relays. Nonetheless, the Victory makes up for firepower with its far more robust and reproducible design, and it has had many successes throughout the Tempestus and Ultima Segmentae. The Technomagi of Mars refuse all requests for access to their records of origin, and the shipwrights of Bakka have proven to be equally recalcitrant.

Four Victory class battleships serve in Battlefleet Bakka, the *Victory* being by far the oldest. The *Argus* particularly distinguished itself, leading the fleet that cleaned the Stabulo systems of the deviants that polluted various sectors along the border region between Segmentum Tempestus and Ultima. The *Hammer of Scaro* was rebuilt with prow torpedoes instead of replacing its Nova Cannon after receiving severe damage ramming the Ork Hulk *Gungedrinka* at the Battle of Lexus. All four of Bakka's Victory battleships served against Hive Fleet Behemoth, and three returned from the pivotal Battle of Circe.

VANQUISHER CLASS BATTLESHIP 300 Points

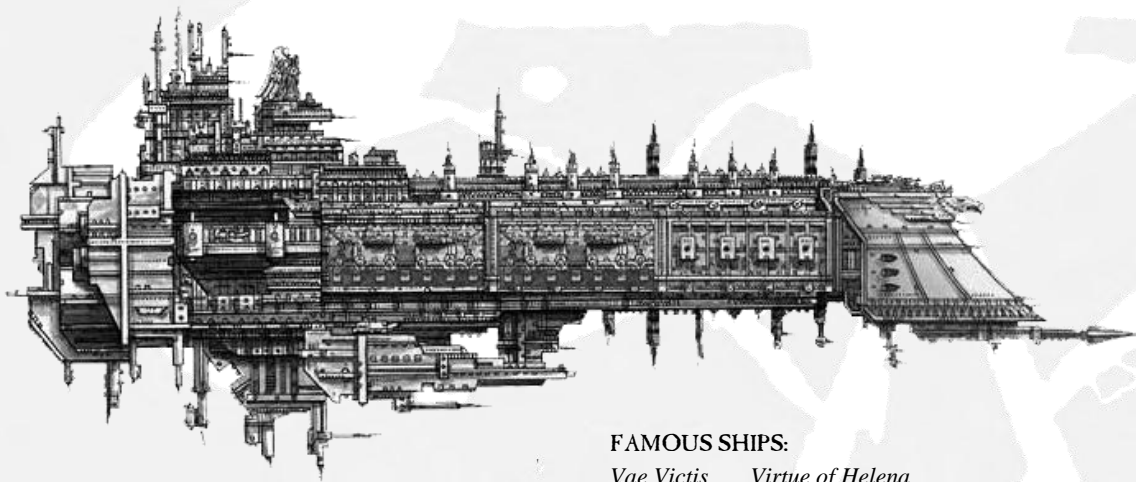

FAMOUS SHIPS:
Vae Victis *Virtue of Helena*

| TYPE /HITS | SPEED | TURNS | SHIELDS | ARMOR | TURRETS |
|---------------------------|-------------|--------------------|---------|------------|---------|
| Battleship/12 | 15cm | 45° | 4 | 6+ prow/5+ | 5 |
| ARMAMENT | RANGE | FIREPOWER/STRENGTH | | FIRE ARC | |
| Port Lances | 45cm | 4 | | Left | |
| Starboard Lances | 45cm | 4 | | Right | |
| Port Weapons Battery | 60cm | 6 | | Left | |
| Starboard Weapons Battery | 60cm | 6 | | Right | |
| Prow Torpedoes | Speed: 30cm | 6 | | Front | |

Special Rules: Vanquisher-class battleships are ponderous vessels and cannot use Come To New Heading special orders.

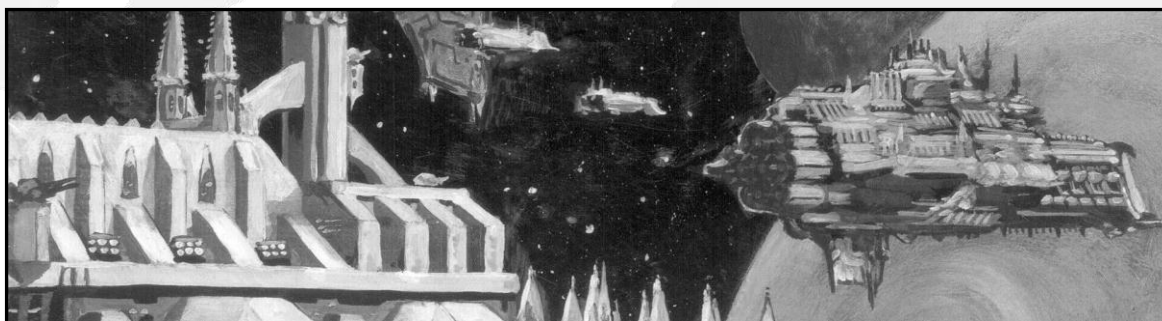

The Vanquisher class battleship is regarded by analysts as an ancient design even by the standards of the Imperial Navy. The *Vae Victis* in particular has an extensive and storied history long pre-dating its joining Battlefleet Bakka. What records survive indicate it was constructed in the orbital shipyards of Hydraphur in the late 32nd millennia, built at the request of High Lord Javor. Following its construction the battleship saw action during the Pacification of Magdellan and the Saint-Saen Crusade. Whilst on this extended crusade the vessel was recorded 'lost in warp' with all hands. Believed thrown wildly off course by warpstorms the *Vae Victis* returned some 200 years later. Records do not detail the intervening years.

The next verifiable records of this vessel come from its service in the Ultima Segmentum, where it served for a time as part of the Dominion Fleet of the Ultramarines. Over the next millennia the ship underwent an extensive refit to repair extensive damage to its lance batteries and propulsion system, but the circumstances surrounding when this damage was sustained are unknown.

Aged and suffering continued problems with its engines, the *Vae Victis* was mothballed as part of the fleet reserve in the 38th millennia and left in a stationary orbit around Drawkesd in Segmentum Tempestus along with three other vessels of this class. Weapon and shield systems were stripped for reuse. For long centuries the battleship was left to decay in a forgotten backwater. Following the Battle of Circe, increased pressure on Imperial Navy Segmentum resources led to the *Vae Victis* being recommissioned. All four surviving examples of this class are currently undergoing re-armament and crew training before resuming active service to make up for the horrific losses from that battle.

JOVIAN CLASS BATTLECRUISER 260 Points

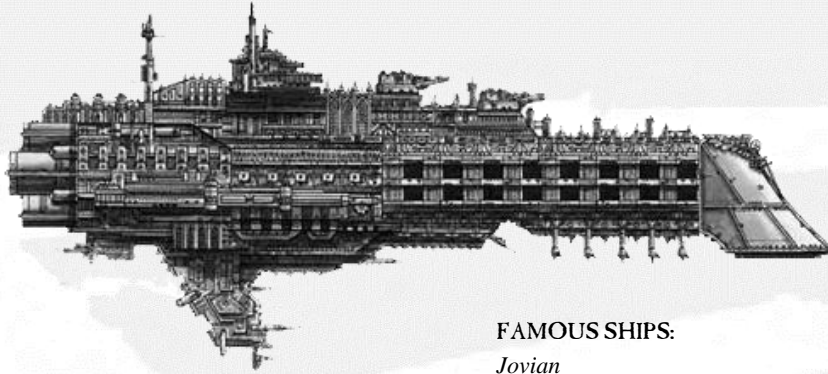

FAMOUS SHIPS:
Jovian

| TYPE /HITS | SPEED | URNS | SHIELDS | ARMOR | TURRETS |
|------------------------|------------------------------|--------------------|---------|--------------------|---------|
| Cruiser/8 | 20cm | 45° | 2 | 6+ prow/5+ | 3 |
| ARMAMENT | RANGE | FIREPOWER/STRENGTH | | FIRE ARC | |
| Port Launch Bays | Fury: 30cm Starhawk: 20cm | 3 | | N/A | |
| Starboard Launch Bays | Fury: 30cm Starhawk: 20cm | 3 | | N/A | |
| Dorsal Lance Batteries | 60cm | 2 | | Left/ Front /Right | |

Special Rules: The *Jovian* was fitted with an improved sensor array during its conversion to accurately control its prodigious squadrons of attack craft. It gains a +2 bonus when the enemy is on special orders instead of +1. Its prow Nova Cannon was never replaced after the Stabulo Campaign; if the ship suffers prow critical damage, it may ignore the result entirely instead of moving up the table to Engine Room Damaged.

The *Jovian* is a unique vessel. Only one may be included in an Imperial fleet. It is a reserve vessel of Battlefleet Bakka and can only be used as such by Bakka fleets and not with other fleet lists.

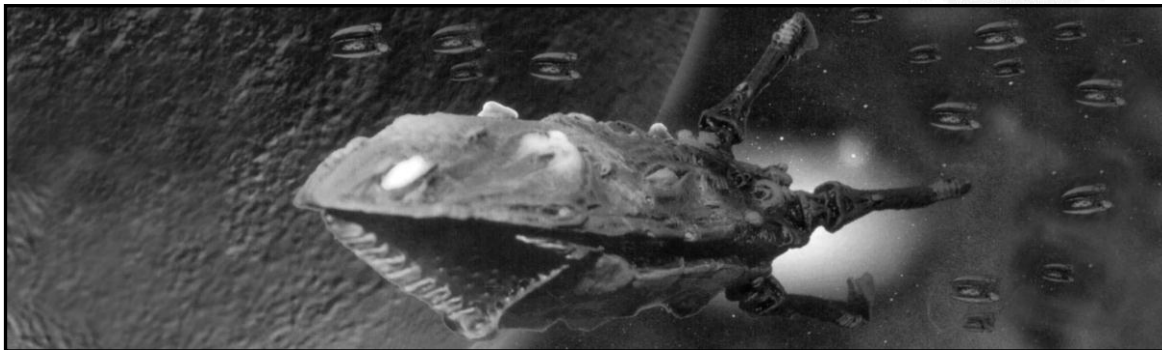

The *Jovian* is viewed with misgivings by many authorities in Battlefleet Bakka, as history and tradition are hard to set aside in the Imperial Navy in general and by the fleetlords of Bakka in particular. With the history of the Garerox Prerogative required reading in the fleet academies, the very idea that the Imperial Navy should need a dedicated attack craft carrier is viewed as anathema. However, the horrors of the First Tyranic War cast a negative light on Battlefleet Bakka's inherent distrust of attack craft, and while their tactics of relying on massed battery and lance fire proved effective, it was only prudent that more attack craft should be made available to support the battlefleet.

While the prodigious output of a Mechaincus forgeworld can see a new cruiser put to space several times a year, this is only through economies of scale, as a single cruiser hull can take more than a decade to construct from the keel-up for even the best and most well-supplied shipyards, and many smaller shipyards take decades and the resources of an entire world to construct a single such vessel. To this end the encroaching Tyranid fleet meant Bakka had no time for such an endeavor. Salvation came in the form of the *Jovian*, a venerable Mars battlecruiser laid up after having its prow and forward battery decks smashed apart during the Stabulo Campaign. Languishing for centuries as resources were applied to more pressing matters, the process of converting its damaged battery decks into launch bays proved to be relatively straightforward. Completed with too little time even for proper space trials but with a full complement of Bakka's ablest attack craft crews, the *Jovian* acquitted itself well and was one of the twelve capital ships able to fight its way back to Bakka after the crucial Battle of Circe. Despite its success, the fleetlords of Bakka hold fast to their big-gun philosophy, and it is unlikely another ship of this class will be requisitioned by Segmentum Naval authority.

DOMINION CLASS BATTLECRUISER 260 Points

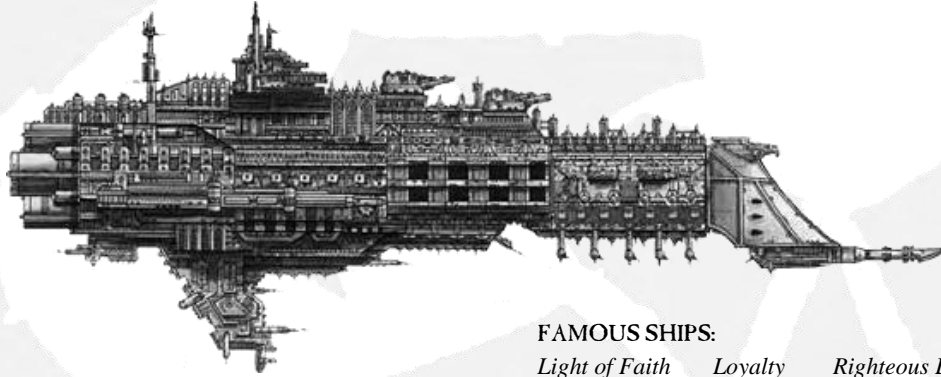

FAMOUS SHIPS:
Light of Faith *Loyalty* *Righteous Endeavor*

| TYPE /HITS | SPEED | TURNS | SHIELDS | ARMOR | TURRETS |
|---------------------------|------------------------------|--------------------|---------|--------------------|---------|
| Cruiser/8 | 20cm | 45° | 2 | 6+ prow/5+ | 3 |
| ARMAMENT | RANGE | FIREPOWER/STRENGTH | | FIRE ARC | |
| Port Launch Bays | Fury: 30cm Starhawk: 20cm | 2 | | N/A | |
| Starboard Launch Bays | Fury: 30cm Starhawk: 20cm | 2 | | N/A | |
| Port Lance Batteries | 45cm | 2 | | Left | |
| Starboard Lance Batteries | 45cm | 2 | | Right | |
| Dorsal Lance Batteries | 60cm | 2 | | Left/ Front /Right | |
| Prow Torpedoes | Speed: 30cm | 6 | | Front | |

The Dominion-class battlecruiser was envisioned as a more modern replacement to the Mars, designed to serve as a capable fleet support vessel optimized for the role envisioned for attack craft carriers by the fleetlords of Bakka. While its launch bays and lance batteries were well-suited to provide an adjunct to the fleet maneuvers favored by the “big-gun” lobby, the class fared poorly in smaller engagements and suffered from many of the shortcomings of the Gothic cruiser in the kinds of raids more typically faced by the dispersed flotillas of the battlefleet. In particular, the *Light of Faith* had a rather inauspicious start to its career when it and its escorts were driven out of an uncharted system by Necron raiders during its maiden deployment. Additionally, the *Perseverance* was lost with all hands during the Stabulo campaign, and the *Ascension* disappeared together with the rest of Commodore Fyne's battlegroup during a protracted war in the Nemesis Sector.

These outcomes led the Imperial Navy to cease ordering production of these vessels after only ten hulls were constructed. Despite this, tactical analysis of these engagements shows that the Dominions had invariably performed only as well as could be expected from them in very adverse conditions, and they had incidentally displayed their considerable potential as fleet support vessels with their long-range lances and ordnance deployment capability. In fact, these ships acquitted themselves admirably during the War for Maccrage, and of the two Dominion-class warships present at the Battle of Circe, the *Light of Faith* was one of the twelve capital ships that returned, redeeming in hard-won victory the honor lost from its fateful maiden deployment centuries before.



The Emperor helps those who aim their lances well.
Traditional Saying

MERCURY CLASS BATTLECRUISER 255 Points

In the waning years of Abaddon's 12th Black Crusade, the Adeptus Mechanicus Artisans of Bakka and the officers of Battle Fleet Tempestus faced a dilemma. In supporting Battle Fleet Obscuras, the problem with pirate bands had become acute and the lack of speed among the standard Imperial cruiser designs meant that the tactical initiative remained with the pirates. At the direction of Admiral Knightsbridge, the Tech Mages of Bakka set about to construct a new battle cruiser design fitting for the

strategy and tactics of the battlefleet yet be able to meet this threat. Through a rather straightforward merging of existing technologies, the Adeptus Mechanicus were able to devise a solution in less than two centuries. It is widely believed that this is the fastest a new capital ship design has ever come to fruition in several millennia, and thus the Mercury class battlecruiser came into being.

Built from the keel up to prosecute raiders, the Mercury combines a basic cruiser layout with

the engineering suite normally used on a battleship. The result is a faster much more powerful cruiser with the speed to keep up with the raiders and the firepower to deal with them as an independent unit. All this improved performance came at a price. While the engines produced battleship power, the armor protection remained that of a cruiser. When hit by multiple salvos from Chaos raiders in 467.M41, the *Scylla* suffered a powerful warp drive implosion, destroying her entire squadron of assigned escorts and heavily damaging the battleship *Mailed Fist*. The plasma drive overload that destroyed the *Medusa* also shattered the Lunar cruiser *Lord Chalfont*, leaving a convoy of transports to the mercies of an Ork raiding squadron.

Despite its shortcomings, many Bakka Naval officers aspire to someday lead one of these fearsome warships. The *Nemesis* destroyed an Ork Terror Ship and three Ravagers single-handed, and the *Gorgon* claimed the Eldar Shadow class cruiser *Swift Striker* while protecting a vital supply convoy.

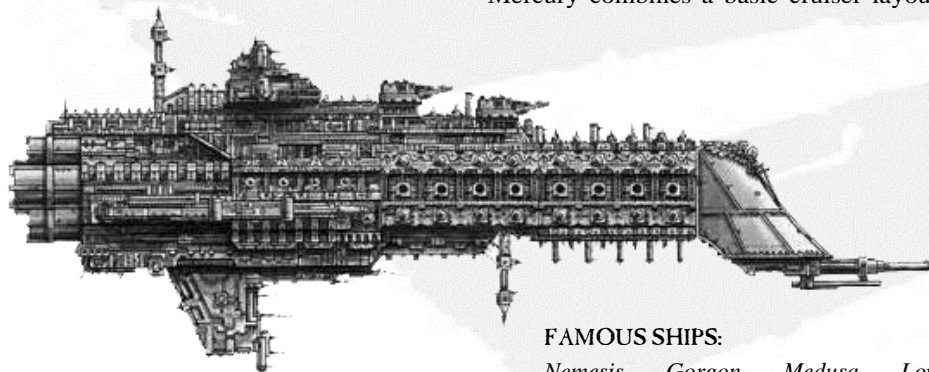

FAMOUS SHIPS:
Nemesis Gorgon Medusa Long Serpent

| TYPE /HITS | SPEED | TURNS | SHIELDS | ARMOR | TURRETS |
|---------------------------|-------|--------------|--------------------|------------|--------------------|
| Cruiser/8 | 25cm | 45° | 2 | 6+ prow/5+ | 2 |
| ARMANENT | | RANGE | FIREPOWER/STRENGTH | | FIRE ARC |
| Port Weapons Battery | | 60cm | 6 | | Left |
| Starboard Weapons Battery | | 60cm | 6 | | Right |
| Port Weapons Battery | | 45cm | 4 | | Left |
| Starboard Weapons Battery | | 45cm | 4 | | Right |
| Dorsal Lance Batteries | | 60cm | 2 | | Left/ Front /Right |
| Prow Nova Cannon | | 30cm - 150cm | 1 | | Front |

Special Rules: Mercury class battlecruisers are fitted with up-rated engineering plants that increase its speed and provide it with greater firepower at the expense of survivability. When reduced to zero hits, it rolls 3D6 for catastrophic damage and adds the result (any roll greater than 12 counts as 12).

The *Nemesis* and *Medusa* were refitted with improved weapon batteries after the Stabulo Campaign. Its 45cm weapon batteries increase their range to 60cm for +10 points. The *Gorgon* had its prow severely damaged during the Stabulo Campaign and replaces its Nova Cannon with strength-6 torpedoes for -20 points.



ENDEAVOUR CLASS LIGHT CRUISER 115 Points

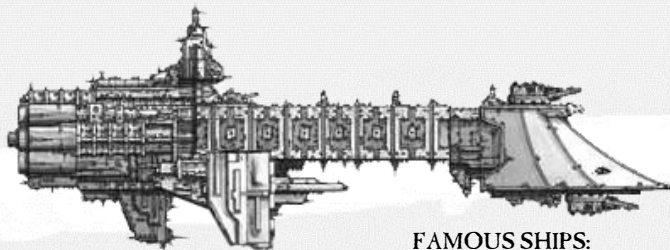

FAMOUS SHIPS:

Resolute King Horaxe Emperor's Shield

| TYPE /HITS | SPEED | TURNS | SHIELDS | ARMOR | TURRETS |
|---------------------------|-------------|--------------------|---------|--------------------|---------|
| Cruiser/6 | 20cm | 90° | 1 | 5+ | 3 |
| ARMANENT | RANGE | FIREPOWER/STRENGTH | | FIRE ARC | |
| Port Weapons Battery | 30cm | 6 | | Left | |
| Starboard Weapons Battery | 30cm | 6 | | Right | |
| Prow Weapons Battery | 30cm | 2 | | Left/ Front /Right | |
| Prow Torpedoes | Speed: 30cm | 2 | | Front | |

Endeavour and Endurance class light cruisers are popular as convoy flagships and are commonly seen paired together in Battlefleet Bakka. The most famous convoy leader in Battlefleet Bakka is the *Resolute*. This ship has accounted for more than 17 pirate ships and 204 attack craft in its 400 year career. It particularly distinguished itself at Heaven's Split where, with only two under-strength squadrons of Cobras, it fought off continuous waves of Ork attack craft for two days until the escort squadron *Silver Wolves* drove off the grenskins. Admirals have also found these classes effective as fleet escorts, and it has become common practice to pair battleships and light cruisers in Battlefleet Bakka. Because of the role these ships fulfill within the fleet, many of the Fleet Defense turrets constructed at the Bakka shipyards have been requisitioned for these ubiquitous vessels. Despite horrific losses, these warships served with great valor during the First Tyranic War.

ENDURANCE CLASS LIGHT CRUISER 115 Points

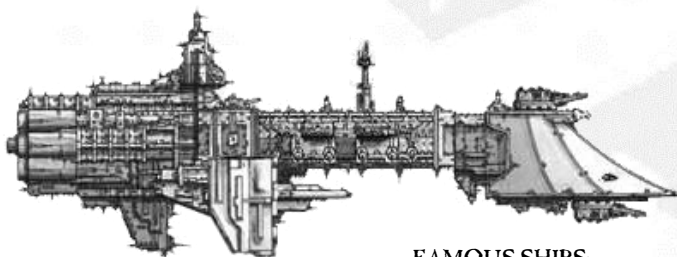

FAMOUS SHIPS:

Imperial Ghost Dux Cornovi

| TYPE /HITS | SPEED | TURNS | SHIELDS | ARMOR | TURRETS |
|-------------------------|-------------|--------------------|---------|--------------------|---------|
| Cruiser/6 | 20cm | 90° | 1 | 5+ | 3 |
| ARMANENT | RANGE | FIREPOWER/STRENGTH | | FIRE ARC | |
| Port Lance Battery | 30cm | 2 | | Left | |
| Starboard Lance Battery | 30cm | 2 | | Right | |
| Prow Weapons Battery | 30cm | 2 | | Left/ Front /Right | |
| Prow Torpedoes | Speed: 30cm | 2 | | Front | |

Special Rules: The Endeavor light cruiser is one of the most widely-encountered capital ship classes throughout the Imperium, and it appears in a great diversity of hull patterns that vary in a number of respects from similar class vessels from other fleets. Endeavor and Endurance class light cruisers of Battlefleet Bakka are typically deployed in solitary patrols or in pairs throughout the wilderness space of Segmentum Tempestus, or as "flak ships" in support of fleet formations. Their turret strength is 3 as part of their basic profile and point cost. This does not affect their ability to take +1 turret for +5 points.

The specifications for these vessels relied heavily on a degree of compartmentalization that proved too cumbersome for later ship designs. However, this facilitates defending against boarding actions, and these ships add +1 to their dice roll when doing so.

Endeavor and Endurance light cruisers may upgrade their prow armor to 6+, but their turn rate is reduced to 45° if this option is taken.

SILURIA CLASS LIGHT CRUISER 100 Points

| TYPE /HITS | SPEED | TURNS | SHIELDS | ARMOR | TURRETS |
|---------------------------|-------|-------|--------------------|-------|--------------------|
| Cruiser/6 | 25cm | 90° | 1 | 5+ | 1 |
| ARMAMENT | | RANGE | FIREPOWER/STRENGTH | | FIRE ARC |
| Port Weapons Battery | | 30cm | 6 | | Left |
| Starboard Weapons Battery | | 30cm | 6 | | Right |
| Prow Weapons Battery | | 30cm | 2 | | Left/ Front /Right |

Special Rules: Siluria light cruisers go an additional +1D6cm when on All Ahead Full special orders.

The Siluria-class light cruiser is a much older design than the Endeavor or Dauntless, but a small number continue to serve the space lanes of Segmentum Tempestus. The Siluria is best suited to supporting battle fleets rather than undertaking missions on its own. However, a full broadside from one of these ships is more than capable of causing great damage, so these vessels tend to be well screened until the time to unleash its weapons arrives. During the Phillipa campaign, the Siluria cruisers *Vanguard* and *Thebes* served with particular renown.

HAVOC CLASS FRIGATE 35 Points

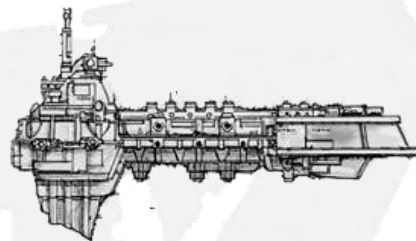

FAMOUS ESCORT SQUADRONS:
Sons of Ogala *125th Ghost Wing*

| TYPE /HITS | SPEED | TURNS | SHIELDS | ARMOR | TURRETS |
|-----------------|-------|-------|--------------------|-------|--------------------|
| Escort/1 | 25cm | 90° | 1 | 5+ | 2 |
| ARMAMENT | | RANGE | FIREPOWER/STRENGTH | | FIRE ARC |
| Weapons Battery | | 30cm | 3 | | Left/ Front /Right |
| Weapons Battery | | 30cm | 2 | | Front |

Like the Siluria class light cruiser, the Havoc frigate is an old design harking back to a time when classes such as itself and the Pretor-class destroyer were not yet superseded by newer and now ubiquitous escort classes like the Sword and Cobra. Even among the fleets of Segmentum Tempestus the class is not commonly encountered, and the vessel is more often found in the company of Rogue Traders than in the service of the Imperial Navy. Unfortunately, this aspect has also made it a favorite of raiders as well, and a number of these ships have needed to be hunted down and destroyed after falling in the hands of pirates and renegades. It nonetheless was an important escort in its time, and aspects of its design were later incorporated in both the Sword and Falchion frigate classes.

VIPER CLASS DESTROYER 35 Points



FAMOUS ESCORT SQUADRONS:
Rat Runners *76th Silver Spears*

| TYPE /HITS | SPEED | TURNS | SHIELDS | ARMOR | TURRETS |
|----------------|-------|-------------|--------------------|-------|----------|
| Escort/1 | 30cm | 90° | 1 | 4+ | 1 |
| ARMAMENT | | RANGE | FIREPOWER/STRENGTH | | FIRE ARC |
| Prow Torpedoes | | Speed: 30cm | 3 | | Front |

During the Gareox Prerogative, many Cobra destroyers were converted to carry boarding torpedoes. Their main weapon battery was removed and extra torpedo launch tubes added. The experiment was not a success; escorts could not carry large enough crews to man the torpedoes properly and fight the ship. These ships have proven to be poor convoy escorts but have been surprisingly successful in fleet support flotillas. As such, most Vipers have been retained in this capacity and continue to be constructed, though they no longer use boarding torpedoes.

SEGMENTUM TEMPESTUS, BAKKA SECTOR FLEET LIST

FLEET COMMANDER

0-1 Admiral

You may include one Admiral in your fleet, who must be assigned to a ship and improves its Leadership to the value shown. If the fleet is worth over 750 points an Admiral must be included to lead it.

| | |
|------------------------------------|------------|
| Fleet-Admiral (Ld 8) | 50 points |
| Admiral (Ld 9) | 100 points |
| Solar Admiral (Ld 10) | 150 points |
| Lord Admiral Rath (Ld10) | 200 points |

Admirals get one Fleet Commander re-roll included in their points cost (Lord Admiral Rath has two). Additional re-rolls may be purchased for the listed point costs (including for Admiral Rath).

| | |
|--------------------------------|------------|
| One extra re-roll | 25 points |
| Two extra re-rolls | 75 points |
| Three extra re-rolls | 150 points |



CAPITAL SHIPS

Battleships

You may include up to one battleship in your fleet for every three cruisers or battlecruisers. If taken as reserves, grand cruisers do not count for this purpose. An Emperor class battleship can only be taken as reserves unless Admiral Rath leads the fleet.

| | |
|--|------------|
| (0-1) Emperor class battleship | 365 points |
| Victory class battleship | 345 points |
| Retribution class battleship | 345 points |
| Vanquisher class battleship | 300 points |

Battlecruisers

You may include up to one battlecruiser in your fleet for every two cruisers.

| | |
|--|------------|
| Dominion class battlecruiser | 260 points |
| Mercury class battlecruiser | 255 points |
| Armageddon class battlecruiser | 235 points |

0-12 Cruisers

You may include up to twelve cruisers in your fleet. There is no restriction for the number of Endurance light cruisers taken in a Bakka fleet.

| | |
|---|------------|
| Dominator class cruiser | 190 points |
| Tyrant class cruiser | 185 points |
| Lunar class cruiser | 180 points |
| Gothic class cruiser | 180 points |
| Endeavour class light cruiser | 115 points |
| Endurance class light cruiser | 115 points |
| Siluria class light cruiser | 100 points |



ESCORTS

You may include any number of escorts in your fleet, in squadrons of 2-6 escorts.

| | |
|---------------------------------|-----------|
| Sword class frigate | 35 points |
| Havoc class frigate | 35 points |
| Viper class destroyer | 35 points |



ORDNANCE

Any ship with launch bays may use any mix of Fury interceptors and Starhawk bombers. They may also take torpedo bombers for +10 points per launch bay. An Emperor class battleship may carry Shark assault boats at an additional cost of +5 points. Ships with torpedo tubes are armed with ordinary torpedoes.



THE ADEPTUS MECHANICUS OF BAKKA

Because the Bakka Forge World serves as the headquarters of Battlefleet Bakka, the Adeptus Mechanicus have a close relationship with the fleet. In a Bakka fleet list, cruisers from the Adeptus Mechanicus fleet list may be taken instead of and in the same manner as Imperial Navy battlecruisers, counting as battlecruisers against any fleet limits in all respects. They utilize all rules for Adeptus Mechanicus vessels except as follows: they do not count as reserves, they will not disengage when crippled and they may use fleet commander re-rolls.

However, the fleet may not be led by nor take an Archmagos when used this way.



RESERVES

Ships from any Imperial fleet list may be used as reserves, with one reserve cruiser, battlecruiser or grand cruiser for every three Bakka cruisers in the fleet, one reserve battleship for every three Bakka battleships in the fleet, etc. One Rogue Trader cruiser and its attendant escorts may be taken for every 750 points in the fleet. Ships from the Bakka fleet list can be used as reserves by any other Imperial fleet list, along with their Bakka-specific refits. Reserve cruisers (not battlecruisers or grand cruisers) always count toward the twelve-cruiser fleet limit.

(0-1) Jovian class battlecruiser 260 points
One cannot take as reserves the reserves of another fleet list. As such, ships such as the Jovian that are part of the reserve fleet of Battlefleet Bakka cannot be used as reserves of another fleet list.



THE SHIPS OF BATTLEFLEET BAKKA

Segmentum Tempestus consists of relatively few inhabited systems with vast tracts of wilderness space between them. To increase the number of available ships, Bakka utilizes many older and/or smaller ship designs not commonly encountered in other fleets.

A Vanquisher battleship can easily be represented by using a Retribution hull and not installing any dorsal turrets. Siluria light cruisers may be represented if desired as easily as cutting off the prow lances of a Dauntless light cruiser. Havoc frigates may be represented with Chaos Infidel raiders, painted appropriately in loyalist colors of course! On the other hand, the unique ship classes of Battlefleet Bakka may be represented in any manner desired by the player as long as they can be easily recognized by an opponent.

HOLY ORDERS OF THE EMPEROR'S INQUISITION

GUARDIANS OF PURITY AMIDST THE IMPERIUM OF MAN

Far underneath the bedrock of Antarctica on Holy Terra exists the citadel of an organization that acts as the secret police of the Imperium of Man, hunting down any and all threats to the stability of the God-Emperor's realm. The most shadowy and mysterious of the Emperor's organizations, it is responsible for defending against perils of heresy, possession, alien dominance and rebellion. It is they who stand between all mankind and the phantoms of fear and terror lurking in the darkness between the stars.

THE ORDOS MAJORIS

From beginnings shrouded in mystery and dating back to the Horus Heresy, it is believed that the Inquisition coalesced into the beginnings of its current form by the beginning of M32, 800 years after the Heresy, although its essential components and apparatus, such as the League of Blackships and the "Witch Hunters" of the Sisters of Silence were active before the Heresy began. While it is believed the Ordos were riven with various factions almost since its inception, as a whole it existed as a single unified organization charged with examining and hunting down all the myriad threats to the Imperium, from the corruption caused by Chaos, heretics, mutants and rebels, to assaults from vicious alien species like the Tyranids, Orks or Dark Eldar, with only the Ordo Malleus existing as a separate entity to police the Inquisition itself. Though not expounded upon even among other Inquisitors not so initiated, its other, secret purpose was dealing with the threat of Chaos to the Imperium as a whole and in particular to those within the Inquisition that may be drawn to it for whatever purpose, whether malign or with the best of intentions.

It was only after the Age of Apostasy brought about by High Lord Goge Vandire and his Reign of Blood early in M36 that significant changes came about to

the Inquisition. The Ordo Malleus was rent in two under a powerful new mandate, becoming one of what became three Ordos Majoris in its own right, each one tasked with a specific area of concern in defense of the God-Emperor and his Imperium.

THE ORDO HERETICUS – THE THREAT WITHIN

Rather than serve merely as the internal investigators of the Inquisition itself, the Ordo Hereticus was made responsible for protecting the Imperium from itself and guarding its future so that never again would it be threatened by those entrusted with its protection. Hereticus Inquisitors are the most feared members of the Inquisition, as their focus is on mankind itself against the witch, the heretic and the mutant, and they are pitiless with those who fail the Emperor. The arrival of an Ordo Hereticus Inquisitor on a world is met with fear and awe, as no one but the Inquisitor himself knows where his attentions will fall. As part of this mandate, it is to this Ordo falls responsibility for investigating the psyker taint, and it is in this capacity that they arouse the most fear and suspicion.

The dread starships that make up the fleet of the League of Blackships are under the express jurisdiction of the Adeptus Astra Telepathica, but the very nature of a Blackship's mission makes strict oversight by the Inquisition a necessity. As these titanic barges ply the atramentous void on routes between heavily populated worlds and Holy Terra seeking out psykers for examination, it is common for Inquisitors of the Ordo Hereticus to travel on board, as this gives them the opportunity to investigate a planet's potential for psychically-based corruption. To this end they are also captained by senior Inquisitorial agents and embarked by a ship-based defense force of Inquisitorial Storm Troopers

or Sisters of Battle. Those few found strong-willed and sane enough to undergo the rigorous training and indoctrination required to become a Sanctioned Psyker or Astropath are selected, with a number of these eventually coming into the services of the Inquisition itself. Far more are found unfit for whatever reason, and these are taken from their homes and worlds whether willing or not, bound for Holy Terra and the soul-binding that draws away their life force to feed the ravening maw of the Astronomicon, the artifact upon which the entire Imperium depends for its very survival.

The members of the Ordo Hereticus also monitor the Wars of Faith inspired by the Ecclesiarchy, to ensure they remain within the objectives assigned by the



Ecclesiarch and the other High Lords of Terra. They ensure that the teachings preached by priests of the Imperial Cult remain true to the spirit of the Emperor's will. They regulate the wealth and territory claimed by members of the Ecclesiarchy, to prevent higher members of the institution from gaining more power than is appropriate. Recognizing that no one was infallible and even a High Lord could turn away from the Emperor's Light, the Ordo Hereticus is also called upon to monitor other Imperial organisations for internal threats, including the Adeptus Arbites, the Space Marines, and even the other Ordos of the Inquisition itself. Only the Emperor himself is beyond the gimlet gaze of their jurisdiction. Vandire's "Brides of the Emperor" became the Adepta Sororitas, in keeping with the letter of the law (if not its intent) set down by Sabastian Thor's *Decree Passive* stating the Ecclesiarchy would not maintain an organization of "men under arms." Their mandate and goals in this manner are congruent to that of the Ecclesiarchy, and as a check against the Priesthood's ability to subvert the Imperium's delicate political balance, it was natural that the Adepta Sororitas would become its Chamber Militant.

THE ORDO XENOS – THE THREAT WITHOUT

The beginnings of the Ordo Xenos harken back to a time at the very beginning of the Emperor's Great Crusade when the threat posed by the myriad races populating the greater galaxy had to be ascertained to mitigate their ability to interfere with the Imperium's rapid early expansion. It was not until after the Horus Heresy that this function was integrated into the then-nascent Inquisition, where its mandate continued to be the investigation and study of alien races to eliminate any alien threat to the Imperium they identified. Armed with the best human and alien technology available, extremely knowledgeable about their foe, and filled with hatred for non-human species, the Ordo Xenos can respond

to any alien threat. Their tactics vary depending on the situation and level of alien taint revealed. Where the threat is subtle, they will use guile and stealth, wielding their power as if it was a scalpel used to cut out a cancer.

The Ordo Xenos is well known for either being extremely ponderous or extremely quick to act. A major example of their slowness to act was when the



Tau first made contact with Imperial planetary governors on the eastern fringe of the galaxy, and these aliens' technology was allowed to penetrate all the way to Holy Terra itself. However, at times the Ordo Xenos can truly bring the hammer of the Emperor down on the foul alien, a prime example of which was seen during the Damocles Gulf Crusade in which an Ordo Xenos-headed Imperial Navy battle group penetrated deep into Tau space, although progression slowed to a halt when they reached Dal'yth, one of the core sept worlds of the Tau Empire. It is worth noting that, with the arrival of Hive Fleet Behemoth, the Damocles Crusade was

forced to withdraw from their siege of Dal'yth to attend to other matters.

When the alien menace is great, the Inquisitor can enlist the aid of entire regiments of Imperial Guard and the special contingent of Space Marines drawn from every existing Chapter who are specifically attached to the Ordo Xenos and are known as the Deathwatch. The Deathwatch are squads made up of elite Space Marines from all of the Space Marine Chapters. All Deathwatch members wear black power armor except for one shoulder plate which bears the colors of their original Chapter (so as not to dishonor their power armor's Machine Spirit) and the other is emblazoned with the Icon of the Deathwatch. Certain Chapters make for great Xenohunters, like the Ultramarines with their experience against Tyranids, or the Crimson Fists with their experience against Orks. Deathwatch teams may specialize in defending or attacking any known alien race, including the Tau, Tyranids, Necrons, Orks or even Eldar; it depends upon the experience of the team. When a Battle-Brother leaves the Deathwatch after his term of service to return to his original Chapter, he gains the honor of keeping his armored left arm plate with the symbol of the Deathwatch.

THE ORDO MALLEUS – THE THREAT BEYOND

Originally formed to serve in the role now undertaken in large part by the Ordo Hereticus, it traces its roots to the Horus Heresy. It is the specific task of the Inquisitors and their acolytes of the Ordo Malleus to destroy the physical manifestation of Chaos, Daemons, in the physical universe as well as any other agents of Chaos who threaten the Imperium's worlds. The Ordo Malleus concerns itself with the daemonic threat that faces the Imperium and for thousands of years has waged a covert war for humanity's continued survival against the insidious forces of the Ruinous Powers of Chaos. Besides being the Daemonhunters of the Imperium,

they yet remain a secretive inner order of the Inquisition, controlled by a council of 169 Masters, whose authority extends even to the Master of the Inquisition. The Ordo's organization is divided into Chambers, each controlled by an Inquisitor Lord called a Proctor. The number of Inquisitors in a Chamber can vary from a few score to hundreds. They maintain at their disposal Inquisitorial Storm Troopers, tasked with security of their primary redoubt on Holy Terra as well as the Inquisitions string of Fortresses scattered throughout the galaxy,



some hidden, some extremely well-known and the object of numerous dark legends.

While their Inquisitorial Storm Troopers serve as a highly trained and heavily armed ready security force for the Inquisition as a whole, the Chamber Militant detailed specifically to the Ordo Malleus are the Grey Knights. Their founding is unique of all the Space Marine legions, and like everything else about them, much of their past is shrouded in secrecy. Some say their gene-seed is not based on a Primarch but from the Emperor of Mankind himself, while others postulate that they are created from a cocktail of the eight loyalist Space Marines from the Traitor Legions rumored to have been among those presented to the Emperor by Malcador the Sigilite as part of the Inquisition's founding. Unlike other Space Marines Chapters, they are permanently attached to the Ordo Malleus. While their Fortress Monastery lies buried deep underneath the frigid wastes of Titan, Saturn's moon in the system of Holy Terra, their duties take them throughout the Emperor's Realm. The Grey Knights maintain small, secret redoubts throughout the galaxy, and it can be many decades, if ever, before a Grey Knight returns to that hallowed place where he first donned his aegis helm and took up his nemesis force halberd. Of all Space Marines Chapters, they are the only one made up entirely of psykers. Only they are indoctrinated in the knowledge of the dark secrets of Chaos - they alone completely know of and understand the existence of demons and of their appearance in the real universe, and they alone are best equipped to battle and defeat mankind's most terrible enemy. While other Chapters and Imperium forces have *some* knowledge of daemons and how to fight them, only the Grey Knights are privy to the darkest, deepest secrets that the Ordo Malleus possesses on these creatures and how to defeat them. Despite this immense and terrible burden, in the Space Marines' long history the Grey Knights hold the highest honor of all: Not one Grey Knight has ever turned to Chaos or betrayed the Emperor.

THE ORDOS MINORIS

The three Ordos Majoris serve distinct roles within the Inquisition, but they are not mutually exclusive. It is not unheard of for an Ordo Xenos Inquisitor and his Deathwatch Space Marines kill-team to assist one from the Ordo Hereticus that discovered a group of mutants have collaborated with foul aliens to bolster their weaponry. Inquisitorial Storm Troopers are at times charged to complement the protection and security force of the infamous Blackships, accompanying an Ordo Malleus Inquisitor aboard as she makes her purity checks for the taint of Chaos on worlds along its route. An Ordo Hereticus Inquisitor and his retinue may investigate a well-placed government official suspected of collusion with dark forces drawing Chaos demons against a deployed Grey Knights squad. The Inquisition's shrouded history is replete with such examples.

For recurring threats or missions of grave import, a number of minor Ordos were created, such as the *Ordo Sicarius*, tasked with investigating and controlling the Officio Assassinorum, and the *Ordo Sepulchrum*, one of the smallest of the Ordos Minoris. Formed during the 13th Black Crusade, their particular focus is the relatively new threat presented to the Imperium by the emergence of the Nurgle-spawned Zombie Plague. There are a number of other such minor Ordos, some so deeply secretive they are known only by their members and the Inquisitor Lords that lead them. Individuals and even groups of Inquisitors may be of differing and in some cases even conflicting philosophies and factions with names such as the Thorianists or the Istvaanists, and these allegiances as often as not cross the already ill-defined lines between Ordos. Because of this and the enormous authority each Inquisitor wields, such collaboration and interdependency is the only manner an organization beholden to no-one is able to police itself.

INQUISITION BLACKSHIP 300 Points

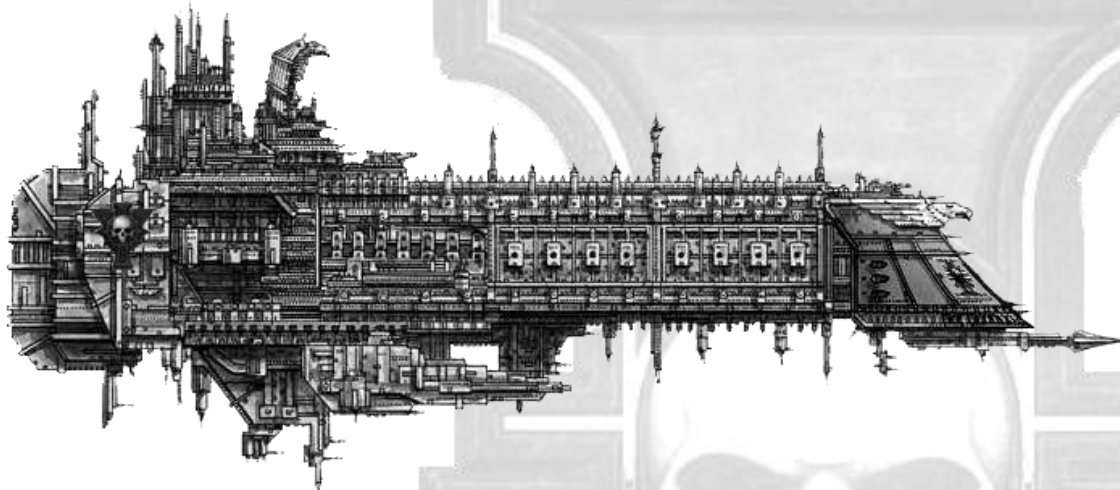

Blackships are typically incredibly ancient vessels, and it is a rare sight to see one of these foreboding starships enter a planetary system. Even rarer is to have one of these built to replace inevitable losses incurred by the very nature of their mission, as vital to the Imperium as it is fraught with danger. Due to the exacting standards and particular specifications required to construct a Blackship, usually this is undertaken nowhere else but at the shipyards of Mars itself, though records indicate a small number were constructed at Kar Durniash and Cypra Mundi.

For all its imposing bulk and the abject fear mere mention of this ship brings, each one is little more than a gigantic transport vessel and high-security prison, albeit fitted with a heavily augmented and carefully-tuned Gellar Field to shroud the beacon-bright imprint so many psykers in such close vicinity would have upon the warp during a Blackship's transit. Additionally, such vessels always embark a large contingent of Untouchables, those cursed with the Pariah gene that appear as psychic nulls to the warp, along with a mission of Adepta Sororitas to keep order aboard the ship and to serve as a final line of defense against enemy boarders. Because of the enormous bounty such a cargo would represent to Chaos or the Dark Eldar, Blackships mount weapons comparable to front-line warships, and it is rare that a Blackship ever plies the void without being under heavy escort.

| TYPE /HITS | SPEED | TURNS | SHIELDS | ARMOR | TURRETS |
|---------------------------|-------|-------------|--------------------|------------|--------------------|
| Battleship/12 | 20cm | 45° | 5 | 6+ prow/5+ | 5 |
| ARMAMENT | | RANGE | FIREPOWER/STRENGTH | | FIRE ARC |
| Port Weapons Battery | | 30cm | 10 | | Left |
| Starboard Weapons Battery | | 30cm | 10 | | Right |
| Dorsal Lance Batteries | | 30cm | 2 | | Left/ Front /Right |
| Prow Torpedoes | | Speed: 30cm | 6 | | Front |

Special Rules: Inquisition Blackships are ponderous vessels and cannot use Come To New Heading special orders. They will never attempt to board an enemy vessel, but their embarked Adepta Sororitas Mission and platoons of Inquisitorial Storm Troopers adds +2 to their roll when defending against a boarding action. Hit and run attacks of any type suffer a -1 modifier. Even when used in fleets with Space Marines, they are not crewed by Space Marines and do not get additional Space Marine benefits.

Gellar Field. The ship is sheathed in an especially powerful Gellar Field to shield the presence of its cargo of untrained psykers from the ravages of the warp. If the ship takes a Shields Collapsed critical hit, roll a D6. On a 4+, the Gellar Field is also damaged and must be repaired before the ship departs the table or disengages, or the ship counts as being destroyed! The Gellar Field is repaired normally as would be any other repairable critical damage, though this does not repair the Shields Collapsed critical.

Special Objective. These vessels are especially rare and fulfill one of the most important missions in all the Imperium. They are as carefully protected by Imperial forces as they are prized by the Emperor's enemies, and it is not uncommon that they in and of themselves will be the object of a battle. This vessel counts as 500 victory points if destroyed. However, it provides the owning player +3 Renown if it survives the battle (+2 Renown if crippled).

Representing and Using an Inquisition Blackship

An Inquisition Blackship can be represented by a Retribution or Adeptus Mechanicus Battleship, which ideally should be painted black! If desired, the rearmost weapon spaces can be filled with lance bits that leave the turrets removed and filled in to represent the cramped decks and compartments at the heart of the ship used for embarking its cargo of untrained psykers bound for Terra.

INQUISITORIAL CRUISER 270 Points

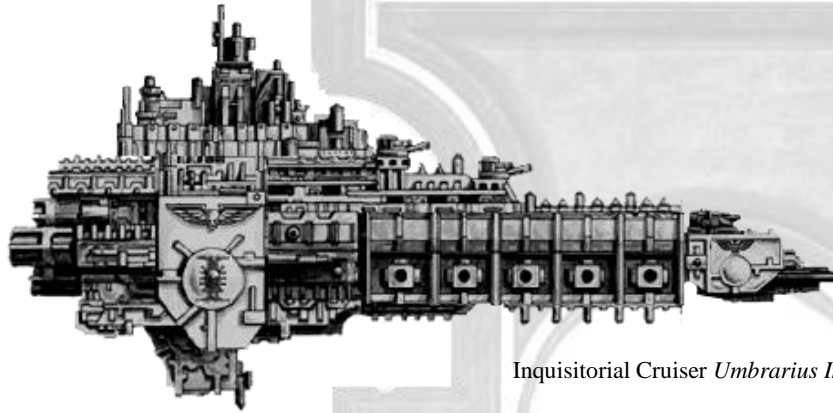

Inquisitorial Cruiser *Umbrarius Inquis*

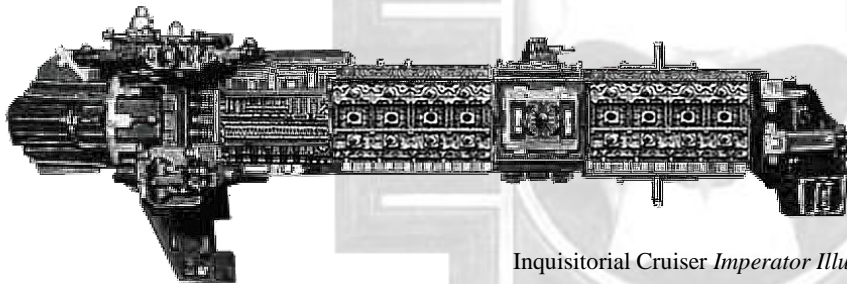

Inquisitorial Cruiser *Imperator Illuminatio*

For all the vast power and authority wielded by an Inquisitor, such august personages will typically rely on guile and subtlety to accomplish their missions. It is most common for them to travel in relative obscurity, relying on little more than the services of a Rogue Trader or passage aboard a passing merchantman to ferry them between worlds. However, when addressing issues of particular urgency, an Inquisitor has the ability to call upon any warship of the Imperial Navy or the Adeptus Astartes, or even the might of an entire fleet or Space Marines Chapter if necessary.

On occasion Inquisitors will utilize one of their own organization's specially-constructed warships. The Inquisition can summon vast resources, and its seat on Terra enables the relatively few vessels they actually possess to call upon all the technological advances and fabrication methods available to the shipwrights and fleets of Mars itself. While a few standard patterns are used by the Inquisition, they are just as often purpose-constructed and optimized for a particular requirement. Inquisitors and their retinues must be prepared for any contingency, and these ships are faster, better armed and better protected than warships typically utilized by the Imperial Navy. While not specifically Blackships per se, Inquisitors are not above referring to them as such precisely because of the awe and fear the mere mention of such vessels incur. Inquisitors will typically utilize these ships only as required for their mission, though some may have such vessels and their crews detailed to them for extended periods of time. Inquisitor Lord Torquemada Cortez is but one of a number of Inquisitor Lords that have an Inquisitorial Cruiser permanently detailed at his or her express disposal.

| TYPE /HITS | SPEED | TURNS | SHIELDS | ARMOR | TURRETS |
|---------------------------|-------|--------------------|--------------------|-------|--------------------|
| Cruiser/8 | 25cm | 45° | 2 | 6+ | 2 |
| ARMAMENT | | RANGE | FIREPOWER/STRENGTH | | FIRE ARC |
| Port Weapons Battery | | 60cm | 8 | | Left |
| Starboard Weapons Battery | | 60cm | 8 | | Right |
| Dorsal Bombardment Cannon | | 30cm | 6 | | Left/ Front /Right |
| Prow Launch Bay | | Thunderhawks: 20cm | 2 | | N/A |

Notes: In addition to the profile listed above, Inquisitorial cruisers follow special rules specific to the Ordo they serve under for the point costs listed on page 7.

Prow Torpedoes. An Inquisitorial cruiser may replace its launch bays for strength-6, Speed: 30cm torpedo tubes for no change in cost. Torpedo tubes may fire normal or boarding torpedoes. If this option is taken, the ship does *not* have to be modified to serve as an Exterminatus vessel in the same manner as Space Marine battle barges, as they are always equipped with virus bombs and cyclotronic warheads as standard. As such, when in position to exterminate a planet, it may do so on a roll of 3+ instead of 4+. Inquisitorial cruisers do not have access to Thunderhawk Annihilators, even if included in a Space marine Crusade Fleet.

Dorsal Lances. An Inquisitorial barge may replace its dorsal bombardment cannon for strength-2, range: 45cm lances firing Left/ Front/ Right for +15 points.

GREY KNIGHTS STRIKE CRUISER 165 points

Like other Space Marine Chapters, the Grey Knights' primary mode of transportation is the strike cruiser class of Imperial starship that is exclusive to the Chapters of the Adeptus Astartes. However, the Grey Knights' starships are specially modified in several ways. One is the hexagrammic and anti-daemonic wards that are built into the entire ship from bridge to landing struts and every bulkhead in between, similar to those that are placed under the skin of the Grey Knights themselves. These wards lend the ship added protection from the forces of Chaos. Also, the Grey Knights' strike cruisers are

constructed with significantly more advanced armour than the starships of other Chapters. This is to allow them to close with more powerful foes and reach their destination safely, since the Grey Knights must fight more powerful enemies than the standard Adeptus Astartes Chapters. Finally, the landing and drop pod bays are enlarged to be able to deploy larger numbers of Marines faster. The crew of Grey Knights strike cruisers are all strictly mind-wiped to prevent the possible taint of Chaos corruption, and are given a key word which will kill all the crew members on a Grey Knights strike cruiser and

destroy the ship should it fall into the hands of the forces of Chaos.

The modifications to the Grey Knights' ships are made possible by two factors. The first is their fortress monastery's location on Titan, a moon of Saturn and in close proximity to Mars, the greatest Forge World in the Imperium of Man. This provides access to technology, materials refinement and fabrication techniques that were forgotten or are impossible to replicate anywhere else in the Imperium, which also explains the high quality of all Grey Knights equipment. Secondly, these efforts are made possible by the prodigious resources the Ordo Malleus provides the Grey Knights due to their position as its Chamber Militant.

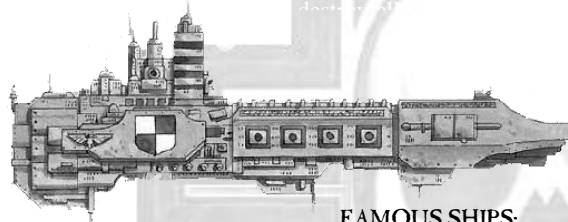

FAMOUS SHIPS:
Fors Clavigera *Imperator Gloriam* *Mea Virtus*

| TYPE /HITS | SPEED | TURNS | SHIELDS | ARMOR | TURRETS |
|---------------------------|-------|--------------------|--------------------|-------|--------------------|
| Cruiser/6 | 25cm | 90° | 2 | 6+ | 2 |
| ARMAMENT | | RANGE | FIREPOWER/STRENGTH | | FIRE ARC |
| Port Weapons Battery | | 30cm | 4 | | Left |
| Starboard Weapons Battery | | 30cm | 4 | | Right |
| Prow Bombardment Cannon | | 30cm | 3 | | Left/ Front /Right |
| Prow Launch Bay | | Thunderhawks: 20cm | 2 | | N/A |

Notes: Strike Cruisers of the Adeptus Astartes represent the apex of Imperial warship design and construction, and in no case is this more apparent than the vessels fabricated by Mars itself for the exclusive use by the Grey Knights. These vessels roll +5D6 when on *All Ahead Full* special orders. Grey Knights strike cruisers do not have access to Thunderhawk Annihilators, even when used with a Space Marine Crusade fleet list. Grey Knights are fearsome warriors even among other Space Marines; they may re-roll any boarding action result (the second roll stands).

Replace launch bays. Up to half of the Grey Knights strike cruisers in a fleet may replace their launch bays for strength-6, Speed: 30cm torpedo tubes or a firepower-5, range 30cm (front arc only) bombardment cannon battery for no change in cost, in any mix desired. Torpedo tubes may fire normal or boarding torpedoes.

GREY KNIGHTS BATTLE BARGE – 440 Points

A fleet led by an Ordo Malleus Inquisitor including at least 1000 points of Inquisition vessels and Grey Knights strike cruisers may include a single Grey Knights battlebarge. This ship follows the standard profile for battle barges in all respects. Additionally they benefit from all Grey Knights special rules listed here and on p.59.

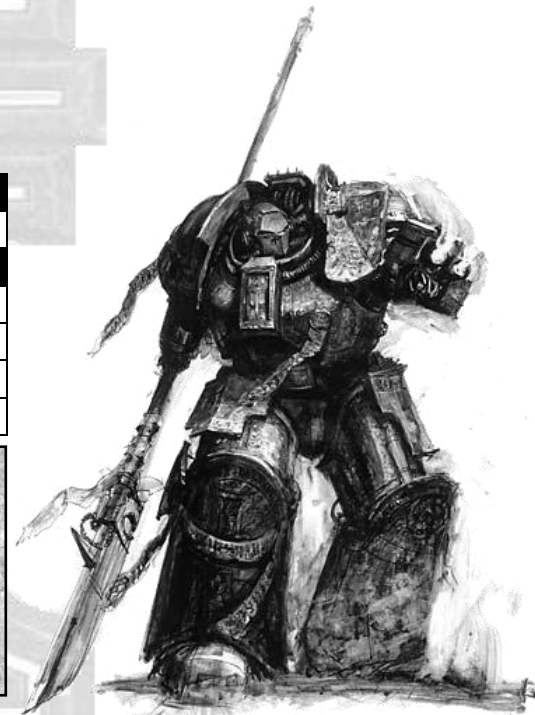

THE EMPEROR'S INQUISITION IN BATTLEFLEET GOTHIC

FLEET COMMANDER

0-1 Inquisitor Lord

Any Imperial or Space Marine fleet 750 points or greater may be led by an Inquisitor Lord, who must be placed on an Inquisition Blackship if one is present, or on the most expensive ship in the fleet if one is not. They must be aboard an Inquisitorial Cruiser if it is included in the fleet, even if it is not the most expensive ship or a Blackship is also present.

Inquisitor Lord (Ld9) 75 points

An Inquisitor Lord gets one re-roll, which may be used for any ship in the fleet. A second re-roll can be purchased for +25 points.

CAPITAL SHIPS

Any Imperial or Space Marine fleet may include a single Inquisitorial Cruiser in the fleet, which takes the place of a battlecruiser or strike cruiser in the fleet. If an Inquisitor Lord is leading the fleet, up to one Grey Knights Strike Cruiser may be taken for every 500 points in the fleet. A Space Marine fleet led by an Inquisitor Lord may rely heavily or even exclusively on Grey Knights Strike Cruisers if desired, in which case a single Grey Knights battlebarge may be taken. The fleet may also include a single Blackship, which as a special vessel does not count toward or against other ship limits in the fleet.

(0-1) Grey Knights Battlebarge 440 points

(0-1) Inquisition Blackship 300 points

(0-1) Inquisitorial Cruiser 270 points

Grey Knights Strike Cruiser 165 points

ESCORTS

Squadrons of 2-6 escorts may be taken from the Imperial, Space Marine or Adeptus Mechanicus fleet lists, as appropriate, in any mix desired following the normal rules and restrictions for those fleet lists. For example, if an Inquisitor and his cruiser are leading an Imperial Navy fleet, only Imperial Navy escorts may be taken.

INQUISITORS OF THE ORDOS

If desired, Inquisitorial cruisers may gain special characteristics, depending upon the Ordo the Inquisitor leading the fleet is affiliated with. This will

typically (though not necessarily) be related to the enemy the fleet is facing. For example, an Ordo Hereticus Inquisitor may lead a fleet to perform Exterminatus on a planet subsumed by a witch-cult, an Ordo Xenos Inquisitor and her kill-team may be sent to clear a derelict Space Hulk of a Tyranid infestation, etc. However, these shadowy agents of the Imperium are only called upon in dire need, usually only when a threat to the Imperium has gained a significant foothold in a system, or a war threatens to turn for the worse. The cost below is added to that of the Inquisitor Lord, and its benefits apply to the ship he/she is embarked upon.

Ordo Hereticus Inquisitor Lord +25 points

A vessel embarking an Ordo Hereticus Inquisitor Lord is accompanied by a mission of Adepta Sororitas and/or platoons of Inquisitorial Storm Troopers that serve as his or her personal bodyguard and assault force. The ship adds +1 to its leadership (max. 10) and +2 to its roll during a boarding action. Hit and Run attacks from this ship add +1 to their roll, and such attacks against this ship subtract -1 from their roll. If a Blackship is used as an Exterminatus vessel, a Hereticus Inquisitor must lead it.

Ordo Xenos Inquisitor Lord +30 points

A vessel embarking an Ordo Hereticus Inquisitor Lord is accompanied by a Deathwatch kill-team that serves as his or her personal bodyguard and assault force. The ship adds +1 to its leadership (max. 10) and +2 to its roll during a boarding action against alien vessels, during which Xenos ships subtract -1 from their roll. Hit and Run attacks from this ship add +1 to their roll, and such attacks against this ship subtract -1 from their roll. Rolled saves by holofields, shadowfields or any similar rule against a boarding action or hit and run attack succeed on a 3+ instead of a 2+. Additionally, the vessel upon which the Inquisitor Lord is embarked may roll once against the following table and apply it to the ship, or the refit may be selected for an additional +5 points.

1. **Long Range Sensors:** The vessel adds +1 to its base leadership (max of Ld10).
2. **Targeting Matrix:** The vessel counts all targets

as closing when using the gunnery table within 30cm and ignores all right-shift modifiers for shooting greater than 30cm.

3. **Advanced Shielding:** The vessel increases the strength of its shields by +1.
4. **Ship Defense Grid:** The vessel increases the strength of its turrets by +1.
5. **Advanced Drive Technology:** The vessel adds +5cm to its speed as well as +1D6 when undergoing *All Ahead Full* special orders.
6. **Gravitic Thrusters:** The vessel doubles the maximum rate of its normal turn.

An Ordo Xenos Inquisitor will only be called when an alien threat significantly exceeds a given Sector Stabilis mandate. The enemy Xenos fleet adds D6x50 points of escort vessels to its fleet for free.

Ordo Malleus Inquisitor Lord +25 points

A vessel embarking an Ordo Malleus Inquisitor Lord is accompanied by several squads of Grey Knights Space Marines that serves as his or her personal bodyguard and assault force. The ship adds +1 to its leadership (max. 10) and +2 to its roll during a boarding action. Hit and Run attacks from this ship add +1 to their roll, and such attacks against this ship subtract -1 from their roll. This ship or one Grey Knights vessel may board a Grey Knights terminator boarding party for +50 points. Every Grey Knights strike cruiser in the fleet may embark an Honor Guard for +10 points. This ship and every Grey Knights strike cruiser in the fleet mounts hexagrammic wards throughout its hull and ignores any Chaos marks or Daemanship effects affecting leadership or boarding actions. Marks of Slaanesh do not affect the leadership of this vessel, Marks of Khorne do not double boarding values against this ship, etc. Rules for Chaos Space Marines still apply normally, and any other special rules and effects such as the Forces of Chaos listed on p.158 of the Rulebook remain unaffected.

An Ordo Malleus Inquisitor will only be called when intense demonic activity threatens to overrun an entire Sector. The enemy Chaos fleet may add one Mark of Chaos or upgrade a cruiser to a Daemanship at no cost, and may also do so again as many times as there are Grey Knights strike cruisers in the fleet.



USING VESSELS OF THE INQUISITION

Throughout its long and shrouded history, the Inquisition has used its authority to requisition the construction of various cruisers from the Adeptus Mechanicus. The purposes of some are clearly evident, such as special-designed warships to fulfill the needs of the Ordo Xenos, while others were constructed for missions and purposes more obscure in nature. An inquisitor may be content to use such vessels to merely accompany a fleet under the command of another authority, or they may even travel in obscurity aboard a Rogue Trader vessel or merchant transport. A single Inquisitorial cruiser led by an Inquisitor can be taken as reserves by any Imperial Navy, Space Marine or Mechanicus fleet, or an Inquisitor and his retinue may be embarked on a single Rogue Trader cruiser.

An Inquisitor Lord may called forth to lead a fleet at times of great duress, during which his or her word is law and authority is absolute. However, even unquestioned loyalty may come in many shades, and such vagaries are only magnified by the authority and power one wields. Even one as august a personage as an Inquisitor will have his thoughts and goals colored by his training, experiences and philosophy. While there are many factions and allegiances within the Inquisition, only how an Inquisitor's affiliation leans between the Puritans and the Radicals can visibly affect his or her decisions at the scale of Battlefleet Gothic.

Ordnance and Upgrades

If an Imperial Navy or Adeptus Mechanicus ship embarking an Inquisitor is equipped with launch bays, it must replace its attack craft with Thunderhawks, with its launch bay strength divided in half. Ships with torpedo tubes are armed with ordinary and

boarding torpedoes, and for no cost or modification can also act as Exterminatus vessels.

Attack Rating

An Imperial Navy or Adeptus Mechanicus fleet led by an Inquisitor Lord has an attack rating of 2. A Space Marine fleet led by an Inquisitor Lord has an attack rating of 3 unless a Blackship is accompanying the fleet, in which case its attack rating is 2.

Scenarios

Scenarios may be rolled normally in any agreed-upon fashion. If a Convoy Run scenario is rolled and the defending fleet list includes an Inquisition Blackship, this vessel may be used as the objective in the same manner as a transport convoy, counting as eight transports for purposes of deciding escorting forces. A single Inquisitorial Cruiser may be included as part of the escorting fleet if desired and the points are available, keeping in mind that the point value of the Blackship counts against the escorting fleet!

Sub-Plots

Inquisitors are almost always in pursuit of some higher objective that may be obscured by the current conflict at-hand. In addition to any sub-plots rolled normally, the fleet led by an Inquisitor must take a Secret Ploys sub-plot rolled randomly from p.84 of the Battlefleet Gothic Rulebook.

RESERVES AND ALLIES

Any one of the Imperial Navy, Adeptus Mechanicus and Space Marine fleets led by an Inquisitor may always take ships from the other two as reserves in the normal manner, though Space Marine fleet may only take vessels from the Imperial Navy or Adeptus Mechanicus fleet lists as reserves. A single Rogue Trader cruiser may also be taken. If taken, a Rogue Trader escort squadron may accompany it, but Xenos vessels may not be used. Space Marine Chapters are fiercely independent and will only grudgingly submit to having their leadership usurped by an Inquisitor Lord, regardless of his renown. While a Space Marine Captain or Fleet Master may agree to parley at an Inquisitor's side, they will not

countenance adding insult to injury by actively serving alongside Xenos or potentially renegade vessels of any stripe!

An Imperial Navy or Adeptus Mechanicus fleet led by an Inquisitor that does not include Space Marine vessels may take reserves and/or allies in the following manner.

Ordo Hereticus Inquisitors

By their nature, this Ordo tends to be made up the most conservative and Puritan members of the Inquisition. Rogue Traders will be regarded with particular suspicion, though a single Rogue Trader and its attendant escorts may accompany the fleet.

Ordo Xenos Inquisitors

While Inquisitors of this Ordo know they must be fully cognizant of Xenos races in order to defeat them, radical Inquisitors of this Ordo that follow the philosophies of the Istvaanists and Xeno Hybrists actively cultivate accommodation with aliens and seek their technology for the Imperium's benefit. For no change in their cost, a fleet led by an Ordo Xenos Inquisitor may be accompanied by a single Demiurg capital ship, Corsair Eldar cruiser or Tau cruiser. If taken, the Inquisitor's ship loses its Deathwatch contingent along with their leadership and boarding value bonus.

Ordo Malleus Inquisitors

Inquisitors of this Ordo are more knowledgeable of the dire threat Chaos poses to all of humanity than virtually anyone in the Imperium. Some radical Inquisitors of this Ordo come to believe they can actually control this to an extent, turning Chaos against itself to humanity's benefit. For no change in their cost, a fleet led by an Ordo Malleus Inquisitor may take as reserves any Chaos ship listed in the Bastion Fleet List on p.29 of Armada. These vessels are free of the "Strange Happenings" special rule as long as the Inquisitor's ship remains in play, but the fleet may not take any Grey Knights vessels, and the Inquisitor's ship loses its Grey Knights contingent along with their leadership, boarding value and other bonuses. Likewise, Chaos opponents gain no benefits, as the Grey Knights are absent.

ADEPTUS ASTARTES

DOMINIONS OF THE SPACE MARINES, GUARDIANS OF MANKIND



When Roboute Guilliman, Primarch of the Ultramarines, set about the long and arduous task of preparing the Codex Astartes, the role of space vessels amongst the Adeptus Astartes proved a particular sticking point. For an Imperium still reeling from internecine Hersey that almost tore it apart, the division of power was a vitally important consideration. One of the most extreme options on offer, it was ventured by some that the Space Marines should be denied any vessels at all, barring intra-system transports for movement between homeworlds and attendant moons. Corax, among others, protested strongly that in fact had the Space Marines been better equipped with fleets of their own, his own legion might not have been so horrendously decimated when trapped on Istvaan V by Horus and the newly revealed traitors. Instead, a compromise was reached which limited the Space Marines to vessels whose primary role was that of transport, delivery and suppression designed to facilitate planetary assault. Only the smallest of vessels would be permitted to act exclusively as gunships, with the larger strike cruisers and battlebarges remaining predominately as aids to invasion, ensuring the Space

Marines would never present a threat to the Imperial navy proper. Inevitably, the wrangling over interpretation of a ship's "primary role" leads to some Chapters possessing rather more versatile fleets than the Imperial Navy is entirely comfortable with.

Unlike the vessels of the Imperial Navy, a Space marine ship has a relatively small crew. A Space Marine is far too valuable to waste on manning a gun or watching a surveyor screen, and so only the officers aboard a vessel are likely to be Space Marines, as well as the few Techmarines who oversee the engines and perform other mechanical duties. Almost all the ship's systems are run and monitored by servitors, half-human cyborgs who are wired into the vessel's weapons, engines and communications apparatus. There are also a few hundred of the Chapter's serfs to attend to other duties, such as routine cleaning and maintenance, serving the Space Marines during meal times and other such honored tasks. These serfs come from the Chapter's home planet or the enclave they protect, many of them Novitiate or applicants who have failed some part of the recruiting or training process. These serfs are fanatically loyal to their superhuman masters and are indoctrinated into many of the lesser orders of the Chapter's Cult. Although human, they still benefit from remarkable training and access to weaponry superior to that usually found aboard a naval vessel, making them a fearsome prospect in a boarding action – even without the support of their genetically modified lords.

FLEET ORGANIZATION

Usually, one of the Chapter's Captains will be appointed Master of the Fleet with overall responsibility for the Chapter's entire fleet. This will place at his disposal all the pilots, gunnery officers, command crews and navigators in the Chapter. These additional crewmen will not join the Master of

the Fleet's own company, for they themselves are not Space Marines. Most Chapters include several Cults dedicated to the Fleet or to the vessels within it, and it is the rarefied honor of admission to these Cults which the serfs aspire to when recruited into the fleet, for despite all their specialization they will always remain subservient to their Space Marine masters, no matter how much the fleet might actually rely upon them. While these serfs make up the vast bulk of crews aboard Space Marine vessels, the Master of the Fleet also has a number of Space Marines under his command, who act as high-ranking officers aboard the fleet's capital ships, providing captains for individual vessels, leading specialized boarding parties, or otherwise overseeing the dedicated serfs who provide the bulk of a vessel's manpower.

The exact organization of those Space Marines tasked with crewing the fleet varies from Chapter to Chapter. In some cases, it will be the Master of the Fleet's own company that provides these Marines, with each of his veteran captains acting as captain to a different vessel within the fleet while their own squad members each man a different vital area within that same vessel. In other cases, squads from different companies within the Chapter may be charged with manning the fleet, serving under the command of the Master of the Fleet in the same way that a Space Marine battleforce may be made up of squads drawn from several companies across the Chapter under the command of a single, nominated force commander. At an absolute minimum, a Master of the Fleet typically needs eighty to a Thunderhawks and its landing craft, and most Chapters have measures in place to ensure that a standing force of this size is permanently available to the Master of the Fleet.

As with all specialized roles which a Space Marine might be honoured, serving in the fleet brings with it a variety of different titles and ranks. While the Master of the Fleet retains overall control of the

entire fleet, Space Marine Chapters frequently find themselves dispersed among several warzones all over the galaxy, and so the command of individual fleets or even lone vessels frequently falls to individual Captains. In this manner, a Space Marine force commander may well find that he is charged with command of both the battleforce and the transporting fleet, earning him additional honorifics, such as Regent of the Fleet, Commander at Sail and so on. A Marine's heraldry and personal armor markings may well bear emblems of his service within the fleet, additional honors and titles gained there, or other emblems signifying their role within the fleet.

SPACE MARINE SPECIAL RULES

In all cases, the following rules are in addition to those listed on pp.20-27 and 30 of Armada.

Thunderhawk Annihilator

The Thunderhawk Annihilator is a specialized gunship employed only by crusading Chapters. Forsaking its transport capability in favor of a powerful Annihilator cannon, it provides crusading Chapters with the kind of thunderous firepower normally provided by the bombers of the Imperial Navy or the Battle Titans of the Adeptus Mechanicus.

Thunderhawk Annihilators combine the abilities of bombers and fighters, and they move like any other attack craft with a speed of 20cm. A Thunderhawk counter that is intercepted by enemy fighters or moves onto an enemy ordnance marker removes the enemy marker exactly the same way fighters would. However, they are extremely resilient and follow all special rules for Thunderhawks described on p.21 of Armada.

When a Thunderhawk Annihilator comes in contact with an enemy ship's base, they attack it like bombers as described for bombers on p.30 of the Rulebook, even if they have used their resilience to

remain in play. Once they complete their attack, they are removed normally. Thunderhawk Annihilators cannot be used as assault boats.

Drop Pods

All Space Marine capital ships are equipped with drop pods. These add nothing to their profile and are not treated as ordnance in any respect. Drop pods enable Space Marine capital ships to quickly deploy Space Marines to the surface and impart +2 assault points for each capital ship during a planetary assault instead of +1.

Honor Guard

Most Chapters maintain special bodies of honored Space Marines with extraordinary experience, given over to form the personal retinue of company captains, great heroes within the Chapter or even the Chapter Master himself. Once per turn you may use the Honor Guard, if your fleet list includes them. All the normal rules for teleport attacks apply, except that they may be used in addition to a normal teleport attack that turn. The player may roll two dice and choose which one to use as the result, including the normal +1 bonus for being Space Marines.

Terminator Boarding Parties

Taken from the elite First Company and wearing the heaviest armor known to man, Terminators are the greatest ship-to-ship fighters in the galaxy. Once per turn a vessel equipped with Terminator boarding parties may use them when conducting a hit and run teleport attack. They roll two dice for its hit and run attack and apply both results, including the normal +1 bonus for being Space Marines. Terminators may be used in addition to a normal teleport attack that turn.



SPACE MARINES IN BATTLEFLEET GOTHIC

In addition to the ship classes described on pp.22-25 of Armada, some Space Marine fleets may make use of the following vessels.

SPACE MARINE FORTRESS - MONESTARY 1,000 Points

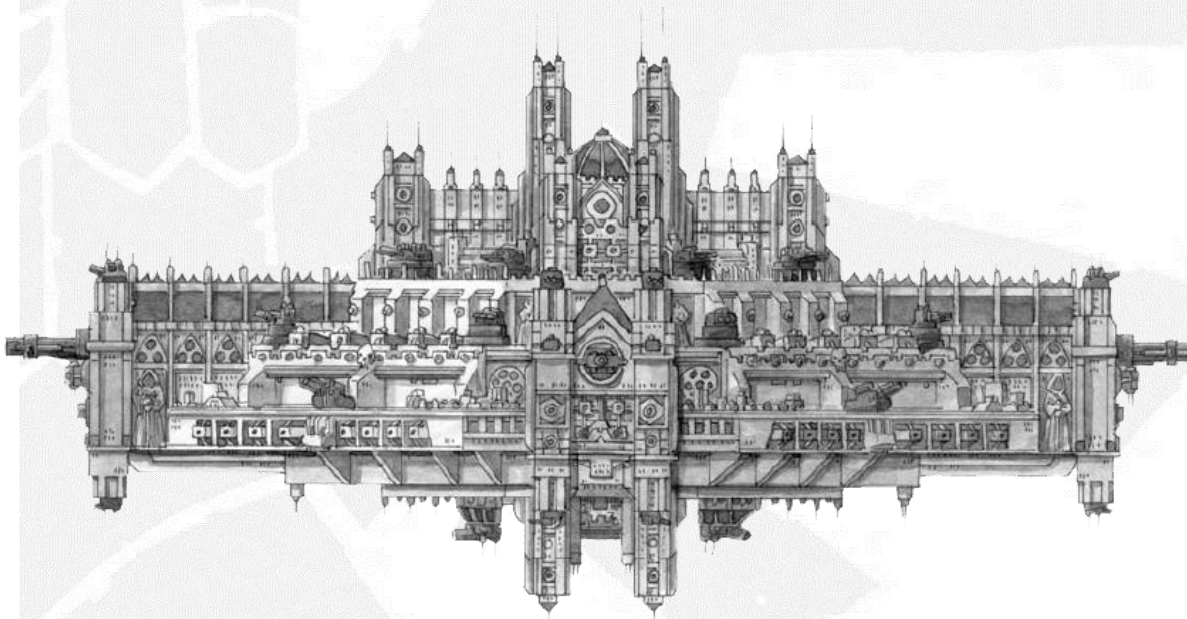

Some Chapters possess no homeworld at all, and instead operate from mobile space fortresses. These gigantic craft contain sufficient accommodation, workshops, hangars, training areas and dock facilities for the entire Chapter and operate as a semi-mobile base for Chapter operations. While they may take any number of forms, fortress-monasteries are immensely powerful, with firepower equivalent to that of the mighty Ramilies Star Fortress in many respects. Additionally, they are not only mobile but warp-capable, and it is not unknown for some Space Marine Chapters to actually utilize a suitably modified Ramilies Star Fortress allocated to them for this express purpose. No Chapter possesses more than a single fortress, and as the base of operations for the entire Chapter they are guarded just as ferociously as a homeworld would be.

Fortress-Monastery special rules

In all cases, a Fortress-Monastery follows all rules for the Ramilies Star Fortress detailed on pp.31-34 except as specifically outlined in these rules.

Special Orders, Split Orders and Leadership

Fortress-monasteries can undertake special orders in the same manner as a Ramilies Star Fortress. They have a base leadership of 10; they are the home to the command staff of an entire Space marine Chapter, after all! It may also purchase re-rolls at the cost listed in its fleet list. These re-rolls are usable only by the fortress-monastery itself. Fleet Commanders may be placed aboard a fortress, in which case their own leadership value is used (even if less!). If used in this manner, re-rolls purchased by the fortress-monastery are added to the commander's own re-rolls and can be used by the entire fleet. Different quadrants may use different special orders in the same manner as a Ramilies Star Fortress, and the Basilica likewise can be under multiple special orders at the same time.

| TYPE /HITS | SPEED | TURNS | SHIELDS | ARMOR | TURRETS |
|-----------------------|--------------------|--------------|--------------------|-------|--------------|
| Defense/12 (quadrant) | 0cm | 0° | 4 (quadrant) | 6+ | 4 (quadrant) |
| ARMAMENT | | RANGE | FIREPOWER/STRENGTH | | FIRE ARC |
| QUADRANT WEAPONS | | | | | |
| Weapons Battery | 60cm | 18 | Quadrant | | |
| Lance Battery | 45cm | 3 | Quadrant | | |
| Launch Bays | Thunderhawks: 20cm | 3 Squadrons* | Quadrant | | |
| BASILICA WEAPONS | | | | | |
| Weapons Battery | 60cm | 8 | All Round | | |
| Torpedo Silos | Speed: 30cm | 9 | All Round | | |

*See the special rules for Fortress-monastery launch limitations concerning Thunderhawks

Movement

Before the game starts, the owning player can decide if the fortress-monastery will rotate or not. Once decided, it cannot be changed throughout the game. If it is decided that it will rotate, it does so for 45 degrees once per game turn (no more or less) at the beginning of the owning players movement phase. If it rotates, it will always rotate in the same direction. The Ramilies otherwise does not move in any way during the course of the game, it still counts as defenses, and this movement does not alter nor can it be altered by any command checks or special orders it makes. If the owning player decides the fortress-monastery will rotate, then it cannot have ships dock with it for the duration of the game.

Quadrants

Quadrants function the same way they do for Ramilies Star Fortresses in all respects, including receiving damage normally and against Nova Cannon templates, shooting and ordnance attacks. Quadrants are treated individually in regards to critical damage, hit and run attacks, becoming crippled, and when reduced to zero damage.

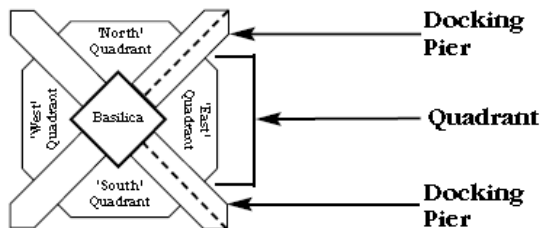

Docking

If the fortress-monastery is not rotating at the start of the battle, ships in close proximity with the fortress-monastery may dock with it as described in the rules for a Ramilies star fortress and may use a Burn Retros command check for free to do so. Any ship docked with it gets an extra four dice to repair critical damage at the end of every turn it is docked

to the fortress-monastery. If it remains docked for two full turns without being braced, it automatically reloads ordnance and does not need to pass a Reload Ordnance command check to do so.

Shields and Blast Markers

Each quadrant has its own shields; when blast markers are placed, put them in contact with the appropriate edge of the fortress-monastery's base. In the end phase, D6 blast markers are removed from the entire model, not just from each quadrant. Because the four quadrants are essentially in contact with each other, blast markers in contact with the base effect the quadrant taking fire and the two adjacent quadrants as well. If the fortress-monastery is rotating, blast markers not removed remain in place when the Ramilies rotates and affect whatever quadrant they are in contact with at the end of its movement.

Hit-and-Run Raiders

Hit and run raids are resolved only against the quadrant they are directed at and will not affect other quadrants. Remember that the fortress-monastery is a Space Marine installation, and as such hit-and-run attacks will deduct -1 from their dice roll.

Teleport Attacks

Fortress-monasteries contain numerous teleport chambers, both for dispatching troops to other vessels in the fleet and delivering them into combat, be it on a nearby planet or as a devastating hit and run attack against enemy vessels. Each quadrant not crippled allows the fortress-monastery to launch one teleport hit and run attack in the normal manner, with all teleport attacks benefiting from a +1 bonus for being Space Marines. In addition, one of the teleport attacks made by the fortress can be conducted by Terminator boarding parties. This is included in the fortress-monastery's point cost and does not have to be purchased extra. This extra attack can be made once per turn.

Boarding Actions

At times, an entire Space Marine Chapter may be found aboard a fortress-monastery, along with an untold number of their highly-trained serfs and retainers. Attempting to board one of them would be equivalent to trying to capture an entire city or even a small planet – tens of thousands of troops would be needed. Only Space Hulks may attempt to board fortress monasteries, since only they can possibly carry enough troops. Even then, the fortress-monastery has a +2 modifier for being Space Marines before any other modifiers are taken into account.

Damage Control and Catastrophic Damage

Damage control is also undertaken individually, as is for a Ramilies Star Fortress. The fortress-monastery is only destroyed when all four quadrants are reduced to zero damage, at which time the owning player rolls against the catastrophic damage table on p. 34 of Armada.

Thunderhawks

While a fortress-monastery has sufficient launch bays to unleash great swarms of Thunderhawks, these large and complex gunships are in limited supply and are not necessarily all based on the fortress-monastery at any given time, having been dispatched to other vessels within the fleet. It does however provide a base for them to home back to should their original carriers be lost. A Space Marine fleet may always count its launch limit as equal to the surviving bays on the fortress-monastery or in the normal manner, whichever is greater. This is instead of the "double remaining launch bays" rule of a Ramilies Star Fortress, and it may only launch as many Thunderhawks as needed to bring the fleet up to its launch limit. If the fleet has a launch limit of 17 and 12 markers are already in play, the Fortress-monastery can only launch 5 more Thunderhawk markers from the fortress-monastery or from other ships in the fleet.

VENERABLE BATTLE BARGE Points: Varies

A battle barge is not a class of vessel, but rather it is the name given to any vessel configured to fulfill the role of battle barge. Because of this, it is theoretically possible for any large capital ship to fulfill this role, although the battle barges specially designed for the Space Marines by the Adeptus Mechanicus are the most common example. However, some older Chapters, particularly those dating back to the First Founding, maintain much more ancient and revered vessels dating back to a time when the Adeptus Astartes and the Imperial Navy were more closely united than they now are and commonly employed reconfigured Navy vessels as battle barges. Such vessels are completely unique; indeed, some of them were later used as the basis for new Imperial Navy ship classes, and as such are greatly venerated by the Space Marines.

Some Chapters rely on truly unique vessels imparted upon them for a specific role or to meet some dire threat. Others simply retain vessels they received millennia ago or gained through other means. The Space Wolves, a traditionally minded Chapter, is more immersed in the customs of its homeworld of Fenris than most Chapters and has access to only the most rudimentary of shipyards, and they are perhaps the best known example of this, relying as they do

on an Emperor-class battleship to fulfill the role of battle barge.

Choosing a Battle Barge

In addition to their fleet list, any Space Marine fleet may include a single Venerable battle barge (meaning only one!), which may be any Imperial or Chaos battleship, grand cruiser, battlecruiser or heavy cruiser (painted appropriately of course!). This replaces one of the battle barges allowed in the fleet. The normal cost must be paid for the ship, plus an additional +35 points for the cost of the Space Marine crew. This vessel represents an ancient, revered icon or a vessel granted with special dispensation. It is worth 100% victory points if crippled or 150% victory points if destroyed.

A Venerable battle barge benefits from all the Space Marine special rules, but since it is already heavily reconfigured to make it into a battle barge, it may not be given any of the optional refits or upgrades listed in its profile – it must be used exactly as is, in its basic form. For example, a Mars battlecruiser taken as a Venerable battle barge may not be given a salvaged targeting matrix for +15 points and can only earn such a refit in the course of a campaign normally. The only exceptions to this are the special refits that the Space Marines themselves make to

their battle barges, as follows.

Launch Bays and Thunderhawks

Any launch bays on a Venerable battle barge have their launch capacity halved (rounding up). For example, an Imperial Mars battlecruiser with two launch bays each side is reduced to one each side, and a Chaos Styx heavy cruiser with three launch bays on each side is reduced to two each side. The launch bays are configured to carry Thunderhawks following the rules detailed beforehand and on p.21 of Armada, and they cannot be used to launch any other form of attack craft. This is a compulsory refit that applies to all Venerable battle barges equipped with launch bays. A Venerable battle barge not equipped with launch bays cannot take Thunderhawks.

Prow Weapons and Boarding Torpedoes

Any Venerable battle barge equipped with a prow weapon (regardless of what it is) may if desired replace it with strength-6 torpedo tubes (speed: 30cm) for no change in cost. As with all Space Marine vessels, these tubes may also be used to launch boarding torpedoes. These boarding torpedoes are manned by Space Marines and get a +1 to their hit and run attacks when they hit an enemy ship.



VENERABLE BATTLE BARGE SEDITIO OPPRIMERE 450 Points

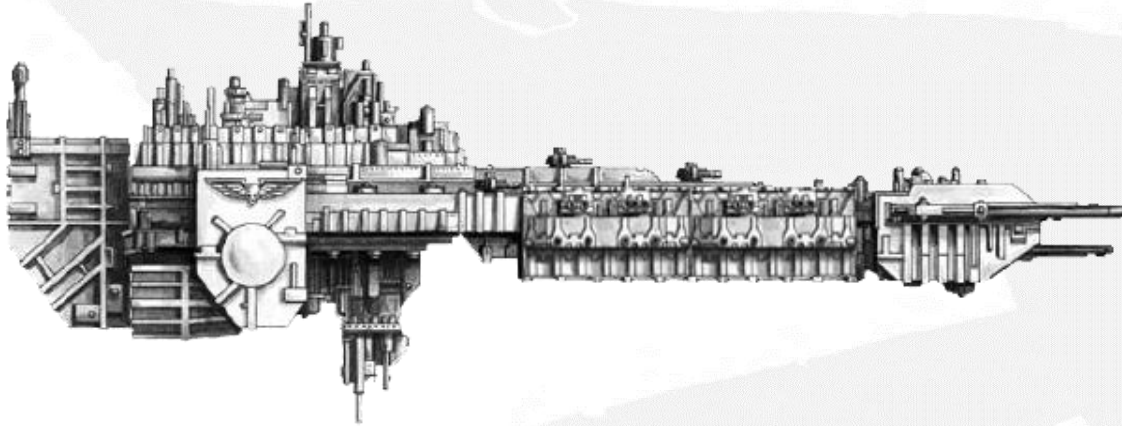

First recognized for the threat it was in 745.M41, Hive Fleet Behemoth ravaged the Imperial worlds of Ultima Segmentum until it began encroaching upon the Ultramar sub-sector, dominion of the Ultramarines Chapter. The *Seditio Opprimere* was reduced to a near hulk at the Battle of Prandium as the Tyranids reduced to a barren wasteland what was once a fertile and lush garden world, the “Jewel of Ultramar.” Despite the great Imperial victory defeating Behemoth in the Ultramar home system above the rings of Circe, the Imperial Navy faced staggering losses, and the Ultramarines faced little resistance when the Mechanicus Adepts of Calth rebuilt it as a powerful gunship with the weapons fit and defenses to burn through the miasma of spore clouds when fighting the Tyranids. Designing such improvements into the vessel proved difficult, and some launch bay capacity had to be sacrificed for the additional magma bomb magazines and energy conduits for its upgraded defenses.

Representing the Seditio Opprimere

The Seditio Opprimere represents a venerable battle barge as-is and does not need to pay +35 points for having Space Marines. It can easily be modeled by constructing a Space Marine battle barge normally but substituting two lance batteries from the Imperial plastic cruiser sprue on each side instead of the gun decks that come with the model.

| TYPE /HITS | SPEED | TURNS | SHIELDS | ARMOR | TURRETS |
|---------------------------|-------|--------------------|--------------------|-------|--------------------|
| Battleship/12 | 20cm | 45° | 4 | 6+ | 4 |
| ARMAMENT | | RANGE | FIREPOWER/STRENGTH | | FIRE ARC |
| Port Bombardment Cannon | | 30cm | 8 | | Left |
| St'bd Bombardment Cannon | | 30cm | 8 | | Right |
| Dorsal Bombardment Cannon | | 30cm | 8 | | Left/ Front /Right |
| Prow Launch Bay | | Thunderhawks: 20cm | 2 | | N/A |
| Prow Torpedoes | | Speed: 30cm | 6 | | Front |

Special Rules: The *Seditio Opprimere* is a ponderous vessel and cannot use Come To New Heading special orders.

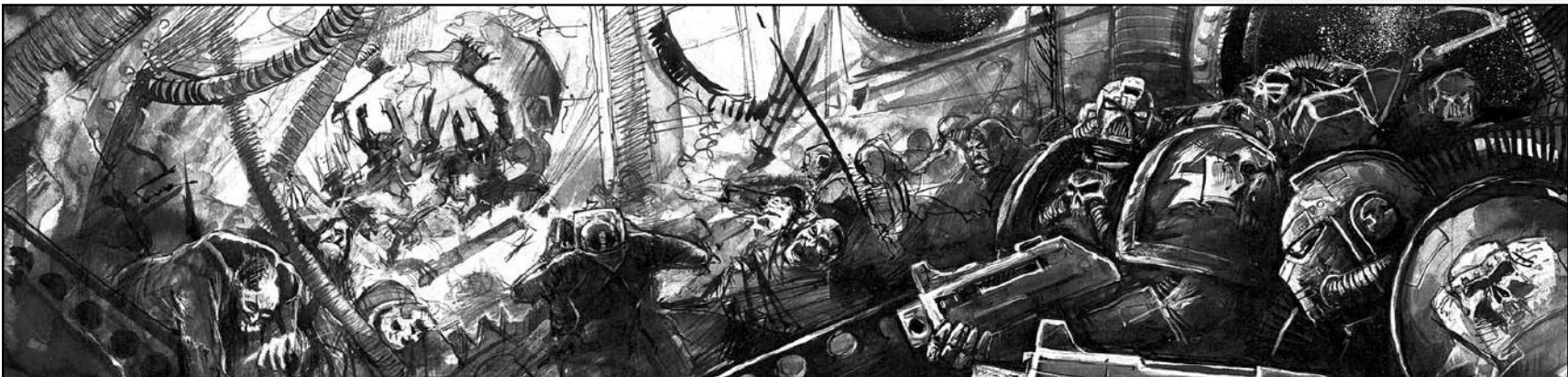

SPACE MARINE STRIKE CRUISER 145 points

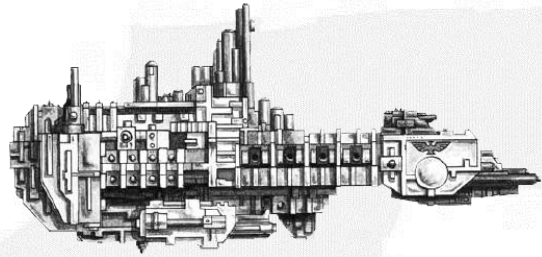

| TYPE /HITS | SPEED | TURNS | SHIELDS | ARMOR | TURRETS |
|---------------------------|-------|--------------------|--------------------|-------|--------------------|
| Cruiser/6 | 25cm | 90° | 1 | 6+ | 2 |
| ARMAMENT | | RANGE | FIREPOWER/STRENGTH | | FIRE ARC |
| Port Weapons Battery | | 30cm | 4 | | Left |
| Starboard Weapons Battery | | 30cm | 4 | | Right |
| Prow Bombardment Cannon | | 30cm | 3 | | Left/ Front /Right |
| Prow Launch Bay | | Thunderhawks: 20cm | 2 | | N/A |

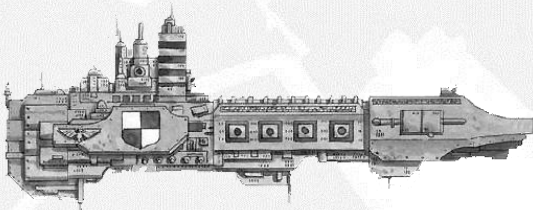

Strike Cruiser *Fors Clavigera* (Grey Knights Chapter)

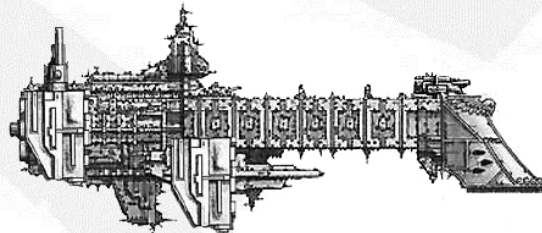

Strike Cruiser *Eternal Defiance* (Exorcists Chapter)

Strike Cruiser Variants

Throughout the Imperium of Man, the various Adeptus Astartes Chapters utilize strike cruisers that while the same in essential purpose, sometimes tend to differ significantly in details, appearance and specific weapons arrangement. They may incorporate the following refits for the point costs indicated.

Replace launch bays. A strike cruiser may replace its launch bays for strength-6, Speed: 30cm torpedo tubes or a firepower-5, range 30cm (front arc only) bombardment cannon battery for no change in cost. Torpedo tubes may fire normal or boarding torpedoes.

Replace bombardment cannon. A strike cruiser may replace its prow firepower-3, Left/Front/Right bombardment cannon for a strength-1, range: 30cm lance firing Left/Front/Right for +20 points.

At a minimum, as many strike cruisers in the fleet must be of the basic profile listed above as all other variants combined. Additionally, any number of strike cruisers can each purchase an additional shield for +15 points.

Like battle barges of the Adeptus Astartes, strike cruisers do not represent a single class of vessel but instead consist of a broad range of types with differing weapons and systems designed primarily for rapid response, able to quickly fight their way into a contested system and rapidly deliver Space Marines and their wargear to the front. To this end strike cruisers can and do take a variety of forms.

Like venerable battle barges of old, a number of strike cruiser designs date far back to the centuries immediately following the development of the Codex Astartes. While most Chapters with limited resources will typically operate a single type of strike cruiser, it is not uncommon for some to operate two or more distinct types and configurations of strike cruisers with slightly differing capabilities and weapon arrangements, especially among the older Chapters with histories dating back several millennia. The effectiveness of strike cruisers has not gone unnoticed by the Imperial Navy. In the intervening millennia, they inspired not only the creation and implementation of light cruisers by the Imperial Navy, but various weapon configurations lent themselves to a number of light cruiser classes used throughout the Imperium.



SPACE MARINES CRUSADE FLEET LIST

FLEET COMMANDER

0-1 Master of the Fleet

You may include one Master of the Fleet. If a fleet includes any battle barges, he must be assigned to a battle barge. The Master of the Fleet may be assigned to a venerable battle barge or fortress monastery if one is present, but does not have to be. If the fleet is over 750 points, a Master of the Fleet must be included to lead it.

Master of the Fleet (Ld10) 50 points

You may buy Fleet Commander re-rolls for the Master of the Fleet. If the Master of the Fleet is assigned to a fortress-monastery, his own re-rolls are added to those of the fortress-monastery and may be used by the entire fleet.

One re-roll 25 points
Two re-rolls 50 points
Three re-rolls 75 points

In addition, the Master of the Fleet's ship may carry a Terminator boarding party for +50 points.

FORTRESS-MONASTERY

0-1 Fortress-Monastery

If your fleet is worth at least 2,000 points, it may include one Fortress-Monastery.

Space Marine Fortress-Monastery 1,000 points

As the base of operations for the entire Chapter, the fortress-monastery may purchase re-rolls, which it may use for its own command checks only. If the Master of the Fleet is assigned to a fortress-monastery, its re-rolls are added to those of the Master of the Fleet.

One re-roll 25 points
Two re-rolls 50 points
Three re-rolls 75 points

CAPITAL SHIPS

0-3 Battle Barges

You may include one Space Marine battle barge for every 1,000 points in the fleet or portion thereof. The fleet must be worth at least 1,000 points to include a

single Venerable battle barge (counting as one of the three allowed), chosen from any available Imperial or Chaos battleship, grand cruiser, battlecruiser or heavy cruiser at the listed cost, plus an additional +35 points for its Space Marine crew.

Venerable Battle Barge. points: varies
Space Marine Battle Barge. 425 points

0-10 Strike Cruisers

Space Marine Strike Cruiser 145 points

ESCORTS

The fleet can have any number of escorts, in squadrons of two to six vessels.

Nova Frigate 50 points
Gladius Frigate 45 points
Hunter Destroyer 40 points

USING A SPACE MARINE CRUSADE FLEET

The Crusade Fleet List represents all the most aggressive, zealous and insular Space Marine Chapters, most notably the Black Templars. They do not rule over great swaths of the Imperium as other Chapters might, and few of them even have a homeworld of their own. Instead, these crusading armies endlessly roam the galaxy, engaged in near constant warfare with the Emperor's enemies (or in some cases, in endless pursuit of their own ancient foes). This same zeal breeds in them a great distrust of non-Space Marines, indeed a distrust even of other Chapters, who they believe incapable of the same purity which they themselves make a virtue, meaning they will seldom, if ever, seek the aid of other arms of the Imperium.

As well as true Crusade Chapters, the fleet list above is ideal for representing fleet-based Chapters, particularly those that operate from a fortress-monastery, such as the Fire Hawks or Dark Angels. While not strictly a Crusading Chapter, this list is particularly suited to the Dark Angels, since it represents their famously secretive method of

operation. Other Chapters, such as the Imperial Fists, the Crimson Fists and so on, occasionally launch Crusades though not exclusively, so they can be equally well represented by this fleet list or the Codex Astartes fleet list on p.30 of Armada.

Ordnance and Upgrades

Any ship with launch bays carries Thunderhawks and Thunderhawk Annihilators. Ships with torpedo tubes are armed with ordinary and boarding torpedoes. All Space Marine capital ships are equipped with drop pods. Any battle barge or strike cruiser in the fleet may be equipped with an Honor Guard for +10 points per ship. A fortress-monastery is equipped with Terminator boarding parties and an Honor Guard as part of its point cost.

Attack Rating

A Space Marine Crusade Fleet has an attack rating of 3. If the fleet includes a fortress-monastery, it has an attack rating of 1; even Space Marines find it difficult to launch a surprise blitz with a billion tons of fortress monastery in tow!

Scenarios

A Space Marine Crusade fleet with a fortress-monastery will always be the defender in a scenario. Players should use any method desired to pick a scenario, assigning the Crusade fleet as the defender. An alternative is to determine the attacker and defender normally with the Space Marine player electing if desired to use the fortress monastery if selected as the defender. Like the rules for a Ramilies Star Fortress, the fortress-monastery should only be used as a defense or in some scenarios substituting for the planet itself.

Reserves and Allies

A Space Marine Crusade fleet will not take ships from or provide ships to any other fleet list as reserves or allies, including Imperial Navy, Rogue Trader or Adeptus Mechanicus fleet lists.

SPACE MARINES DOMINION FLEET LIST

FLEET COMMANDER

0-1 Master of the Fleet

You may include one Master of the Fleet. If a fleet includes any battle barges, he must be assigned to a battle barge. If a Venerable battle barge is included in the fleet, the Master of the Fleet must be assigned to it. If the fleet is over 750 points, a Master of the Fleet must be included to lead it.

Master of the Fleet (Ld10) 50 points

You may buy Fleet Commander re-rolls for the Master of the Fleet.

One re-roll 25 points

Two re-rolls 50 points

Three re-rolls 75 points

In addition, the Master of the Fleet's ship may carry a Terminator boarding party for +50 points.

Space Marine Captains

Aside from the Space Marine vessels themselves, certain important Imperial Navy vessels within a Dominion Fleet may well have Space Marine commanders assigned to them. Any Imperial Navy battleship, grand cruiser or battlecruiser may have a Space Marine Captain assigned to it. Space Marine Captains roll against the Space Marines leadership table instead of the normal leadership table. Except for this bonus, Imperial Navy ships led by a Space Marine Captain do not benefit from any of the Space Marines special rules concerning boarding, hit and run attacks, ordnance, etc.

Space Marines Captain +25 points

In addition, a ship led by a Space Marine Captain may carry an Honor Guard for +10 points.

CAPITAL SHIPS

0-3 Battle Barges

You may include one Space Marine battle barge for every 1,000 points in the fleet or portion thereof. The fleet must be worth at least 1,000 points to include a single Venerable battle barge (counting as one of the three allowed), chosen from any available Imperial

or Chaos battleship, grand cruiser, battlecruiser or heavy cruiser at the listed cost, plus an additional +35 points for its Space Marine crew.

Venerable Battle Barge. points: varies
Space Marine Battle Barge. 425 points

0-10 Strike Cruisers

Space Marine Strike Cruiser 145 points

ESCORTS

The fleet can have any number of escorts, in squadrons of two to six vessels. The listed point costs reflect their Space Marine crews.

Nova Frigate 50 points

Firestorm Rapid Strike Vessel 45 points

Gladius Frigate 45 points

Sword Rapid Strike Vessel 40 points

Falchion Rapid Strike Vessel 40 points

Hunter Destroyer 40 points

Cobra Rapid Strike Vessel 35 points

USING A SPACE MARINE DOMINION FLEET

The Master of each Space Marine Chapter is its leader and spiritual head. He leads his troops in battle and acts as the figurehead for the entire Chapter. As some Chapters rule entire planets or even sub-sectors of space, a Chapter Master may well act as the head of government as well, effectively as the Imperial Commander of a whole planet or system. Particular examples are the Ultramarines, who rule over the dominion of Ultramar, and the Salamanders, which enjoy close ties with the people of Prometheus.

Where this is the case, other local military assets, though not strictly subservient to the Chapter and with their own command structures in place, will nonetheless find themselves more often under the sway of their superhuman neighbors than might other independent regiments and fleets from regions not ruled by Space Marines. Any contact with Space Marines strikes a mixture of fear and awe in the

hearts of mortal men, and such preeminence occurs naturally wherever man and Marine stand side by side. In such circumstances Space Marine commanders will assume overall control for the defense of a region, though they are inevitably too few in number to enact such plans themselves. Where a Chapter holds sway over such a dominion, Space Marine fleets and vessels of the Imperial Navy will often be found acting in concert.

Ordnance and Upgrades

Any Space Marines capital ships with launch bays carry Thunderhawk gunships. Any vessel with a Space Marine Captain can have an Honor Guard for +10 points. Imperial Navy vessels are equipped with their own standard ordnance (even if they have Space Marine Captains) and cannot be given any form of Space Marine upgrade. This includes those listed on the table on p.157 of the rulebook.

Attack Rating

A Space Marine Dominion Fleet has an attack rating of 3. This is reduced to 2 if the fleet has any Imperial Navy, Mechanicus or Rogue Trader vessels at all.

Reserves and Allies

A Space Marine Dominion Fleet has close ties with nearby Imperial Navy forces. Contrary to the normal rules, a dominion fleet can take Imperial Navy vessels as normal reserves and reinforcements, including Adeptus Mechanicus and non-xenos Rogue Trader vessels. For purposes of choosing reserves, battle barges count as battleships, and strike cruisers count as cruisers for the selection of any cruiser (battlecruiser, etc.) type. When reserves are taken in this manner, the fleet can have up to twelve cruisers. However, in the course of a campaign, a Dominion Fleet cannot take reinforcements from the Space Marines table listed on p.157 of the Battlefleet Gothic rulebook.



KNOWLEDGE IS POWER

EXPLORATOR FLEETS OF THE ADEPTUS MECHANICUS

THE CULT MECHANICUS

The Cult Mechanicus believes knowledge to be the manifestation of divinity, and holds that anything embodying or containing knowledge is holy because of it. The supreme object of devotion is therefore the omniscient Machine God (also known as the *Deus Mechanicus* or *Omissiah*), an eminent and omnipotent spirit governing all machinery and knowledge. Generally, this deity is held to be either subordinate to or an aspect of the God-Emperor (or, most commonly within the Cult itself, both are held to be aspects or faces of the same divine being). The Omissiah is believed to be friendly to humanity, and to be the originator of all human technological and scientific knowledge. Subservient to the Omissiah are the pantheistic Machine Spirits, minute fragments of the Machine God that are believed to inhabit all machinery and which must be appeased before a piece of technology is used or repaired, lest the machinery fail.

The Cult Mechanicus holds a virtual monopoly on technology, its own tenets and beliefs permeating through their rituals into the common superstition of Imperial citizens. The Adeptus Mechanicus is vitally important to humanity because the Imperium, despite its technologically advanced state, has a very limited scientific knowledge of how its technology actually functions. This has only reinforced the prevailing Imperial view that the building and use

of advanced machinery is almost a magical or religious act, fraught with ritual and inviolable instructions. The Adeptus Mechanicus, with its inherent understanding of the Machine Spirit and the Machine God, has a near-monopoly on Standard Template Construct (STC) designs and other advanced Imperial technological knowledge, and consequently wields a tremendous amount of power in the Imperium. The vast foundries of the Adeptus Mechanicus are solely responsible for providing to the Imperium of Man all technical devices and machinery from mundane farm equipment to vast interstellar warships.

THE FORGE WORLDS

Although often held to be planet-spanning factories, as much as half of a forge world owned by the Adeptus Mechanicus is primarily given over to huge repositories of technical knowledge. These immense libraries and databanks of information are highly eclectic and disorganized, so that one may find a crystal storage device containing information on biogenetic engineering next to a scroll covered with designs for steam locomotives. Techpriests are a holy order that worships the Machine God and the intimate knowledge of technology that he holds. They jealously guard their independence, and even the Inquisition will not lightly interfere with or recklessly investigate the Mechanicus on one of their own forge worlds. It is ordered in a strong hierarchy, but details on what form this takes are not made widely available to those who have not been so indoctrinated. Generally, more highly positioned techpriests are expected to have more seniority and knowledge than lower ones, and are consequently more important as greater repositories of knowledge.

To the Techpriests, flesh is merely an inconvenience; weak and frail in comparison to the mighty pistons,

gears and chains of machinery. It must be sustained artificially beyond a certain point and, if one is to make most use of it, much of it needs replacing by newly grown parts or, more preferably, manufactured limbs, organs and systems. Their brains incorporate devices known as memo chips, ingrams or electrografts, which allow their memories to store an incredible amount of information and access it quickly. They are often fitted with a variety of neural plugs which allow them to jack in to the network of a terminal or machine, becoming part of its operating or control system. It is not uncommon for the most senior Techpriests to have entire limbs replaced with more functional devices, such as lifting arms, augur arrays and weapons. The most aged of the Adeptus Mechanicus are many, many centuries old, kept alive by horrifically produced anti-aging elixirs which nourish the few parts of mortal flesh left on their bodies, although the wealth of knowledge and experience crammed into their brains has entirely divorced them from reality and driven them mad.

THE MYSTERIES OF THE CULT MECHANICUS

1. LIFE IS DIRECTED MOTION.
2. THE SPIRIT IS THE SPARK OF LIFE.
3. SENTIENCE IS THE ABILITY TO LEARN THE VALUE OF KNOWLEDGE.
4. INTELLECT IS THE UNDERSTANDING OF KNOWLEDGE.
5. SENTIENCE IS THE BASEST FORM OF INTELLECT.
6. UNDERSTANDING IS THE TRUE PATH TO COMPREHENSION.
7. COMPREHENSION IS THE KEY TO ALL THINGS.
8. THE OMNISSIAH KNOWS ALL, COMPREHENDS ALL.

The lowest ranks of Techpriest have mainly maintenance and construction duties, but as a Techadept progresses and acquires greater knowledge, he is relieved from day to day tasks to study ancient texts and learn the greatest mysteries and techniques. Thus, the Adeptus Mechanicus endeavors to maintain this position of absolute knowledge and authority, and a Techpriest who feels that this is threatened will go to any lengths to protect his power, including murder, extortion, kidnapping, sabotage and terrorism. After many decades of service, techpriests may be elevated to the rank of Magos, from where they may begin service in one of the many sub-sect Divisios and factions within the Cult. It is the Fabricator-General that is the highest-ranking member of the Adeptus Mechanicus on any given forge world, serving as its de-facto planetary governor. His authority is exceedingly great, and in fact the Fabricator-General of Mars holds a permanent seat among the High Lords of Terra. However, among the lower ranks of Techpriests, held in highest regard are the Magos Explorator.

THE QUEST FOR KNOWLEDGE

The Cult Mechanicus follow Sixteen Universal Laws, which define their existence. Possibly the most revealing is the Eight Universal Law: The Ommissiah knows all, comprehends all, the Ommissiah is the Supreme Being, the entity able to comprehend all knowledge in the universe. To fully understand the Machine God is the ultimate, overarching goal of the Adeptus Mechanicus, and so they strive to attain enlightenment through their studies and biological/mechanical symbiosis. The communal and personal attempt at this form of enlightenment is known as the Quest for Knowledge. The Cult believes that all knowledge already exists in the universe, and it is primarily a matter of time before it can be gathered together to complete the Quest. Much of this lost knowledge is widely believed to reside in the form of the now-lost STC's, and no effort will be spared to pursue any lead that may reveal the existence of an even partially-functioning STC system. The Cult is therefore disinclined to perform

much basic research and development. Despite this, some original scientific research does continue on Mars and the other Forge Worlds of the Imperium, enough to keep Imperial technology advancing steadily, if extremely slowly.

To this end it are the Magi Explorator that seek out this information. Obsessed with the quest for knowledge, they search high and low across the known galaxy for lost Standard Template Constructs and ancient archeotech. They view this endeavor as paramount as and more important than any other concern, and is considered by them to be among the most vital missions of its space fleet. A breed apart from regular techpriests, any Explorator or member of his team will willingly walk into forgotten catacombs, even at risk of death, for snippets of long-forgotten knowledge. Toward this end the Adeptus Mechanicus have at their disposal a large fleet of starships. Because the Quest for Knowledge can involve long, arduous forays into unexplored space, it is important that they be heavily armed and armored. This is not only for their own protection from those who covet their technology but to engage in combat when necessary to secure vital data or artefacts that may prove crucial to the Quest. Though the total number of ships the Adeptus Mechanicus has at its disposal dispersed among its many forge worlds is far outnumbered by that of the Imperial Navy, it goes without saying that those responsible for all starship construction reserve for themselves among the most powerful and best-equipped warships encountered anywhere in the Imperium.

May your weapons be guarded against malfunction, as your soul is guarded from impurity. The Machine God watches over you. Unleash the weapons of war.
- Chant for the Prevention of Malfunction

ADEPTUS MECHANICUS SPECIAL RULES

Adeptus Mechanicus vessels follow all rules for Imperial Navy vessels except specifically as outlined by the following.

Leadership. While the Adeptus Mechanicus have dedicated starship crews, they are led by senior Tech Magi of their order rather than the nobility of the Imperial Navy. They follow a hierarchy as completely different from the Navy as is the Adeptus Astartes. Consequently, they use a leadership table different from other fleets. To determine base leadership for a given vessel, roll a D6 against the following table:

| | | |
|------------|-----------------|-----------------|
| 1= Ld 7 | 2 to 3= Ld 8 | 4 to 6= Ld 9 |
|------------|-----------------|-----------------|

Any vessel that rolls a 6 when determining base leadership may select any one desired refit from the Mechanicus Gifts table instead of rolling for it randomly (this does not mean you get an extra one!). This option cannot be used if the vessel embarks an Archmagos Veneratus.

Attack Rating. The Adeptus Mechanicus have a starting attack or initiative rating of 2.

Hit and Run Attacks and Boarding Actions

While Mechanicus vessels have companies of Skitarii Troopers embarked aboard in place of Naval armmen, the vast majority of their crews will be made up of techpriests

Thus do we invoke the Machine God. Thus do we make whole that which was sundered.
-*Hymn of Reforging*

with little combat experience and servitors hardwired to their posts. Though they may conduct hit and run raids normally, the attacker may re-roll the dice if desired during boarding actions as well as Hit and Run attacks against Mechanicus vessels, but the second roll stands. Mechanicus vessels (including battleships) do not normally utilize assault boats or boarding torpedoes.

Firing Upon Friendly Hulks

Every attempt will be made to recover a Mechanicus vessel that is lost. However, they will not allow their holy technology and precious knowledge fall into enemy hands. Unlike other fleets, Mechanicus vessels can take a leadership check to fire upon their own vessels that have been hulked to deny them to the enemy. This rule only applies to Mechanicus vessels shooting at Mechanicus drifting hulks, and not Imperial Navy, reserve or allied vessels in the fleet.

Gifts of the Ommissiah

Adeptus Mechanicus vessels represent the very apex of Mankind's technical prowess, and they have access to resources and technology unavailable to the vast majority of the Imperium. All Mechanicus capital ships add +1 to a given vessel's original turret value. Mechanicus capital ships must also roll a D6 once against the Mechanicus Gifts table. These improvements are already included in the point cost assigned in the Adeptus Mechanicus Fleet List. Re-roll any refit that is not applicable to the vessel.

D6 Mechanicus Gift Table

- Emergency Energy Reserves:** When crippled, the ship only reduces turrets, shielding and weapons by 25% rather than 50%. The vessel still counts as crippled in every other respect.
- Advanced Engines:** The ship gains +5cm speed, as well as +1D6 when on All Ahead Full special orders.
- Repulsor Shielding:** Ignore all negative effects of having a blast marker or gas clouds in contact with the ship's base as it applies to leadership, movement and repairing critical damage. This effect goes away if the ship suffers "Shields Collapsed" critical damage.

- Fleet Defense Turrets:** Up to two turrets on the ship are exchanged for fleet defense turrets capable of protecting itself or any one other vessel within 15cm each ordnance phase, adding +2 to the turret strength of the ship it is defending (this does not alter bomber attack rolls when used to defend another vessel). These otherwise work exactly as normal turrets do in all other respects.
- Gyro-stabilized Targeting Matrix:** Ship weapons are reduced to 75% instead of 50% when on All Ahead Full, Come To New Heading or Burn Retros special orders. Nova Cannon still cannot fire.
- Augmented Weapon Relays:** Weapon batteries shift left on the gunnery table before all other modifiers are applied. Lance hits count double on rolls of a 6.

THE WARNINGS OF THE CULT MECHANICUS

- THE ALIEN MECHANISM IS A PERVERSION OF THE TRUE PATH.
- THE SOUL IS THE CONSCIENCE OF SENTIENCE.
- A SOUL CAN BE BESTOWED ONLY BY THE OMMISSIAH.
- THE SOULLESS SENTIENCE IS THE ENEMY OF ALL.
- THE KNOWLEDGE OF THE ANCIENTS STANDS BEYOND QUESTION.
- THE MACHINE SPIRIT GUARDS THE KNOWLEDGE OF THE ANCIENTS.
- FLESH IS FALLIBLE, BUT RITUAL HONORS THE MACHINE SPIRIT.
- TO BREAK WITH RITUAL IS TO BREAK WITH FAITH.

The Quest for Knowledge

Quick to incorporate recently-rediscovered technology before it is approved for widespread use, Adeptus Mechanicus vessels place great reliance on archaeotech that have much higher power requirements and correspondingly smaller overload tolerances and redundancy than those equipping comparable Imperial Navy vessels. Their ships are crewed with a very high proportion of repair servitors and tech adepts intimately familiar with the workings of their vessel. Mechanicus vessels always add +1D6 to their rolls when attempting to repair critical damage. However, because these ships are commonly relied upon to test untried and sometimes Xenos technology for extended periods of time, Mechanicus vessels will on occasion suffer adverse, unanticipated consequences that in some cases may endanger the entire ship and its crew. In addition to any subplots that may be taken normally as desired, a fleet including any Adeptus Mechanicus capital ships must roll a single D6 against the following subplot table:



D6 Quest For Knowledge Table

- 1. Extended Duty:** The Quest for Knowledge can be long and arduous, sometimes seeing the fleet deep in unexplored space far away from logistical support for exceedingly long periods. Roll a D6 for each Mechanicus capital ship. On a 1 it takes D3 damage, on a 2 it suffers -1 Ld to take Lock-on or Reload special orders. Rolls of 3+ have no effect. You must destroy or cripple more enemy ships than you lose. (+1/0 renown)
- 2. Xenos Logic:** Due to unforeseen phenomena, the complex workings within the capital ships of the Adeptus Mechanicus have become unreliable at best and catastrophic at worst. Roll a D6 for each Mechanicus capital ship in the fleet. On a 1, 2 or 3, roll against the critical damage table. (+2/-1 renown)
- 3. Mimic Drive:** The Adeptus Mechanicus encounter partial STC plans for a drive capable of imitating the signature of a capital ship. Add a cruiser to the fleet, keeping its identity a secret. This vessel actually has all the characteristics of a transport ship and is worth zero victory points. If it is fired upon by the enemy, then the mimic drive is proven to be effective. (+1/-1)
- 4. Sacred Vessel:** The ship is an example of or contains much valued archaeotech and must be protected at any cost. Choose one Mechanicus capital ship in your fleet. This vessel cannot be crippled or destroyed. (+1/-1)
- 5. The Prize:** Reliable sources have confirmed that an enemy ship contains an extremely valuable example of archaeotech, or possibly remnants of a working STC system! Even if the ship is only crippled, it will grant an easier venture to capture it. Nominate one enemy capital ship. You must cripple or destroy it. If the ship explodes, no renown is gained or lost. (+1/-2)
- 6. Experimental Ship:** Recovered ancient technology or alien artefacts are sometimes retrofitted to a ship to change its performance in one way or another. Sometimes the results are beneficial, but very rarely can such devices be accommodated without significant cost or sacrifice to the vessel. Pick one cruiser in the

fleet. This vessel has been recently fitted with an experimental system that has not yet been tested operationally. These modifications are in addition to any refits taken normally by a Mechanicus vessel. Roll a D6 on the following two tables to see how the ship has been altered (Re-roll any result that cannot be applied to the vessel). This ship must not be crippled or destroyed so that it can be examined to review its performance. (+1/-1)

| D6 | IMPROVEMENT ROLL RESULT |
|----|---|
| 1 | All weapons (except ordnance) increase maximum range by +15cm. |
| 2 | The ship gains +1 Shield. |
| 3 | All turrets re-roll misses when defending against ordnance. |
| 4 | The ship can turn an additional +45 degrees. |
| 5 | All friendly vessels within 15cm gain an additional +1 leadership when the enemy is on special orders (max 10). |
| 6 | Dorsal or prow lances ignore shields on a roll of 6. |

| D6 | SIDE EFFECT ROLL RESULT |
|----|---|
| 1 | Weapons battery firepower and lance strength reduced by 50% (rounding up). |
| 2 | The ship loses 2 hit points. |
| 3 | The ship loses 2 turrets (this is after adding the +1 turret all Mechanicus capital ships are equipped with). |
| 4 | The ship must move an additional 5cm before it can turn. |
| 5 | The ship loses 5cm speed. |
| 6 | Dorsal or prow lances can only hit targets on a roll of 6. |

In ancient times, men built wonders, laid claim to the stars and sought to better themselves for the good of all. But we are much wiser now.

- Archmagos Ultima Cyrol

OMNISSIAH'S VICTORY, ARK MECHANICUS 415 Points

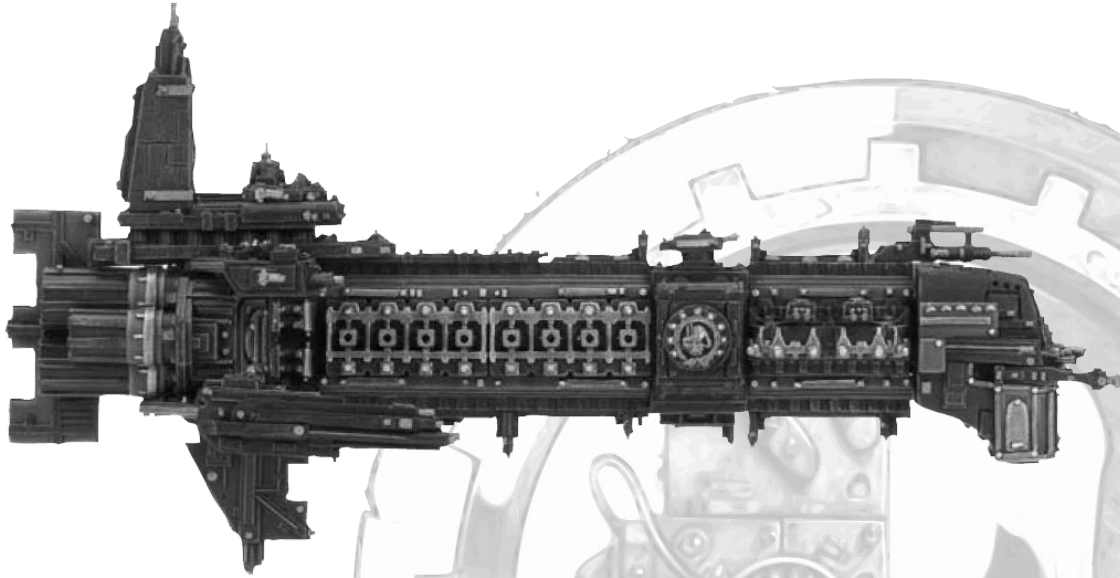

Over many millennia, a large number of starships of various sizes, fitting no specific classification, have been seen bearing the insignia of the Adeptus Mechanicus. Many of these ships are incredibly ancient vessels, possibly recovered space hulks, re-commissioned so as to examine their characteristics under normal operation. A notable few of these are the unimaginably vast, almost mythical Ark Mechanicus vessels, said to endlessly ply the stellar main in the Quest for Knowledge. Led by a Venerated Archmagos Explorer, they will follow up any lead that may result in discovering a working Standard Template Construct, the revered holy grail of the Cult Mechanicus.

These vessels are rarely encountered by others as they perform their missions in the service of those who give life to these behemoths of the stars. One such vessel is the Ommissiah's Victory, said to predate even the Great Crusade. While this cannot be proven, it is known to have taken part in the Noloptis Crusade as far back as M33. Some have suggested that aspects of its design were lent to both the Retribution battleship as well as the Victory battleship most commonly encountered in Segmentum Tempestus. While the Adeptus Mechanicus have not been forthcoming regarding the veracity of this information, records exist of the Ommissiah's Victory spending a considerable amount of time in the vicinity of Bakka and its surrounding forge worlds.

| TYPE /HITS | SPEED | TURNS | SHIELDS | ARMOR | TURRETS |
|---------------------------|-------|--------------|--------------------|------------|--------------------|
| Battleship/12 | 20cm | 45° | 4 | 6+ prow/5+ | 4 |
| ARMANENT | | RANGE | FIREPOWER/STRENGTH | | FIRE ARC |
| Port Weapons Battery | | 60cm | 10 | | Left |
| Starboard Weapons Battery | | 60cm | 10 | | Right |
| Port Lance Battery | | 60cm | 2 | | Left |
| Starboard Lance Battery | | 60cm | 2 | | Right |
| Dorsal Lance Battery | | 60cm | 2 | | Left/ Front /Right |
| Prow Nova Cannon | | 30cm - 150cm | 1 | | Front |

Special Rules: Arks Mechanicus such as the *Ommissiah's Victory* are ponderous vessels and cannot use Come To New Heading special orders. The *Ommissiah's Victory* is a unique vessel; only one may ever be present in the fleet. It can only be taken in a fleet made up primarily of Adeptus Mechanicus vessels.

The profile for *Ommissiah's Victory* already reflects the rules for Adeptus Mechanicus vessels. It is equipped with Repulsor Shields and Augmented Weapon Relays as part of its point cost, and can take no other refits from the Mechanicus Gifts table. You may include *Ommissiah's Victory* in place of one battleship in an Adeptus Mechanicus fleet if it totals 1000 points or greater. If used, it must be the flagship and embark a Venerated Archmagos for the cost listed in the fleet list. The *Ommissiah's Victory* cannot take any other refits except those described in the notes for this vessel, though in a campaign it can earn others normally from p.156 of the Battlefleet Gothic Rulebook.

The *Ommissiah's Victory* represents only one of several unique Arks Mechanicus that ply the void. Though more common Mechanicus battleships normally reprise the role of Ark Mechanicus in a fleet, there are a few other unique vessels that do not fit into any normal classification. Using the exact profile above and special rules listed here, an Ark Mechanicus may exchange its broadside lance batteries for strength-2 launch bays for +10 points. In no case can more than one Ark Mechanicus ever be used in a fleet.

USING VESSELS OF THE ADEPTUS MECHANICUS

VESSELS OF THE ADEPTUS MECHANICUS

As the ability to efficiently produce long-range lance weaponry by Mars was perfected in late M37, the need to reserve these complex and expensive weapons for only a relatively small number of their own hulls no longer existed. To avoid raising the concern of the Imperial Navy, The Adeptus Mechanicus does not utilize any battlecruisers in their own fleets, though they still produce them for the Imperial Navy as required. Every Mechanicus cruiser (not light cruiser) is equipped with a single 60cm range dorsal lance battery firing left/front/right. These improvements are already included in the point cost assigned in the Adeptus Mechanicus Fleet List. Adeptus Mechanicus Endeavor and Endurance light cruisers may replace their prow torpedoes with a single 30cm range dorsal lance battery firing left/front/right for no cost. They can upgrade their prow armor to 6+ at no cost. However, if this option is taken, their turning radius is reduced to 45 degrees.



WEAPONS OF THE ADEPTUS MECHANICUS

The Forge Worlds of the Adeptus Mechanicus have at their disposal weapon fabrication techniques too complex and difficult to maintain for widespread deployment throughout the Imperial Navy, though they are far less restricted from applying these special weapons to their own vessels. All Adeptus Mechanicus cruisers (not light cruisers) with armor 6+ prows can replace their prow torpedoes with a Nova Cannon for +20 points, even if this option is not normally provided for a given cruiser class (such as the Gothic). A Mechanicus Retribution battleship can make this trade for +10 points. Adeptus Mechanicus cruisers that would normally be equipped with 30cm Weapon Batteries can incorporate plasma-boosted batteries that increase their range to 45cm for +10 points. With the exception of choosing between prow torpedoes or Nova Cannon, Mechanicus vessels can take any combination, all or none of these improvements as desired.

You may have any number of Adeptus Mechanicus escorts in the fleet, chosen from the fleet list on the next page. Note that these are taken from both the Imperial Navy and Space Marines fleet lists, but they must be taken for the point costs listed on the fleet list and not from their basic profiles. These vessels count as Mechanicus vessels and use all rules that Mechanicus vessels do, but do not have access to the Mechanicus Gifts table, nor do they get any boarding action bonuses Space Marine escorts may have. Unlike their capital ships, Mechanicus escorts do not have the +1 turret as part of their point cost and do not get this refit automatically. They however may each purchase +1 turret for +5 points. If taken, all the escorts in a squadron must take this refit, not just individual escorts in the squadron. Escorts must be

When uttering the incantation, mark well that the rod is upon and not within the intake. The second incantation should not be uttered until all the fumes have come forth, then the way shall be clear for the sacred words to penetrate unto the heart of the engine. If the mounting be hot say the third rune, if it be cold the fourth rune is more appropriate. For then the wrath of the engine will be aroused...

- From the Book of Five Runes

painted to match the Mechanicus fleet to be of the Adeptus Mechanicus; you cannot take Imperial Navy or Space Marine vessels painted for another fleet and call them Mechanicus vessels!

Attack craft carriers use the same Fury interceptors and Starhawk bombers utilized by the Imperial Navy, though they do not use assault boats, as they do not engage in hit and run attacks in the traditional sense. All Adeptus Mechanicus capital ships that utilize torpedoes can be equipped with refitted torpedoes as described on p. 156 of Armada for +20 points (+30 points for the Retribution, +10 points for the Endeavor and Endurance).

RESERVES AND ALLIES

Adeptus Mechanicus vessels can be used as reserves in any Imperial Navy or Space Marine fleet list. Contrariwise, Imperial Navy vessels from any fleet list can be used as reserves in a Mechanicus fleet, following all normal rules for these vessels. No more than one reserve vessel can be taken for every three capital ships in the fleet. For every three cruisers, one reserve cruiser-class, battlecruiser or grand cruiser may be taken. For every three battleships, one battleship-class vessel may be taken. Vessels taken as reserves count respectively toward the total number of cruisers and battleships allowed in a Mechanicus fleet. Ships that can be allied with Imperial Navy vessels, such as the Deimurg and Rogue Traders can also ally themselves with Mechanicus vessels normally, even if reserves are also used.

Space Marines can also be used as reserves in a Mechanicus fleet that does not include regular Imperial Navy capital ships or alien vessels of any type. They can be taken in the ratio of one strike cruiser for every three Mechanicus capital ships, and one battle barge for every three strike cruisers.

Mechanicus vessels cannot be placed in squadrons with Rogue Trader, regular Imperial Navy or Adeptus Astartes vessels. Mechanicus re-rolls cannot be used on these vessels, and other fleet commander re-rolls cannot be used on Mechanicus vessels.

An Adeptus Mechanicus fleet commander can only be embarked on a Mechanicus ship. Mechanicus starships are rare and precious vessels, and they will not be expended lightly, regardless of the circumstances. When used as reserves in other fleets, Mechanicus vessels that are crippled will attempt to disengage whenever possible, otherwise they will move toward the closest table edge. Those in capital ship squadrons will disengage when half or more of the vessels in the squadron are crippled. There are no restrictions on how many reserve Imperial Navy, Space Marine or Rogue Trader escorts are included in an Adeptus Mechanicus fleet, as long as Xenos vessels and reserve Space Marine vessels are not included in the same fleet. Escorts taken in this manner must be taken from the same fleet list reserve capital ships are being drawn from.

CAMPAIGNS

The Mechanicus refit that ships earn at the start of a campaign are the ones they keep until they are destroyed. In the course of a campaign, Mechanicus vessels can only earn additional refits from the standard Imperial Navy refit table or the Space Marines reinforcement table. They cannot continue to gain refits from the Mechanicus Gifts table. Adeptus Mechanicus vessels are far too rare and precious to be carelessly expended in the fires of war. However, those vessels so engaged will always receive priority when requiring repair or rework at shipyards throughout the Imperium. When calculating repair points at the end of a battle, the Adeptus Mechanicus fleet will always have +1 Repair point for every 10 renown or portion thereof the fleet commander has earned. When rolling appeals, Adeptus Mechanicus vessels get a +1 roll modifier to earn refits but a -1 roll modifier to earn reinforcements or Space Marines. Space Marines can be earned in this manner in a fleet that contains regular Imperial Navy vessels, but not one that contains alien vessels of any type.

Even the most junior tech-adepts are typically far more familiar with the workings of their vessel and the capabilities of its weapon and defensive systems than comparable Imperial Navy officers and ratings, though this does not necessarily correlate to how well their vessels are utilized in combat. Because even senior Mechanicus techpriests tend to approach challenges in terms of engineers rather than tacticians, it is sometimes difficult for them to appreciate the finer aspects of tactical discipline in the heat of battle. However, the resources they are able to call upon when repairing and refitting their vessels are the envy of even the most senior Imperial Navy commanders. Additional refits earned by renown in the course of a campaign as listed on the following table are at no cost to the vessel they are applied to, and they are separate from refits earned by appeal, which must be paid for normally. Unlike normal refits, these free refits may be taken from the Mechanicus Gifts table if desired (this is the only way a ship can ever earn more than two refits from the Mechanicus Gifts table). However, they can only be applied to the fleet commander's flagship, they must be rolled randomly, and no refit can be used more

than once (re-roll the result). Should that vessel be lost, those refits are lost as well and do not follow the fleet commander to his new flagship. However, Mechanicus fleet commanders still have access to the number of refits they earned, and can roll randomly against the Mechanicus Gifts table the number of refits they are entitled to and apply them to their new flagship.

Mechanicus Promotion Table

| Renown | Title | Leadership | Re-rolls |
|--------|--------------------------|------------|---------------|
| 1-5 | Explorator Techpriest | 7 | 1 |
| 6-10 | Magos Errant | 8 | 1+1 refit |
| 11-20 | Magos Explorator | 8 | 2+1 refits |
| 21-30 | Aspiring Archmagos | 9 | 2+1 refits |
| 31-50 | Archmagos Explorator | 9 | 3+1 refits |
| 51+ | Archmagos Veneratus | 10 | 3+2 refits |

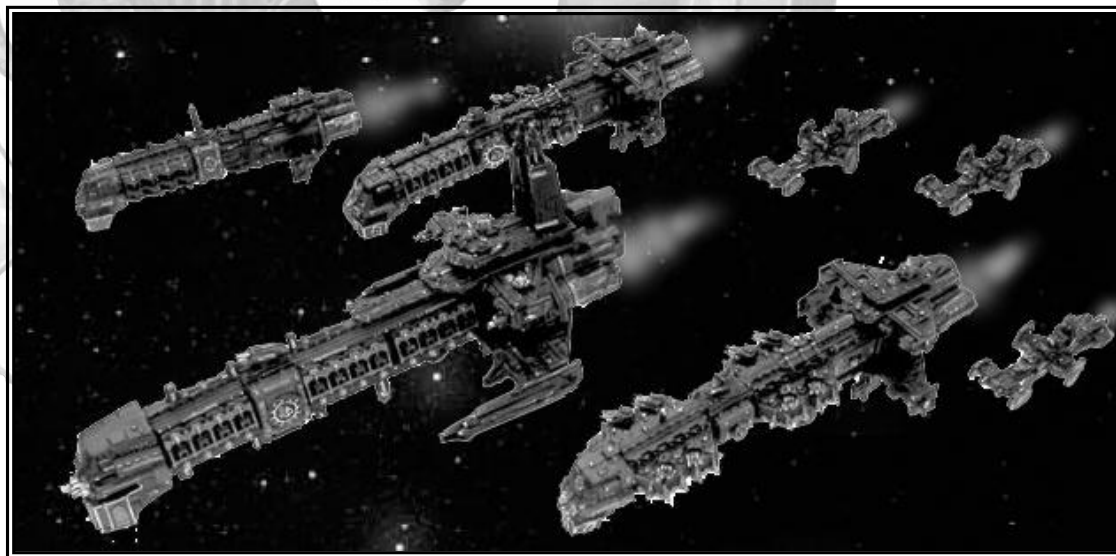

ADEPTUS MECHANICUS FLEET LIST

FLEET COMMANDER

0-1 Mechanicus Archmagos

You may include 1 Mechanicus Archmagos in your fleet, which must be assigned to a capital ship and replaces its Leadership with the value shown. If the fleet is worth 1,000 points or more, a Mechanicus Archmagos must be included to lead it. A Mechanicus Archmagos must be embarked on an Ark Mechanicus if one is included in the fleet.

Archmagos Explorator (Ld 8) 50 Points
 Archmagos Veneratus (Ld 9) 100 Points
 A Mechanicus Archmagos can elect up to any one desired item from the Adeptus Mechanicus refit table for their own ship as part of their point cost, in addition to (and before) the refit the ship rolls for normally. If the second refit rolled is identical to the one selected, the commander can select the second refit as well! The benefit a Mechanicus Archmagos brings with it cannot be combined with a refit selected because the ship rolled a 6 when determining base leadership, meaning in one-off games a ship will never have more than two refits from the Mechanicus Gifts table. If you wish to give a Mechanicus Archmagos any fleet commander re-rolls, you'll have to pay for them.
 One re-roll 50 Points
 Two re-rolls 125 Points

CAPITAL SHIPS

The Adeptus Mechanicus will only use warships from the following classes, applying all the rules described beforehand. The cost listed below replaces the original cost for these vessels found in the Rulebook or Armada when used as Adeptus Mechanicus ships. The *Omnissiah's Victory* may not take any Mechanicus Gifts refits, as its Mechanicus Gifts are

already included in its point cost and special rules.

Battleships

You may include 1 battleship for every three cruisers in the fleet.
 (0-1) *Omnissiah's Victory* 415 Points
 Emperor Battleship 400 Points
 Retribution Battleship 380 Points
 Oberon Battleship 370 Points

Cruisers

You may have up to fifteen cruisers in the fleet.
 Dictator Cruiser 255 Points
 Tyrant Cruiser 220 Points
 Lunar Cruiser 215 Points
 Gothic Cruiser 215 Points
 Defiant Light Cruiser 130 Points
 Endeavor Light Cruiser 125 Points
 Endurance Light Cruiser 125 Points

ESCORTS

You may have any number of Adeptus Mechanicus escorts in the fleet, taken from both the Imperial Navy and Space Marines fleet lists for the point costs listed below but otherwise unmodified from their normal profiles.
 Nova Frigate 45 Points
 Firestorm Frigate 40 Points
 Gladius Frigate 40 Points
 Sword Frigate 35 Points
 Falchion Frigate 35 Points
 Hunter Destroyer 35 Points
 Cobra Destroyer 30 Points

ORDNANCE

Attack carriers may use any combination of Fury interceptors and Starhawk bombers. They may not

use assault boats, even if their Imperial Navy counterparts may have access to this type of ordnance (such as Emperor battleships). Mechanicus vessels equipped with launch bays may also take torpedo bombers for +10 points per launch bay. All Adeptus Mechanicus capital ships that utilize torpedoes use ordinary torpedoes (not boarding torpedoes) and can be equipped with refitted torpedoes as described in their rules.



Strike the first rune upon the engine's casing employing the chosen wrench. Its tip should be anointed with the oil of engineering using the proper incantation when the auspices are correct. Strike the second rune upon the engine's casing employing the arc-tip of the power-driver. If the second rune is not good, a third-rune may be struck in like manner to the first. This is done according to the true ritual laid down by Scotti the Engineer. A libation should be offered. If this sequence is properly observed the engines may be brought to full activation by depressing the large panel marked "ON".
 - Imperial Navy Flight Manual W110E

FABRIC OF THE IMPERIUM

ROGUE TRADERS, WOLFPACKS AND THE MERCHANT FLEETS OF MANKIND



It is a given fact that through the might and valour of the Imperial Navy, the raging tides of foul aliens and vile heretics that infest the galaxy have been stayed from overrunning the millions of worlds that over the millennia have come under the Emperor's beneficent rule. While these hulking, powerful warships are the most notable representation of mankind's command of the stars, it is actually through the millions of humble merchant freighters, lumbering heavy transports and sleek fast clippers making up nearly 90% of Mankind's interstellar spacecraft that its vast domain is held together. Only a very small fraction of the incalculable worlds upon which the children of Man tread can truly be called self-sufficient. Most rely on a brisk interstellar trade for a steady stream of foodstuffs and raw materials to maintain their productivity and way of life. A vast majority of Imperial worlds may go decades or even centuries without a single visit from an Imperial warship. On the other hand, the sight of ordinary passenger liners and cargo transports in an infinite variety of types and patterns are a common occurrence in even the most remote frontier worlds. With the Navy constantly stretched thin defending its vast domain from grave threats from within, without and beyond, it falls to the slow,

ill-equipped and poorly-armed merchant vessels to keep the lines of commerce and communication open in a vast, uncaring universe filled with many grave dangers to both the bodies and souls of Man.

All merchant vessels are operated solely under the auspices and at the pleasure of the Imperial Navy, as it is rare indeed that the Navy lightly countenances private ownership of interstellar vessels. However, the Navy is far too busy to relegate its trained officers and crews to operating such craft. While the Navy does maintain a number of transports for its exclusive use, the vast majority of transport vessels that ply the stellar main are civilian-operated. This is expressed in the form of Charters, which grant varying rights and freedoms to the trade guilds, syndicates and merchant families that own and operate merchant vessels and fleets. These hereditary Charters are granted by the Administratum and registered through the Sgementum Fortress that holds authority over the vessel's intended operating area. Though they can be revoked at any time by Imperial authority, they are hereditary in nature and in some cases date back hundreds or even thousands of years. Nearly all of the more lucrative trade routes are also managed through route licenses, purchased by merchant vessel operators for unrestricted or even exclusive rights to handle shipping to a particular world, system or small group of systems. The most valuable (and expensive) of these govern operation over long-established and highly profitable routes between primary worlds, and it is not uncommon for several competing consortia to operate simultaneously on the busiest routes.

Route Licenses and their attendant fees, while usually effective for a hundred years but in some cases for far longer and even in perpetuity, can be wildly exorbitant and firmly out of reach for many smaller operators. Most are fortunate enough to acquire less profitable licenses to operate as Chartist Captains between the more sparsely populated

secondary worlds of the many thousands of sub-sectors scattered throughout the stellar main. Still other small corporations, mercantile families and individual Free Traders operate under charter but without a route license at all, forced to eke out a livelihood operating one, or at most a very small number of vessels for cargo manifests that come what may, heading to dangerous or remote locations in the hopes of generating enough income to recover the heady expenses of operating interstellar craft. If that were not enough, Chartist Captains at any time may find their ship and its cargo conscripted by an Imperial Navy task force needing logistic support or an Inquisitor or other such notable needing conveyance, a passing inconvenience considering they may just as easily blunder into a rampaging pack of Ork brigands, Eldar corsairs, alien pirates or the foul minions of Chaos, never to be seen again, befalling fates far more terrible than the grim comfort of mere death...

ROGUE TRADERS: THE GOOD, THE BAD AND THE UGLY

By a vast percentage, most merchant captains rarely veer far from their established transport routes plied over generations, reluctant to take on assignments chartist masters elect to remain where profits may be slim, but the course is well travelled and at least as

relatively free of danger as can be expected from the stellar void. There are a rare few however who after a time reject this meager existence, choosing instead to embark on grand quests through wilderness space to seek out new worlds ripe for colonization, to boldly go where no human has gone before. While many of these intrepid adventurers are never heard from again, the annals of the Imperium's long history is replete with stories of merchant captains and their crews coming across worlds teeming with indescribable riches beyond compare, lush virgin prairie worlds suitable for agricultural harvest, or worlds inhabited by man lost to the Imperium for millennia, ripe for re-indoctrination into the Imperial Creed as a ready workforce of willing servants of the Emperor. Still others bring back tales of encounters with alien races and strange new technology, rare and precious artefacts presented to the Adeptus Mechanicus for bountiful reward.

These brave souls with the courage and wherewithal to undertake such adventures and live to tell the tale are known as Rogue Traders. To limit the moral pollution caused by contact with alien and non-Imperial human cultures in millennia past, the Adeptus Terra outlawed trade and dealings beyond the Imperium. Only those individuals with Warrants of Trade or similar documents are allowed to explore planets not yet under Imperial control, encounter

alien civilizations and regressed human societies, and claim barren worlds rich in minerals or other resources. Typically these are awarded to retired Naval officers, scions of noble families and the like, sometimes on the condition that a mission of particular import be undertaken with the Warrant as its reward. Operating beyond Imperial control, they are a law unto themselves. Some are highly pious individuals, bringing the Emperor's light beyond his beneficent rule. Others are nothing more than glorified pirates and scoundrels. Not all who claim to be Rogue Traders actually are; many Warrants of Trade are centuries old – handed down through family generations, exchanged in high-stakes gambling dens, stolen from rightful owners or have otherwise fallen into the hands of those who might abuse the power they bestow. Despite their generally well-deserved shady reputations and colorful personal histories, Rogue Traders as a whole have done much to advance the influence of the Imperium. Individually they have been known for various idiosyncrasies and excesses not normally tolerated by the more stringent Ordos. As they provide a priceless resource of information outside normal channels for agents of the Inquisition, these are normally tolerated to an extent, and in some cases even condoned by willingly blind eyes.

Rogue Traders exude confidence; they are highly charismatic, often charming and roguish, skilled diplomats (some would say confidence tricksters) and hardened killers when the situation demands. Rogue Traders will often gather an entourage of hangers on and companions much like an Inquisitor does, and this may contain alien warriors, mutants and other undesirables, which many Inquisitors would take to marking the Rogue Trader out as a heretic. Many Rogue Traders have highly unstable personalities; some have been known to destroy worlds on a whim or experiment with alien species out of macabre curiosity.



Rogue Traders often dress extravagantly and flamboyantly; like Inquisitors each one has their own style and manner. They carry the best weapons and equipment they can acquire, including all manner of alien weapons and gadgets. Jokaero digital weapons are popular; miniature lasers and needlers that are worn as rings but contain the same power as a pistol. They might be carrying C'tan phase weapons that can bypass armor, Ha'Kaidan neuro-stars, or one of a million other pieces of strange and bizarre wargear.

It is not uncommon for a Rogue Trader to have once been a high ranking member of the Adeptus Terra, perhaps ousted from power and falling back to trading and using his or her contacts to regain their position and authority. Such Rogue Traders often wear the finery of Imperial aristocracy mixed with garments from worlds beyond the Emperor's rule, often sporting a weapon from military service such as a Naval cutlass or Officer's sabre. They might also carry ornate dueling pistols in lacquered holsters, ancient looking hunting rifles slung rakishly across the shoulder, or other such items that are as lavish to behold as they are deadly effective weapons.

ROGUE TRADER FLEETS

Rogue Traders travel by a variety of means – as passengers aboard military vessels or as the guests of distant, non-Imperial cultures, but most of all they enjoy the freedom to travel of their own free will. They must journey vast distances, and hence they are granted the right to maintain their own vessels, and on occasion entire fleets numbering up to several dozen or more starships. As befits their maverick nature, Rogue Traders employ an incredible variety of vessels. Rights of Requisition allow Imperial Navy ships, while others use their vast wealth and power, and other dubious means, to acquire vessels from a variety of sources – custom-built ships, refitted merchant vessels, captured ships or even craft acquired from non-Imperial worlds. Rogue

Trader vessels are unique, exotic things, often exhibiting many signs of their colorful histories, subject to constant adornment, much of it ancient or even alien in origin.

Though their business is their own, from time to time a Rogue Trader may be accompanied by, or even granted command of, an entire fleet at the behest of the Priesthood. On such missions a Rogue Trader's authority is all, beyond the bounds of the Imperium where any could bring censure to them and in places so alien, so unknown that their uncanny leadership must be followed to the letter if any of their number hope to survive. Likewise, though a Rogue Trader himself maintains no army, he may well be granted Imperial Guard or even Space Marine forces, if it is felt that his mission warrants it. On such occasions the Rogue Trader will turn his business to battle, leading the armies of the Emperor to worlds unknown, bringing war to the enemies of Mankind, even beyond the reach of the Imperium itself. Very few Rogue Traders do so altruistically however, for even in war or death a canny Rogue Trader will find profit and prize.

LUKURIUS VANLESSA AND THE LOOT OF A THOUSAND WORLDS

Sometimes a consortium of several especially wealthy Rogue Traders will organize an expedition into wilderness space with Imperial sanction, usually with the support of the Adeptus Mechanicus. More often than not these run into trouble that is far above and beyond its worth, and little (if any) profit is made from the venture. Occasionally though such expeditions encounter unimaginably vast riches and opportunity for wealth, and even after the Navy and Mechanicus assess exorbitant fees and charges for their support, a tidy sum still remains to be had. While such tales abound in history and lore, none is more spectacular than that of Lukurius Vanlessa. While leading a fleet of eleven ships, the heavy transport *Santissima Terra* captained by Ingio

Portfell became separated in the warp and re-entered real space in an uncharted system on the Eastern Fringe. A quick survey revealed a volcanic death world of absolutely incomparable riches near the Mercurial Zone, with fist-sized rough diamonds simply littering the surface along vast, exposed veins of gold, platinum and other treasures. Over the course of four months, Portfell flew his cargo shuttles to destruction to fill his ship to capacity with gems and precious metals, resorting to cladding the exterior of his ship with gold and platinum when the holds were full. So in excess was the mass of this vast treasure that the ship required a week of successively higher orbital swings just to break free from the planet's gravity. Afraid to send any message even by astropath, it was more than another two months before they were able to re-join their fleet, which had suffered badly during an encounter with Ork pirates. Betrayed by traitors who made off in one of the fleet's escorts, Lukurius Vanlessa led a valiant struggle over the course of four years to lead his ragtag, harried and always under-gunned fleet, sometimes remaining in hiding for weeks on end orbiting remote backwater worlds with all systems shut down to avoid detection from prowling renegades and pirates of every stripe. Even an attempt to sanction aid from the Imperial Navy proved disastrous when a cruiser captain betrayed the flotilla in a play at capturing the *Santissima Terra* for himself. When the flotilla finally broke through to Terra, this time under heavy guard from every vessel that could be purchased or contracted by their guild house, Ingio Portfell still took no chances. In an unbelievably daring move, he landed the heavy transport on the hereditary lands of the guild, nearly destroying part of a city despite effecting a soft landing that left most of the vessel intact. Even after all fines, fees and other recompense was made, the guild house was so enriched by the vast hoard recovered that its stature and wealth was elevated to that of even the greatest conglomerates in the entire Imperium, ranking even among those of the vital

Corporate Sector. It is said that to this day, buried somewhere among the sprawling cities of Vanlessa Hive on Terra, much of the hull structure of the original Santissima Terra remains.

LIVING THE ADVENTURE: THE EXPLOITS OF SIMONIES KNOCKE

While undreamt-of riches can be found in the depths of space, treasure quests in their various forms are not the only way (or even the most common way) to make a lucrative profit in the void between the stars. Many Rogue Traders that by chance or necessity acquire one or a small number of armed vessels find themselves now and again hired not for the capacity of their cargo ships but for the aim of their guns. With the Navy stretched as thin as it is, it is not uncommon for more reputable Rogue Traders to be taken under contract to escort transport convoys through wilderness space, taking an escort squadron in tow detailed from regional fleet authority while freeing capital ships for more pressing duties. Others may function as privateers, operating with a Letter of Marque to harass enemy shipping behind the lines, once again freeing regular Navy units for active combat operations. Some Rogue Traders develop quite a knack for this kind of work, and a few rely almost exclusively on it to cover their expenses and earn a profit.

Simonies Knocke was renowned for his loyalty and courage from the Eastern Fringe to the border worlds of Segmentum Obscurus, and after a short stint as an explorer and transport vessel operator, he amassed a vast fortune as a hired gun for the various trade guilds that operate the lucrative Laurentina-Heraklion route. It has been speculated by some that he pre-arranged much of the Ork activity that harassed shipping lanes in the system along the route less than two years before he became renowned for his convoy escort services, though this is for the most part dismissed as little more than disparaging slander by envious competitors and guild houses

unwilling or unable to meet the stiff fees for his services. What brought him Inquisitorial attention however were not his activities in this regard, but his association with an alien race Ordo Xenos records identified as the Pthuxutl.

While aboard his light cruiser *Knocke Bootës*, the Rogue Trader expedition he was accompanying was caught in a fierce warp storm near the Hell-Stars of the Garon Nebula in Segmentum Tempestus that foundered and destroyed most of the fleet. After a valiant struggle that killed his best Navigator, his ship was tossed back into real space with only two transports, two of his own escorts and a single Firestorm frigate in attendance. They came upon a previously undiscovered system and blundered into a firefight between Ork raiders and an unidentified Xenos fleet of escort-class vessels. The battle was going poorly for the strange aliens, and the remains of Knocke's fleet was in no condition for battle, but they were discovered by the Orks before they could make good their withdrawal. With the only option for survival being in a hasty alliance at the end of a gun with the unknown Xenos and unable to even communicate his intent to them, he maneuvered his tattered flotilla behind the alien escorts and fired into the Ork fleet. Together they were able to defeat the Orks, and Knocke was able to forge the unlikely partnership into a lasting one.

Continuing contact revealed this race to be called the Pthuxutl, a race of traders that while warp-capable, did not have any interest in extensive colonization and appeared content to subsist as nomadic traders. In gratitude for his support, Knocke was welcomed to accompany them long enough to effect full repairs of all his remaining ships, and he invited the aliens to detach a number of their vessels to join his fleet. In successive decades, Knocke has expanded his fleet to include two full cruisers, all it is said from profits gained almost entirely on his various convoy-escorting enterprises. While he has a number of quite powerful ships at his disposal, it is extremely rare to

ever see him abroad without at least two or three vessels of the Pthuxutl accompanying his starships.

WOLFPACKS- FROM PRIVATEER TO PIRATE

The difference between a privateer and a pirate is sometimes only in the eye of the beholder, and as often as not Rogue Traders are little more than pirates that manage to keep getting away with it. On occasion these individuals will take on contracts to harass shipping not from competent authority, but from a rival shipping magnate or other interested party. While such operations are patently illegal, the floating debris of blasted hulks tell no tales, and it can be years or decades before such privations are brought to the attention of the Imperial Navy. Indeed, the best means by which to draw near their intended targets is in the façade of decency. Roguish privateers may well and often do engage in sanctioned, lawful activity as the mood takes them, only to use the freedom of movement this gives them to expand their raiding activities. The Tau in particular are masters of such duplicity, and many a human Rogue Trader has heeded well this lesson and taken it onboard for his or her own after furtive dealings with this mendacious Xenos race, taking on letters of marque from them to attack, cripple and claim bounty from any vessel they can find for reward and protection from their so-called "commerce protection fleets." However, many Imperial agents with little contact with the Tau behave little better, and outright piracy visited upon each other between merchant families and trade guilds is certainly no rare thing. These activities can also be good for business; a carefully-orchestrated "attack" on merchant shipping interrupted by the timely arrival by a Rogue Trader cruiser with its guns blazing can do much to generate contracts for escort and protection by grateful transport guilds and vessel owners.

By the very nature of their business, pirates must stalk near to their prey's most common haunts. The immeasurably vast, desolate void of space offers little to a pirate who chooses simply to wander blind through it in the hope of coming upon some potential target entirely unawares. Such a pirate will almost certainly find nothing at all and be as unsuccessful as a lone predator in a barren wilderness. However, to simply prowl brazenly through the richest of hunting grounds – the bejeweled docks and ports of the most vibrant trading regions – would invite nothing more than swift destruction by the guns of the Imperial Navy. So it is that like the foul Xenos raiders they emulate, pirates must be cunning and come upon their intended targets at their most vulnerable.

Sometimes the quest for profit and adventure takes a dark turn. On the opposite extreme of cunning rogues who engage in piracy only by contract or when the opportunity presents itself, there are the opportunistic wolfpacks who stalk cargo-laden merchant vessels at all the most vulnerable points of their journey. There are recorded instances of Rogue Traders bending individual ships or even their whole fleets toward purposes that are not in the interest of Mankind. Casting off their sacred vows of duty and service to the Imperium, they freely hunt down and capture any hapless transport convoy that may come their way, sharks hungrily prowling well-traveled routes to plunder transports, keeping or selling off their cargoes and crews as booty, slaves or worse in a manner emulating such infamous Xenos pirate

scum such as the inhuman Eldar raider Yriel or the notorious and savage Jolly Ork freebooter Grubsnikk. Human pirates have an advantage over Xenos reavers in that they can easily emulate their prey, unlike the strange, alien forms Eldar vessels take or the cumbersome, rattletrap and easily-identifiable attack ships favored by the Orks. Particularly unsavory characters hide under the guise of being Rogue Traders only as a ruse, assuming the title of such an august personage under dubious (and typically illegal) means simply as a cover for their primary "trade." Such Rogue Traders no longer deserve the title, subsisting solely as pirates and gathering around themselves a ragtag fleet and whatever Xenos they can ally themselves with. Such vermin are little more than a pack of raiders skulking

ORDO XENOS DOSSIER: THE PTHUXUTL

The Pthuxutl hail from a remote system in Segmentum Tempestus extremely difficult to reach via the warp. They are fiercely isolationist, and by nature they are extremely reclusive and prefer to completely shun contact with other races. Despite this, they have made themselves known to the Imperium of Man, and it is only by subtlety, their relatively unimpressive level of technology and the limited threat they represent that they have managed to escape close Imperial scrutiny. Until encountered by the Rogue Trader Simonies Knocke, it is widely believed that their only contact with other races has been with the Orks, with whom they maintain a nearly incessant state of conflict. It is speculated by some that they have had or currently maintain contact with both the Demiurg and the Eldar, though this has not been confirmed.

While they refer to their combat vessels by a term that roughly translates to "space cruiser of war," their largest warships are in a displacement range similar to most Imperial frigate classes. Continuing Ork raids have fostered a siege culture among the Pthuxutl, and they maintain a significantly large number of these vessels throughout their home system. Their ships are nominally warp-capable, but they rarely venture out into the greater galaxy beyond the small number of systems they inhabit, typically using small flotillas of their war-cruisers on patrols against threats their homeworld may face. This has increased significantly since encountering Imperial Rogue Traders, which may be an attempt by them to determine the sphere of influence of Mankind's domain. They have been known on occasion to provide their services to Rogue Traders as particularly effective "flak escorts" protecting against enemy ordnance, and the Rogue Trader Simonies Knocke in particular retains a number of their unique and strangely designed vessels as a permanent part of his fleet. The Adeptus Mechanicus has expressed a passing fascination for these vessels, but as they possess no new technological advances of real significance, demand for them has not proven lucrative enough to warrant an expedition to capture more.

A detailed survey of a Pthuxutl "war cruiser" revealed that while they possess a unique disruptor cannon as their primary weapon, it is complex and inefficient when compared to Imperial plasma lance designs of similar range and destructive power. However, their attempts to counter Ork attacks resulted in a turret design fully integrated with its primary laser batteries that is the most comprehensive ever encountered in a vessel of its displacement. It is speculated that based on their level of technology, this particular system may have been developed with unknown Xenos influence.

PTHUXUTL WAR CRUISER – 50 Points

| TYPE / HITS | SPEED | TURNS | SHIELDS | ARMOR | TURRETS |
|------------------|-------|-------|--------------------|-------|--------------------|
| Escort/1 | 25cm | 90° | 1 | 5+ | 3 |
| ARMAMENT | | RANGE | FIREPOWER/STRENGTH | | FIRE ARC |
| Weapons Battery | | 45cm | 2 | | Left/ Front/ Right |
| Disruptor Cannon | | 30cm | 1 | | Front |

Notes: The Pthuxutl disruptor cannon is an inefficient and cumbersome but easily-duplicated weapon system. It functions as a standard lance in all respects. Pthuxutl war cruisers cannot be used in any fleet allied with the Orks.

from the dark corners of remote systems, seeking only to pillage all those unfortunate enough to cross their path. Unfortunately, many Xenos races flock to such disruptions as flies to carrion, and it is quite common to find human pirates operating in close association with one or even several Xenos races acting in concert.

Ships translating from warp must do so in deep space, for to do so within the confines of a system is unimaginably hazardous for all but the most skilled pilots and navigators. From these far reaches they must follow a long journey fraught with risk to the destination planet or outpost, the entire time at sub-light speed, and it is during this time that wolfpacks frequently strike. The vagaries of the warp can lead to a merchant convoy and its armed escort (if any) emerging from the warp some time apart. Indeed ships within the same convoy may re-enter real space anywhere from minutes to hours apart in normal space-time, and if caught undefended in this manner, merchant vessels will prove easy pickings for roving pirates. Likewise, ships are only able to enter the warp with any degree of safety some distance outside systems, and routes leading from manufacturing worlds, mining colonies and other sources of great wealth to the nearest warp gate are tempting targets to most pirates. Commensurate with that, such routes are usually heavily defended, but as with all resources, the protection of the Imperial Navy is an expensive luxury which the badly overstretched Imperium cannot afford to offer all. Many places of mineral or other material wealth lie

in the loneliest and most desolate regions of the galaxy, and without nearby colonies to supply men or provide a genuine need for security, many of these distant mines, colonies and outposts must fend for themselves. Here too privateers profit, and pirate may well turn protector if the merchant families operating the shipping lanes or the guilds operating the mining worlds, manufactorums and refineries decide it is in their interest to employ the would-be raiders rather than face them.

Even having safely made it to warp and once under sail, merchant vessels are far from safe. Locating other starships within the warp is exceptionally difficult, and few pirates would attempt to unleash their ambushes amidst the hideous, roiling confusion of the immaterium, but few ships are able travel directly to their destination via the warp. In many cases a viable warp route simply will not exist, and ships must translate to real space and travel some distance through connecting regions of space, perhaps many hundreds of light years from their destination in order to avoid some of the greater vagaries of warp travel. Where such departure or transit points become known, pirate wolfpacks inevitably flock to them as flies around carrion.

RESPONSES TO PIRACY

By their very nature, pirates risk defeat and capture with their every action. Space is a vast gulf where billions of cubic miles of space lie undisturbed by even a single speck of matter. Pirates cannot simply

roam through this void in search of prey; they must lurk close by the haunts of their targets and wait there ready to strike. What this means is that pirates must, for the most part, linger in a region for many months or years, and once pirate activity is noted in an area, the Administratum can be almost certain the threat will remain for quite some time to come. Under such conditions, pirates and those who would seek them out and destroy them are constantly engaged in a dangerous game of brinkmanship with gutsy pirate captains remaining in a lucrative region for as long as their possibly can all the while aware that dallying there too long may well allow local forces the time they need to muster and defeat them.

Pirates cannot be dealt with as soon as their presence becomes known, however. The galaxy is a dangerous place, and piracy is far from the greatest threat faced by the societies which occupy it. Pirates may operate relatively undisturbed for considerable lengths of time if war or a greater or more urgent threat continues to occupy available forces nearby. Conversely, however, pirate activity cannot be overlooked entirely, even in times of war, since to do so invites disruption and breakdown, the like of which could very well prove fatal to even the largest of forces. Again, it is a contest. The wildest pirates know full well that limiting their predations can keep the eyes of their enemies averted, but in doing so may well limit their own ambition. The opposing forces must also attempt to maintain a risky balance – valuable fleet and army assets must be used where they are most needed, without allowing apparently



minor threats like piracy to escalate to the point where piracy itself becomes the greatest threat. This was especially apparent when the disarray caused during the Accursed One's 12th Black Crusade made the entire Gothic Sector particularly ripe for plunder. Pirates of all kinds crawled out from every moonlet and hole in space to take advantage of the precarious situation the Imperial fleet found itself in at the start of the war. To make matters worse, a few Imperial units assigned to some Rogue Traders willingly threw in their lot with their charges, not in any support for the Chaos hordes that assailed the sector, but purely for personal gain at the expense of others. At first these pirate scum limited their predations to the occasional single transport or remote monitoring station, but as the war dragged on, even the most heavily trafficked trade routes went without military patrols for longer and longer periods of time. Soon individual pirates and renegade captains began to form small bands and then even larger groups, each lending to the cause only as long as it was to each own's personal advantage. These raiders held allegiance to no one and freely hunted the ships and convoys of anybody and everybody. Only a dedicated search and destroy campaign by a large battlefleet led by Admiral Mourndark was able to set a trap for and root out the worst of these scourges, at one point engaging and destroying three pirate cruisers and over fifty raiders during a single battle in the Barbarus Costa system.

To prevent piracy from becoming so widespread that it impedes a war effort or threatens to destabilize an entire region of space, threats are monitored by a

series of Sector Stabilis Mandates which define at what point a threat becomes so great it must be dealt with. When used effectively, these mandates become a trigger mechanism by which the most prominent and dangerous of pirates are dealt with, both eliminating the problem and serving as warning to aspiring troublemakers in a region. Under the Sector Stabilis Mandates, separate attacks from different sources increase the sector's threat level only minimally, since a sector may well be assailed by a variety of smaller enemies, such as a cluster of alien races around its borders, without its stability really suffering (as long as those enemies themselves do not unite, that is). Repeated or coordinated attacks thought to be the work of a single group or alliance are used as a factor of multiplication when calculating threat levels, and so pirates responsible for multiple attacks are far more likely to find themselves brought to the attention of the authorities than those whose strike only irregularly or without a coordinated plan.

Threat levels are measured in both degree and urgency, so certain factors may mean a relatively minor threat has to be dealt with immediately, while the tackling of other, seemingly much greater, threats may safely be delayed until proper preparation is made. When a threat exceeds the maximum level of tolerance prescribed by that own sector's Stabilis Mandate, action must be taken. Of course, individual commanders, planetary governors or other officials can act within their power well before this point, but are certainly not obliged to do so. Once the maximum threat level is exceeded,

however, there are few servants of the Imperium who can ignore the call. Indeed, only the Adeptus Astartes and the Inquisition are entirely free of standing obligations in the Mandate.

Even once a decision is taken to tackle a particular nuisance, responses will of course vary. Some regions will simply be granted increased patrols in light of privateer activity, while in more serious cases a battlegroup may be assembled with express orders to hunt down the pirates and undertake no other duties until they have done so. Even with such steps as these to tackle piracy, it remains the case that most privateers find their ultimate end to be of their own doing. Cocky rogues become reckless or greedy, preying upon targets far beyond their means to overcome, or wantonly attacking the Emperor's forces to prove their might. Others find themselves the slightly unfortunate, if not undeserving, victims of mishap or ill timing. Privateers taking advantage of a strife-ridden area of the galaxy (perhaps engulfed in war or fallen under the shadow of an encroaching hivefleet) frequently find themselves swept away alongside their intended victims as events quickly escalate and attract vast forces, a foe well beyond the measure of even the mightiest privateer.

For all its risk, it goes without saying that the galaxy is rife with pirates, both human and alien. While the reasons men and women with the wherewithal to command starships turn to piracy are as varied as pirates are themselves, in the end the lure of easy wealth becomes the largest motivator. Even the mightiest and most steadfast of Mankind's defenders are not immune to its appeal. It is only natural for the Emperor's subjects to hold Space Marines with a mixture of awe and fear. With a powerful warship beneath a Space Marine's feet and nothing in between its Captain and a hapless transport convoy but empty space, it is not unknown for protectors to become predators, and in the Imperium's long history, more than one entire Space Marine Chapter

"We fell upon them like hounds at the chase. They tried to scurry and bolt for their holes, but my escorts were ready for them. The Cypra Probatii herself claimed fifteen kills that day and their losses must have been in excess of thirty ships in total. Many fled to the surface of Barbarus III, thinking themselves safe from our guns. How wrong they were. Using plasma torpedoes modified by Magos Urilun of the Adeptus Mechanicus, we set fire to the atmosphere of the near-deserted world, burning them out. Only three vessels emerged from the conflagration, asking for clemency. Our guns showed them the mercy of the Emperor!"

-Fleet-Admiral Mourndark after the Battle of Barbarus III

has descended down this path. Once Master of the Astral Claws Chapter of Space Marines, Huron Blackheart turned against the Imperium and declared himself Tyrant of Badab, his Chapter's original homeworld. The resultant crusade against him began badly for the Imperium, as a further three Chapters defected and took up with Huron. Retaliation was swift, though at first it was all the Imperial Navy could do to maintain the shipping lanes upon which Huron and his traitor Marines had begun to prey.

Huron was strong, and with four entire Chapters behind him, the Imperium faced a long hard struggle to bring him down. But even Huron could not match the might which was brought to bear against him and eventually he was driven from Badab, where he and his followers fled into the nearby Maelstrom, a convoluted, swirling area of gas, dust and titanic energies hundreds of light years across, where the warp and the material universe intermingle in a manner not unlike the Eye of Terror. Many of those Marines who had sided with Huron during the uprising realized the error of their ways and returned to the Emperor's fold (albeit with much penitence to serve). There were, however, many who remained disgruntled with the Imperium and joined Huron in his flight into the Maelstrom. With his homeworld lost, Huron and his Astral Claws obliterated all traces of their former allegiance, covering their armor with a gruesome red hue to hide the symbols of the Emperor they once served, becoming the Red Corsairs. Since that day Huron and his Red Corsairs have continued to prey upon shipping lanes, commerce worlds and other wealthy regions around the Maelstrom. Clearly some considerable allure still surrounds Huron, and bands of human reavers still continue to flock to this flag, bolstering his corsairs. More worryingly, it would appear that members of the Adeptus Astartes still continue to defect to the Maelstrom to take up a place at Huron's side. Small bands or even individual Marines have all been known to turn and take up with Huron, symbolically reddening their armor to assume the Blackheart's

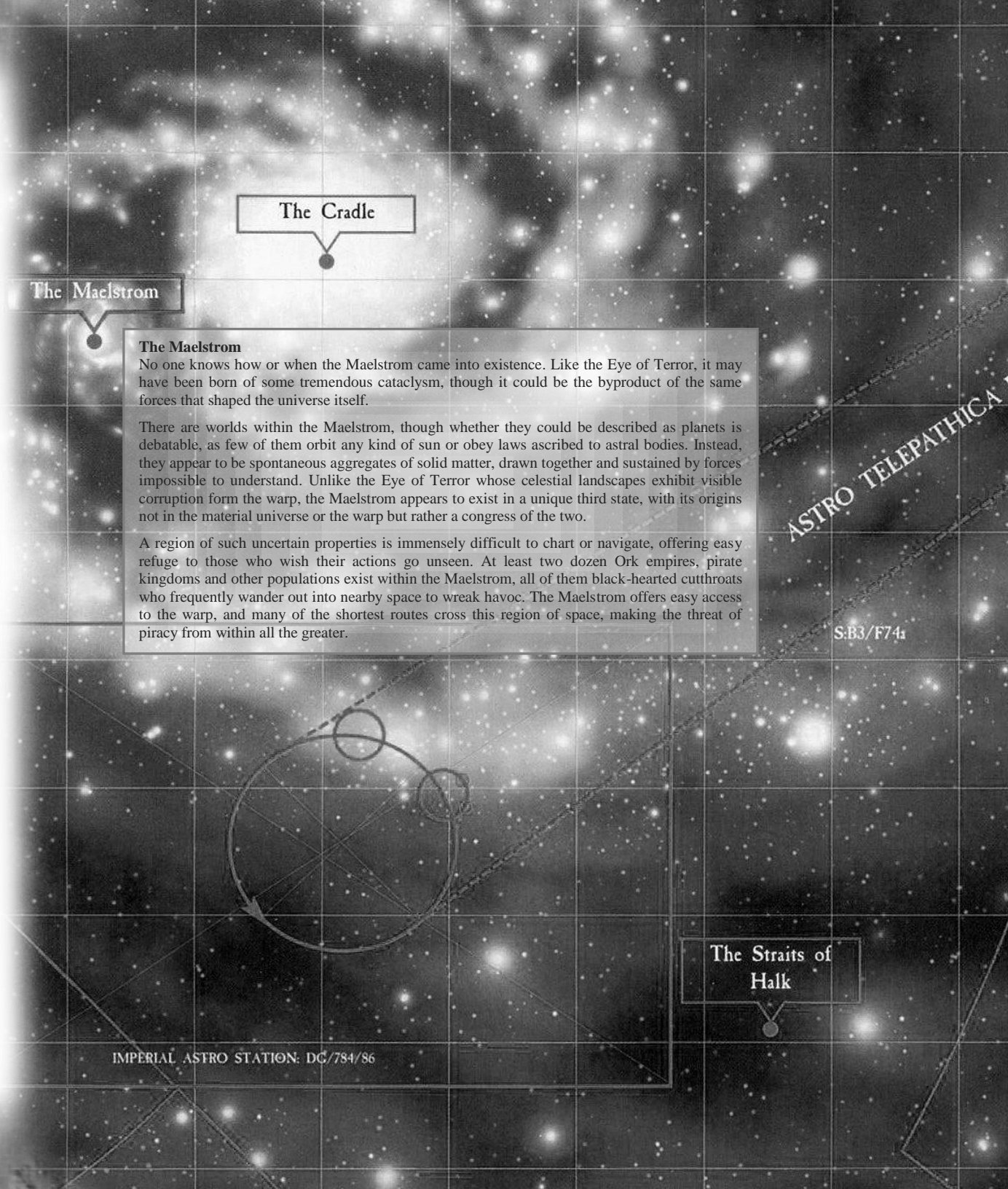

The Cradle

The Maelstrom

The Maelstrom

No one knows how or when the Maelstrom came into existence. Like the Eye of Terror, it may have been born of some tremendous cataclysm, though it could be the byproduct of the same forces that shaped the universe itself.

There are worlds within the Maelstrom, though whether they could be described as planets is debatable, as few of them orbit any kind of sun or obey laws ascribed to astral bodies. Instead, they appear to be spontaneous aggregates of solid matter, drawn together and sustained by forces impossible to understand. Unlike the Eye of Terror whose celestial landscapes exhibit visible corruption from the warp, the Maelstrom appears to exist in a unique third state, with its origins not in the material universe or the warp but rather a congress of the two.

A region of such uncertain properties is immensely difficult to chart or navigate, offering easy refuge to those who wish their actions go unseen. At least two dozen Ork empires, pirate kingdoms and other populations exist within the Maelstrom, all of them black-hearted cutthroats who frequently wander out into nearby space to wreak havoc. The Maelstrom offers easy access to the warp, and many of the shortest routes cross this region of space, making the threat of piracy from within all the greater.

ASTRO TELEPATHICA

S:B3/F74

The Straits of Halk

IMPERIAL ASTRO STATION: DC/734/86

colors. Why a traitor and a renegade like Huron would appeal to so many of the Emperor's most righteous servants is, worryingly, unexplained.

It is an unspeakable enough a crime to eschew one's vows for personal gain, but this is not the worst offense a pirate can commit. The absolute worst offenders are those who truck with heretics and traitors, freely allying themselves with the minions of Chaos, preying on Imperial shipping of any sort not merely for profit, but to actively bring harm to the Imperium and its citizenry. While the allure of Chaos is as varied as the many men and women who fall under its shadow, the typical pirate turns to Chaos for the same incentives that motivate all such immoral villains: greed. Even the most casual alliance with a Chaos Lord brings with it relatively quick access to replacement escort raiders, reinforcements and supplies. Such wolf packs quickly find the Swords and Cobras among their number quickly supplanted by escorts more typical of Hereticus fleets, along with advantages in speed and weaponry that only come by dabbling with warp-tainted, forbidden technology. This was especially prevalent during the Gothic War, where a number of pirate bands such as the Carrion Squadron freely allied themselves with Chaos in order to more easily facilitate their raids against merchant convoys supporting the war effort. Thankfully these scum who turn their back upon the trust provided them by the Imperial Navy and the rest of Mankind to serve the Dark Powers are believed to be few and far between. When identified, they are mercilessly hunted down and destroyed with maximum prejudice by whatever resources can be arrayed to the task.

XENOS THREATS

An unknown number of nominally space-faring alien races in the immeasurable void between the stars survived the righteous pogroms of the Great Crusade when the Horus Heresy postponed the beneficent Emperor from his most holy work. This is especially

true along the remote systems of the Eastern Fringe and Northern Rim where the distances involved make it extremely difficult to detail warships of the Imperial Navy in any significant numbers from much more pressing concerns. Certain intelligentsia of the Explorator Biologis has postulated that not all sentient Xenos species encountered by the Imperium represent a threat, but prudence dictates based on long, grim history that no chance can be taken, nor any quarter given.

It is true that some encounters with alien races have resulted in mutual gain to a limited extent. However, whenever possible, every single one of these instances have been carefully examined by the Ordo Xenos to ensure there is no contact with forbidden technology, nor is any of humanity's blessed technology transferred to those who may one day use it against them. This becomes particularly important where contact with alien races is sanctioned by the Inquisition on a limited, conditional basis. In the region of space referred to as the Cradle, contact with the reticent Demiurg is almost unavoidable, but they have shown an unusual pacifism around Imperial ships and have even allowed themselves to be contracted against the enemies of humanity on occasion, particularly against the foul Orks, against which they show particular utility. This is tolerated merely because the Adeptus Mechanicus dearly seeks to obtain an example of their vessels, an opportunity that so far has not availed itself. Even in this case contact must be maintained only with careful awareness; long experience with the major alien races that occupy Imperial space have demonstrated that they can only be met with vigilance and hostility. Eldar raids can only be met by increasing security patrols in a given region of space, since only a fool would actually attempt to hunt down or pursue such a swift race. Orks, conversely, are normally dealt with somewhat more directly, since their brutish nature allows them to be confronted more easily. Indeed, often Ork pirates raid convoys primarily with the intention of drawing

nearly forces into a decent scrap. Even the Demiurg with all their relative indifference to humanity is not entirely blameless. It is well documented that they share a unique and well-cultivated relationship with the Tau, and it is not too farfetched an idea that the same Demiurg ships contracted to accompany an

The Cradle

The Cradle is a gargantuan, seething nebula deep within the galactic core. It is so known for the prolific rate at which the nebula births new stars, making the region one of the most densely populated with stars in the entire galaxy. The astronomical energies and gravity fields at play here make the Cradle one of the richest sources of precious metals, ores and forms of energy anywhere in the galaxy. Because of this, it is certainly no coincidence the Cradle is virtually the only area of human-controlled space from which the Demiurg are frequently reported, that race being expert and insatiable miners and harvesters of the universe's resources.

For other races, not least the Imperium itself, the Cradle is a vital resource, and many of the galaxy's most lucrative trade routes are found in this region. Though heavily defended and patrolled, it is not without risk, however. The vast quantities of matter present there mean the call of the warp is weak, even to the most sensitive Astropaths. Vessels may become becalmed for weeks or even months while their Navigators search for the faintest of warp tides on which to set sail. A ship is in great danger when this happens, for it is forced to spend a great length of time in normal space traveling at only sub-light speeds. All manner of pirates lurk around the Cradle's most lucrative mining and fuel production systems, ready to pounce upon becalmed vessels forced to travel in normal space before taking their booty and withdrawing to the depths of the nebula, where rampant energies make sensory detection unlikely.

Imperial task force one year will have any compunctions against selling whatever information they glean to that upstart race the next.

The galaxy is strewn with minor alien races that at one time or another have lured the occasional Rogue Trader into dealing with them for mutual gain or profit without proper guidance from the Ordo Xenos. More often than not these arrangements are ignored, for it is few and far between when a previously-unknown Xenos reveals itself to be of any significant threat to the Imperium. Unfortunately, despite endless centuries of vivid lessons concerning how an unknown Xenos should be approached, there are Rogue Traders who look upon these serious concerns for mankind's safety with disdain and even outright contempt. Some Rogue Traders fully throw in their lot with these real or potential enemies of Mankind, offering aid and assistance to foul Xenos races for little more than access to alien trade routes and the promise of riches and forbidden archaeotech. For instance, the Rogue Trader Darius Pluto aboard the *Route Less Apparent* surrendered his allegiance to conspire with the Fra'al, betraying to them critical details concerning Imperial convoy routes, schedules and escorting force strengths. For many years he operated with these vermin before he was run down and eliminated by a punitive expedition led by the Emperor battleship *Divine Right* in the Tamahl Sector in 518.M37. Before his demise, it is documented that he often accompanied small wolf packs of Fra'al vessels on raids against remote outposts and transport convoys, purposely destroying all escorting vessels before plundering every transport one by one. The damage done by this rank perfidy goes far beyond the actions of one mere person; many centuries after the destruction of the *Route Less Apparent*, Fra'al raids continue throughout an ever-widening area in Segmentum Obscurus at a pace that shows little abatement.

ORDO XENOS DOSSIER: THE FRA'AL

Unlike a great many minor alien races that plagued Mankind throughout the galaxy during the Dark Age of Technology until purged during the Emperor's Great Crusade to liberate Mankind, the Fra'al managed to avoid the Emperor's attention and remain in relative obscurity. Some have speculated that their system's proximity to the Eye of Terror is the primary reason for this. It is unknown exactly where their system or small cluster of systems are located, the only fact that stays them from the Emperor's wrath. While many of the Ordo Xenos and Ordo Biologis have debated where they may originate from, the fact that they tend to cluster their raids in the Artemis, Tamahl and surrounding sectors bordering the eastern quadrant of the Eye Of Terror suggests that they must originate from somewhere nearby. Rumors persist however that occasional Fra'al sightings have occurred as far away as the Northern Rim and along the border of Segmentum Ultima, though these have not been adequately substantiated.

Precious little is known of this Xenos race, as every single contact with Imperial elements, regardless of how benign, has resulted in combat until one side or the other was destroyed or forced to withdraw. Believed to be warp-worshippers like the Xenarch, every fact gleaned on this violently reclusive race was gained by extensive analysis of the blasted hull of one of their exceedingly rare capital ships identified in their guttural dialect as the *Sharak-Fraka*, hulked by the *Divine Right* during the battle of Fraga'Tral in 312.M39. Analysis revealed little in the way of technology that surpasses comparable Imperial designs, though rumors persist that the Adeptus Mechanicus was not entirely forthcoming with the results of their examination.

One remarkable trait is their seeming attraction to wildly asymmetric designs and configurations. Even their largest starships bear no symmetry along any axis, constructed utilizing a bizarre series of intricate patterns maddening to behold by even the most stoic of veteran starship crews. It has been speculated that these unusual shapes are somehow attuned to the warp, which has been postulated as an explanation for how they can so easily slip away from pursuers even in the midst of a heated engagement. This foul Xenos has been declared Horrificus Abomini by the Ordo Xenos, and it is only a matter of time before it meets its end like the Yu'vath, righteously exterminated during the Angevin Crusade in M39.

FRA'AL RAIDER – 50 Points

| TYPE / HITS | SPEED | TURNS | SHIELDS | ARMOR | TURRETS |
|-----------------|-------|-------|--------------------|-------|--------------------|
| Escort/1 | 25cm | 90° | 1 | 5+ | 2 |
| ARMAMENT | | RANGE | FIREPOWER/STRENGTH | | FIRE ARC |
| Weapons Battery | | 45cm | 2 | | Left/ Front/ Right |
| Lance Battery | | 30cm | 1 | | Front |

Notes: Fra'al utilize a complex targeting matrix that greatly improves the accuracy of their weapon batteries at long range; they treat all targets less than 30cm as closing and do not suffer a column shift for firing at targets greater than 30cm. The Fra'al will not ally themselves with fleets that include loyal Imperial Navy or Space Marine vessels.

While a small number of minor races encountered by the Emperor's subjects have like the Yu'vath shown unrelenting hostility and required righteous purgation, many more recognize the futility of such a course against the immeasurable might and majesty of the Imperium of Man and like the Demiurg and Nekulli have sought accommodation. The Tau however are another matter entirely. Never before has a single race managed to entice so many Imperial servants to set aside their concern for humanity for the raw profit that comes from dealing in alien artifacts, and examples of Tau technology actually made their way to Holy Terra itself before the Ordo Xenos and the Priesthood began to investigate the matter in earnest.

One Rogue Trader of considerable renown that succumbed to their promise of easy riches under their guise of "Greater Good" was Memet Poralius. A true privateer, Poralius was born the son of Urbit Poralius, planetary governor of the world of Moracre on the Eastern Fringe. Memet grew restless in the long years waiting to succeed his father, and so a wanderer was born. Poralius traveled far, and was soon introduced the emergent Tau empire. Poralius struck many illicit deals with the aliens and soon founded a trade route from Tau space all the way to his homeworld of Moracre. Thereafter, Poralius's wealth and fame grew immeasurably as he flooded the markets and bazaars of Moracre with all manner of illicit goods supplied by the distant Tau. Still not content, Poralius used his wealth to fund a rebellion against his own father, overthrowing the old man and assuming the throne with the blood still fresh on his hands. With his hold on power complete, Poralius turned to open allegiance with the Tau, and for a time great prosperity fell upon Moracre, as the youthful Tau eagerly exploited their newly forged alliance.

GHOUL STARS

GATES OF VARL

ULTIMA SEGMENTUM

DOMINION OF STORMS

Kar Duniash

The Ynga Monolith

Arda

MORDANT ZONE

Hive Fleet Behemoth

The Tyranid incursion of Hive Fleet Behemoth surges like a tide of death upon the southeast of the Eastern Fringe. The mighty Dominion of Ultramar was pressed against the polar fortress-monastery of Maccrage itself before a combined fleet of over 200 warships turned them back above the rings of Circe. So grave is the threat imposed by this ravaging horde that the righteous crusade of the Damocles Gulf was reconciled to an uneasy truce, enabling the Imperial Navy to regroup while the Tau face the brunt of this new assault.

How many other races like the Tau exist among the unexplored reaches of the Eastern Fringe? The Nekulli are a ragtag, refugee race, and their surviving ships are both quite ancient and demonstrate a high level of sophistication, suggesting they were once far more advanced than the level of technology they exhibit today. How many other Xenos races are already lost to Hive Fleet Behemoth before they were ever encountered by mankind? As Hive Fleet Behemoth continues encroaching upon the Eastern Fringe, the number of instances of the Imperium encounters previously unknown Xenos races fleeing their advance are only likely to increase.

San Leor

And henceforth be it known that the Imperium shall be divided into five fleet zones to be known as the Segmentae Majoris. These shall each have a Segment Fortress, from whence the orders of his glorious magnificence, the Emperor, shall be enacted. Imperialis Command Decoratum shall reside in each and with just duty be issued over the realms within their boundaries.

For the Segmentum Solar, this shall be Mars, World of the Adeptus Mechanicus and this Segment shall extend about Mars. Beneficent Emperor's Imperium. In the north of our most majestic domains shall be Segmentum Obscurus, being in fiefdom to the world of Cypra Mundi. To the South it shall make Segmentum Tempestus, with overlordship residing with the planetary estates of the hereditary Bakka.

To the West shall be Segmentum Pacificus, under the auspices of the Lords of Hydraplur. The most turbulent East, a region of much strife and dissension and of many lost worlds shall have its overlordship known as Ultima Segmentum, and its guarantor of safety shall be on the planetary Governor, Kar Duniash. The Segment Fortress of the Imperial official of the Administratum shall be known as the Master of the Segmentum Solar. Lastly, the region of Segmentum Pacificus, and the Master of the Ultima Segmentum. In this the Emperor is most benevolent and thus shall the Emperor's charges be authority over such domains and reside with those who have the faith and temperament to dictate to the will of those others and take from them that which is the Emperor's due.

TAU EMPIRE

Pavonis

But such ill-gotten gains could not last. Poralius' truck with aliens brought him to the attention of the Priesthood at a time when the Imperium was readying itself for war with the Tau, and Moracre would serve as a fine example to those who chose alien over brother-man at this dangerous time. Battlefleet Artemis was dispatched to the regions, and swiftly severed the trade links which had for so long been the source of Poralius' wealth. With orbital supremacy secured they deployed three dozen Imperial guard regiments to the planet's surface and Poralius' fate was sealed. Or so it would have appeared, but Poralius had escaped, and to this day an embittered and vengeful Memet Poralius labors faithfully in the service of the Tau empire, commander of the Tau's most notorious commerce protection fleet, the Akunavash (a crude title, taken from one of the less eloquent races of the empire, many of whom serve alongside Poralius' fellow human exiles in his fleet). Poralius remains a dangerous man. No compassion for his fellow man remains in Poralius – an alien is a good a friend of ally to him as men are hated foes and betrayers, and he has been known to travel as far afield as the Straits of Halk with Tau cruisers in attendance, pursuing his own bitter agenda. Where many of the Tau's privateers genuinely believe themselves to be nothing more than protectors of the Tau's trade rights, this is little more than an excuse to Poralius one that allows him to frequently venture to within the Imperium's borders and, at the slightest hint of danger, unleash a remorseless and vengeful attack against his former people.

THE TREACHERY OF DURANDAL GROHE

Memet Poralius was only one of many Rogue Traders and privateers that found an alliance with the Tau to be more appealing than maintaining their loyalty to the Imperium. While the freedom afforded Rogue Traders has led on some occasions to such

abuses that later needed to be rectified with varying degrees of prejudice, never has the actions of any single Rogue Trader betrayed the Imperium more gravely than the fall from grace of Durandal Grohe. Wealthy and renowned in star systems throughout the Ultima and Obscurus Segmentae, Durandal Grohe over a number of decades amassed a vast

The Straits of Halk

The Straits of Halk form the northwestern border of the region of Ultramar, dominion of the Ultramarines. The straits are nigh un-crossable and in no small way contribute to Ultramar's relative independence from other arms of the Imperium's authority, though of course the Ultramarines' own might remains the deepest root of their dominance. For millennia the straits offered little to would-be privateers, since all trade in the region fell under charter of the Regent of Ultramar and thus benefitted from protection from the Ultramarines themselves – an enemy too great for any pirate to contemplate an attack upon.

The coming of Hive Fleet Behemoth changed all this. The arrival of the Tyranids drew the Ultramarines' attention and the bulk of their forces southeastward. Though the initial invasion was repelled at great cost, the continuing grave threat posed by the Tyranids means that Ultramar must always keep a watchful eye to the east, and the resultant drain on overtaxed and finite resources effectively ended all patrols of the straits. The powerful warp shadow cast by the approaching hive fleet also made navigation difficult in many of the outlying areas of Ultramar, forcing new trade routes to be opened away from the blighted areas. Many of these new routes pass close to the Straits of Halk, providing an enticement too great to ignore for the dozens of privateer bands and nearby Xenos races that lurk there.

fortune that included continent-sized tracts of land and mineral rights on worlds in several different systems. First making his fortune while accompanying the lucrative Rogue Trader expedition to the Almonries sub-sector far in the Eastern Fringe in M709.M41, he over time gained possession of seven transports as well as the fast clipper *Durandal's Bliss* he utilized as his personal conveyance. After coming across a large trove of Xenos artefacts which he gladly turned over to the Adeptus Mechanicus for a tidy sum, he arose the suspicion of the Inquisition, but Techmagos Brunt Carnivir personally vouched for his integrity, and through subtle machinations a possible inquest was set aside. Grohe later brought several other artefacts from an undisclosed location to Techmagos Carnivir, but never revealed from where he received them except to say it was from a dead world located deep in the Obscurus Segmentum near the Tamahl Sector. When information came to him that there was fortune to be made across the uncharted Damocles Gulf, he was one of dozens of Rogue Traders that began to encounter the expanding race the Imperium now widely knew as the Tau, but few repeated the months-long perilous voyage as often as he did, first in his fast clipper accompanied by armed escort vessels he appropriated by special dispensation through his many contacts, and later on in a re-commissioned cruiser he acquired for this express purpose. His voyages across the Damocles Gulf did not abate when the Imperium waged war with this upstart race in the decade of 740.M41, and for a while he was regarded as a valuable source of information, with some of his reports reaching Cardinal Esau Gurney himself.

As word reached fleet headquarters at Kar Durniash in the years following the Damocles Gulf Crusade that the Tau were seen to be fielding new vessels with a rapidly-evolving level of technology that steadily approached levels of Imperium warships, fleetlords dispatched Inquisitor Ibrahim Matthias to investigate the probable cause. A cursory

investigation led Matthias to believe that Durandal Grohe was somehow responsible, and invoked a formal inquest to have the Rogue Trader explain his dealings with the upstart race. Grohe disappeared soon afterward, and for many years not a trace of any one of the nearly dozen vessels under his ownership were discovered save the considerably modified armed freighter *Corrigan* traveling with three merchant escorts built with obvious Xenos influence in the Birr system. These vessels refused to haul about when hailed to receive a boarding party, and they were ruthlessly hunted down and destroyed by the Lunar cruiser *Lord Krevoss* and its escorts as it attempted to flee.

More than five years later, Inquisitor Matthias received word from another Rogue Trader that a massive Tau fleet had crossed the Perdur Rift and was moving parallel to the Damocles Gulf traveling beyond what had become known as the Farsight Enclaves. When pressed, the Rogue Trader was unable to tell him the numbers or intended destination of this fleet, but that it was rumored that

it sought to make contact with other “displaced races” in the larger galaxy, and that it was being guided by a Rogue Trader who had a sizable number of extensively-modified Imperial-pattern vessels under his own command. Convinced that this could be none other than the now unquestionably traitorous Grohe, he sent word to the Kar Durniash fleetlords that a large flotilla must be dispatched with great haste to intercept and destroy this unknown host. However, it was about this time in 750.M41 that the massive swarms of Hive Fleet Behemoth were pressing hard upon the sectors of the Eastern Fringe near the home systems of the Ultramarines, and with much of the available fleet thus committed, only three cruisers, an Inquisition cruiser accompanied by two under-strength escort squadrons led by the Mars battlecruiser *Emendable* were able to give chase. Headed by Inquisitor Matthias, for nearly a year they doggedly pursued the “missing fleet,” but they could not find any trace of their whereabouts. They received a lucky break early the next year when arriving in the Koressa system to replenish stores, where they found the citizenry unusually hostile to

their presence and a large number of artefacts and technology that were unmistakably Tau in origin. An inquest of the planetary governor and her family quickly revealed that more than thirty Xenos capital ships had departed the system only five months before and that Grohe certainly was guiding them. Apparently the fleet had a large number of Merchant-class transports and Hero-class cruisers, as well as several alien vessels identified as possible Demiurg and Kroot warships, along with unusual escort-displacement vessels of a class never previously encountered. Inquisitor Matthias ordered the planetary governor and her family executed in the Square Korestii before the capital city’s population. As word spread of the executions, rioting ensued as planet-wide protests erupted against the inhumane brutality of their Imperial oppressors. With the Ultramarines occupied on the front against the Tyranids thousands of light years distant and no other Chapter available for proper cleansing, Inquisitor Matthias declared the population Excommunicate Tratoris and had the planet virus-bombed before the fleet moved out of orbit.

Having spent most of his life plying the space lanes between Segmentum Obscurus and Segmentum Ultima and having to avoid the predations of various alien races, it is easy for Durandal Grohe to hide from a fleet whose operating methods he knows so well. More time has passed with no sign of the missing fleet, though evidence seems to point to it taking a circuitous route toward some undisclosed point toward the Galactic North. Analysts are at a loss to explain for what purpose such a large Tau fleet would attempt to range so deep into Imperial space while managing to avoid contact with any elements of the Navy, but such can be nothing less than an exceedingly grave threat to the Imperium as a whole. For five more years Inquisitor Matthias relentlessly drove his haggard task force forward in pursuit of this “missing fleet” until contact with the *Emendable* was lost in the warp early in 756.M41.

ORDO XENOS DOSSIER: THE NEKULLI

Extremely little is known about the Nekulli, with reports about this race coming to the attention of the Ordo Xenos early in M41 through the glowing reports of a Rogue Trader who was later sanctioned and interrogated by the Inquisition. Based on available evidence, they are believed to be refugees from a group of systems far on the Eastern Fringe overrun by the Tyranids. A small number of Nekulli hulls, translated as “Whips,” were recovered from the Space Hulk *Allure* and examined by the Adeptus Mechanicus after 770.M41. While their vessels are outwardly unremarkable, the Nekulli utilize a little-understood but powerful energy source for their ships and weapon systems in general and their whisperlance technology in particular.

NEKULLI WHIP – 50 Points

| TYPE / HITS | SPEED | URNS | SHIELDS | ARMOR | TURRETS |
|---------------------|-------|--------------------|---------|--------------------|---------|
| Escort/1 | 25cm | 90° | 2 | 5+ | 2 |
| ARMAMENT | RANGE | FIREPOWER/STRENGTH | | FIRE ARC | |
| Weapons Battery | 45cm | 2 | | Left/ Front/ Right | |
| Whisperlance Cannon | 30cm | 1 | | Front | |

Notes: While highly efficient, whisperlance cannon behave as a lance battery in all respects.

ROGUE TRADER CRUISER 185 Points

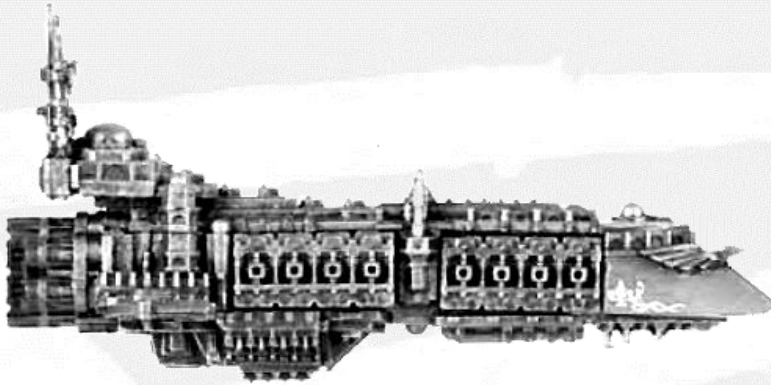

| TYPE /HITS | SPEED | TURNS | SHIELDS | ARMOR | TURRETS |
|---------------------------|-------|-------------|--------------------|--------------|----------|
| Cruiser/8 | 20cm | 45° | 2 | 5+ (prow 6+) | 3 |
| ARMAMENT | | RANGE | FIREPOWER/STRENGTH | | FIRE ARC |
| Port Weapons Battery | | 45cm | 6 | | Left |
| Starboard Weapons Battery | | 45cm | 6 | | Right |
| Port Weapons Battery | | 30cm | 4 | | Left |
| Starboard Weapons Battery | | 30cm | 4 | | Right |
| Prow Torpedoes | | Speed: 30cm | 4 | | Front |

Kar Durniash: Trader's Haven
 Being the Segmentum Fortress of the Ultima Segmentum, Kar Durniash is a favored departure point for countless voyages to the Eastern Fringe, the largest of the vast, unexplored tracts of wilderness space in the galaxy with its promise of adventure and undiscovered riches. Accordingly, it is also the return destination of many traders once their business in the Fringe is complete, and over the millennia has established itself as a welcome haven for exhausted traders and crews who may well have been beyond Imperial-controlled space for many years.

Rogue Trader cruisers take an infinite variety of forms, all based on standard Imperial cruiser patterns. The form these vessels take may vary greatly, based primarily on what particular forge world either constructed the vessel itself or leased its approved design template to the shipyard that constructed it. Thus, while Rogue Trader cruisers are generally recommissioned hulls of many different patterns, the most typical cruiser pattern utilized by Rogue Traders are those constructed at Kar Durniash and its surrounding systems. Conversely, for this same reason the pattern is also common to various Imperial Navy cruiser classes that operate throughout the Ultima Segmentum, such as the Lunar, Tyrant, Dominator, etc.

At least half the Rogue Trader cruisers in an Exploration fleet must be of the basic profile listed above, but Rogue Trader cruisers in an Exploration fleet may also be of the following Imperial or Chaos ship classes: Lunar, Tyrant, Carnage or Murder (even if used as a loyalist ship), for their normal point cost, +15 points if the ship is equipped with lances or 60cm weapons due to the additional expense maintaining such weapons, as reflected in the fleet list. Chaos vessels must be painted as such if used as loyalist ships, and no special variants in the notes of these ship's profiles can be used. For example, the Tyrant can't take boosted batteries or a Nova Cannon, etc.

Imperial cruisers are gigantic constructions, most of them centuries or even millennia old. Those few that are constructed anew are often the result of years of toil by the population of an entire world – enormous shipyards that might produce a single vessel every few decades. Even the mighty Forgeworlds with their unimaginably vast, serried ranks of orbital docks and laying yards may only complete one of these behemoths every year or so despite easily having a dozen or more of them in varying stages of construction at any one time. Such gargantuan efforts are beyond the ken of even Rogue Traders. Rather, most Rogue Traders rely on vessels built (and often owned) by others. Many cruisers are in fact part of the warrant of trade itself, an undeniably powerful aid gifted to the Rogue Trader by the Administratum as a bequest to their agent abroad. Other vessels are loaned to Rogue Traders more temporarily, perhaps being themselves Navy vessels given over to a Rogue Trader for a time where Imperial command thinks it beneficial. Rogue Trader vessels are unique, exotic things, often exhibiting many signs of their colorful adventures. Although typically based around the hulls of the more common Imperial cruiser classes, Rogue Trader vessels are subject to constant refit and adornment, much of it alien in origin, creating truly unique vessels. The business of a Rogue Trader can take him all over the galaxy and, while his vessel's class or hull pattern may be common in its sector of origin, it may virtually unknown in those which he travels, meaning a relatively standard cruiser may stand well apart in appearance from its Imperial Navy counterparts. Drawing such flamboyant attention to one's self is something most Rogue Traders hardly seek to avoid.



ENDEAVOR LIGHT CRUISER 110 Points

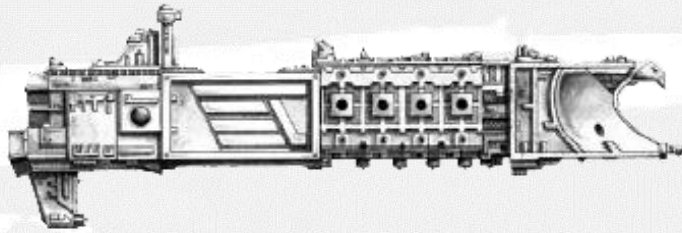

| TYPE /HITS | SPEED | TURNS | SHIELDS | ARMOR | TURRETS |
|---------------------------|-------|-------------|--------------------|-------|--------------------|
| Cruiser/6 | 20cm | 90° | 1 | 5+ | 2 |
| ARMAMENT | | RANGE | FIREPOWER/STRENGTH | | FIRE ARC |
| Port Weapons Battery | | 30cm | 6 | | Left |
| Starboard Weapons Battery | | 30cm | 6 | | Right |
| Prow Weapons Battery | | 30cm | 2 | | Left/ Front /Right |
| Prow Torpedoes | | Speed: 30cm | 2 | | Front |

Special Rules: Pirates and raiders are the bane of Rogue Traders, and they will be even more ready for such a threat than most. For this the cramped decks and confined spaces of Endeavor light cruisers are especially favored; these ships add +1 to their dice roll when defending against a boarding action. For no change in cost, Rogue Trader light cruisers can upgrade their prow armor to +6, but their rate of turn is reduced to 45 degrees if this option is taken.

Rogue Trader light cruisers may be used interchangeably in the same manner as Rogue Trader cruisers in any fleet or scenario that allows them. Instead of the Endeavor, Rogue Traders may use a lance-armed Dauntless light cruiser for +15 points due to the additional expense incurred maintaining such weapons, as reflected in the fleet list. The use of Dauntless light cruisers by Rogue Traders is not restricted to the Exploration Fleet List and may take them in the same manner as other Rogue Trader cruisers.



The Imperium is a vast domain, and throughout its history, the Imperial Navy has been stretched thin simply trying to maintain lines of communication as well as the countless patrols and show of presence required in a galaxy beset by treachery and conflict from within and without. To do this, the Imperium has relied on a countless number of light cruisers to conduct these lonely patrols. As capital ships, such vessels tend to be lighter and more agile than their larger cousins, and they are easier and cheaper to construct as well. As a consequence, while there are only several dozen different approved patterns throughout the Imperium from which all the various cruiser and battlecruiser classes utilized by the Imperial Navy are derived, there are literally hundreds of different Imperial light cruiser patterns constructed throughout the galaxy.

While many Rogue Traders aspire to acquire the vast behemoth that a cruiser-displacement vessel represents, others find that a light cruiser is more suited to the kinds of missions they undertake and the operating expenses they can absorb. The Endeavor is one of the oldest and most common of the many light cruiser classes operating throughout Imperial space. As such, there is a great surplus of decommissioned Endeavor light cruisers in a large variety of patterns available throughout the Imperium, and it is not unusual for many of these to find their way into the hands of Rogue Traders or the merchant families that fund their exploits. It is also commonplace for the Imperial Navy or even the Adeptus Mechanicus to lend one or a small number of these vessels to a Rogue Trader expedition. The Adeptus Mechanicus in particular operates a large number of these vessels, modified in various ways with all manner of advanced technology they have at their disposal, and they are quick to detail them on such Rogue Trader exploratory missions in their never-ending quest for technological perfection.

HEAVY TRANSPORT 40 Points

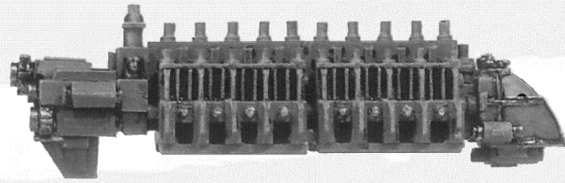

| TYPE /HITS | SPEED | TURNS | SHIELDS | ARMOR | TURRETS |
|---------------------------|-------|-------|--------------------|--------------------|---------|
| Cruiser/6 | 15cm | 45° | 2 | 5+ | 2 |
| ARMAMENT | | RANGE | FIREPOWER/STRENGTH | FIRE ARC | |
| Port Weapons Battery | | 15cm | 3 | Left | |
| Starboard Weapons Battery | | 15cm | 3 | Right | |
| Prow Weapons Battery | | 15cm | 2 | Left/ Front /Right | |

Special Rules: Despite their size and complexity, heavy transports have little in common with true warships. Like other normal cargo ships, they only move +3D6 when under *All Ahead Full* special orders. They are worth four assault points (two if crippled) in planetary assault scenarios when within 30cm of the planet edge and have the value of two regular transports (one if crippled) in scenarios that require transports. When included in a Rogue Trader fleet in a campaign or one-off game, they may take one refit from the Xenotech systems table for +10 points.

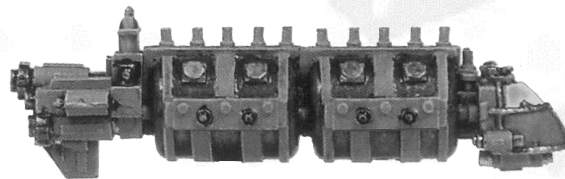

Fuel Tanker: For no extra cost or change in profile a heavy transport can be a fuel tanker. In addition to the special rules above, fuel tankers suffer critical damage on a roll of 5+ instead of a 6 normally. If fuel tanker is reduced to zero hits, it rolls 3D6 on the catastrophic damage table instead of 2D6, adding the result of all three dice together. These vessels are especially critical to a Rogue Trader and the operations of a given fleet in general; every one that survives at the end of the game without disengaging earns +1 renown to the owning player, even if crippled.

Representing Heavy Transports

Across the millions of worlds of the Imperium of Man, there are far more merchant vessels and heavy transports than there ever will be warships of the Imperial Navy. Heavy transports in particular are of almost every size and shape, and they are typically constructed so that form follows function. For example, transports designed to carry bulk ores or foodstuffs will appear noticeably different from those designed to carry compartmentalized, containerized cargo, ammunition or spare attack craft for fleets operating near war zones. Even tankers need not necessarily wield dangerous or flammable cargoes; on desert worlds, water is as precious and valuable a commodity as any rare gems.

Across the Imperium there are a vast array of different space faring vessels, any of which can be pressed into service of the Imperial Navy at need. Typically, heavy transports are used as bulk ore, fuel or grain carriers, and damaged vessels have been converted into supply bases, hospital vessels and forward repair facilities for fleets operating in isolated or primitive systems.

Every Imperial fleet is supported by hundreds of chartered or commandeered merchant vessels used to transport supplies between embattled systems. While heavy transports not normally used in this role, each heavy transport is capable of carrying tens of thousands of men and thousands of vehicles. They are also used by Adeptus Mechanicus Titan Legions for moving their huge war machines or enough munitions to supply an entire army. Most fleet commanders assign dedicated escort vessels to a squadron of heavy transports, as the loss of one of these vessels during a planetary assault can have huge long-term effects on a campaign.

Many other specialized heavy transports provide unique abilities to a given fleet. Unfortunately, they are particularly sought out by enemies and are always present in scenarios requiring transports.

Repair Tender (+50 points): Augmented by personnel and servitors of the Adeptus Mechanicus, these ships are vital for quickly repairing and refitting warships close to the battlezone. Purchasing a repair tender adds +1 renown or two repair points to the owning player at the end of every battle (even if crippled), but the enemy gains +1 renown for crippling or +2 renown for destroying it.

Super-Heavy Transport (+50 points): Some heavy transports are extraordinarily vast behemoths of the stars, serving the core worlds of the Imperium as supertankers or as bulk ore carriers bound for the foundries of Mechanicus worlds. Such vessels add +4HP to their profile and count as three normal transports (two if crippled). However, they turn like battleships and are mounted on a large base. Their profile and special rules are otherwise unchanged.

XENOS VESSEL 50 Points



| TYPE /HITS | SPEED | TURNS | SHIELDS | ARMOR | TURRETS |
|------------------|-------|-------|--------------------|-------|--------------------|
| Escort/1 | 25cm | 90° | 1 | 5+ | 2 |
| ARMAMENT | | RANGE | FIREPOWER/STRENGTH | | FIRE ARC |
| Weapons Battery* | | 45cm | 2 | | Left/ Front/ Right |
| Lance Battery* | | 30cm | 1 | | Front |

Special Rules: The profile above represents a whole variety of alien vessels that may be found in a Rogue Trader's personal escort. Since Rogue Traders tend to choose vessels for certain specific purpose, many of the Xenos vessels employed as mercenaries will be similar, though never entirely identical. For this reason, a single ship profile is used, but to better represent the great variety of Xenos vessels that may be encountered in the 41st millennium, each Xenos vessel also has one selected xenotech system as described in the Rogue Trader special rules.

Unlike other Rogue Trader vessels, this system does not cost extra points may be selected by the owning player for free, whether they are used in a Rogue Trader fleet, as pirate raiders or even their own, independent squadron of Xenos warships. However, all Xenos Vessels of the same type or race must all use the same refit, though multiple types or races may be in the same fleet, each easily identified by distinctly different models.

Representing Xenos Vessels

There is any number of spacefaring minor alien races spread across the galaxy. Some of these are virtually unknown to the Imperium, while others are frequent raiders whose names have come to be cursed by spacers the galaxy over. This incredible variation means that you can represent Xenos vessels in pretty much any way you want. The Pthuxutt, Fra'al and Nekulli provided in the text are only three of any number of examples that can be used; the galaxy of the 41st millennium is filled with many other minor alien races such as the Psy-Gore, Q'Orl, and Tallerians. Xenos vessels provide an ideal opportunity to convert or scratch-build vessels to your own taste. With each new vessel or group of vessels you build, you should make a name for the alien race, and perhaps a little bit of your own background. You might even like to choose to accurately represent on your models which xenotech system the ship possesses and write some background explaining why the race in question possesses the particular advancements that they do.

**Xenos vessel weapon systems, like the vessels themselves, represent a wide variety of technologies. While the weapon systems may take any form and be described in any manner desired, their behavior will be as the weapons indicated in the Xenos Vessel profile. It can only be modified by one of the Xenotech systems described on p.80.*

Contact with alien races is without doubt the habit for which Rogue Traders gain the most notoriety. Their exploration and trading missions necessarily take them to regions of space beyond Imperial control, sometimes for years at a time. In these regions there is every chance of finding thriving, spacefaring alien cultures, even alien empires spanning several systems. Rogue Traders can gain much of value and interest from these races, and are certainly not above employing them as mercenaries when the situation demands.

Far from home, where the protection of the Imperial Navy is but a hopeless dream, many Rogue Traders instead for protection hire out vessels and their crews from among the alien races they encounter. These vessels often provide much-needed local knowledge, as well as the ability to overcome cultural or linguistic barriers along with a healthy dose of firepower when required. Particularly bold Rogue Traders will, from time to time, journey back into Imperial space with their alien operatives still in tow, perhaps keen to make continued use of the exotic weaponry that their vessels provide. Rogue Traders typically favor hiring races that have vessels that make use of advanced energy technology, since the huge power supplies and impossibly difficult upkeep needed for the Imperium's own lance weaponry generally makes them unsuitable by Rogue Traders, isolated as they often are for years at a time, far from Imperial docks or repair facilities.

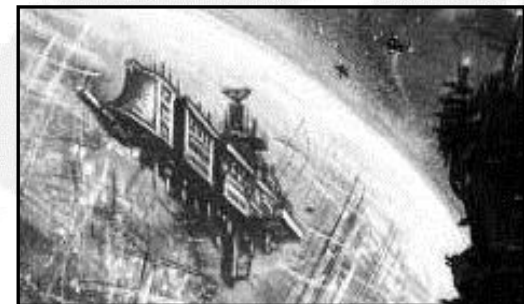

ROGUE TRADER CARGO VESSEL 20 Points

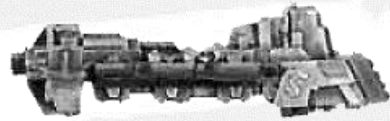

| TYPE /HITS | SPEED | TURNS | SHIELDS | ARMOR | TURRETS |
|-----------------|-------|--------------------|---------|--------------------|---------|
| Escort/1 | 25cm | 45° | 1 | 5+ | 1 |
| ARMAMENT | RANGE | FIREPOWER/STRENGTH | | FIRE ARC | |
| Weapons Battery | 30cm | 1 | | Left/ Front/ Right | |

Special Rules: Rogue Trader cargo vessels have more in common with true warships than typical freighters, giving up a significant portion of their cargo capacity to mount warship-grade weapons and engineering plants. They move +4D6 when under *All Ahead Full* special orders as warships do. They are worth one assault point in planetary assault scenarios when within 30cm of the planet edge and count as a half-transport (rounding DOWN) in scenarios that require transports. This means that if it is the only one remaining in a convoy scenario, it counts as zero.

When included in a Rogue Trader escort squadron and *not* being used as a transport in scenarios that require them, it offers +1Ld to Reload Ordnance by ensuring escorts have a ready supply of torpedoes before the battle. This effect is not cumulative if there is more than one Rogue Trader cargo vessel in the escort squadron.

Fast Clipper: Instead of taking a refit normally, for no extra cost this vessel type can be converted to a fast clipper by entirely removing its primary battery armament for the Advanced Drive Technology refit on p.80.

Representing Armed Cargo Vessels

Rogue Trader armed cargo vessels represent a variety of specialized merchant transports with upgraded engines, modified armament and other technological advances incorporated by Rogue Traders as required. Feel free to use any freighter or clipper type ship model with a few additional guns glued on to represent armed cargo ships.

Rogue Traders necessarily make use of a wide range of freighters and other cargo ships to transport their wares back to Imperial space as well as to serve as personal conveyances as needs arise. The danger Rogue Traders face on their journeys into wilderness space and beyond the Imperium's borders is significant enough that they will commonly upgun their cargo ships where capacity permits. Such alterations are rarely permanent, and Rogue Traders will often abandon some of their escort's weaponry or additional power generating systems to make space for more lucrative cargoes as and when they chance upon it or the need arises. However, where a Rogue Trader's business calls for him to actively engage in combat, armed cargo ships are likely to be a common feature of his personal escort.

An incredible variety of different vessels are used as armed cargo ships, but such is the limited space, power supply and support systems of these vessels that no matter what their original design, most are likely to bear the same simple arrangement of weaponry, turrets and shields. In fact, the crew of an armed cargo ship is likely to be the same merchant spacers responsible for its operation even when unarmed or when its mission-specific equipment is removed. As such, the weapons with which the vessel can be equipped are limited to those which the crew can be hastily trained to use.



RECOMMISSIONED ESCORT 30 Points



Being the opportunistic individuals they invariably are, it is not uncommon for Rogue Traders to 'acquire' decommissioned Navy vessels or those relegated to a Segmentum's reserve fleet. Despite typically being in poor condition, it is well within most Rogue Trader's means to refit and restore such a vessel, sometimes using systems and technology quite unlike its original components.

Due to the weapons mounted by such vessels such as torpedo tubes, an experienced crew is needed to man true warships such as this. Rogue Traders will typically recruit mercenaries, retired Naval ratings and able spacers or even deserters and mutineers.

| TYPE /HITS | SPEED | TURNS | SHIELDS | ARMOR | TURRETS |
|-----------------|-------|-------|--------------------|-------|--------------------|
| Escort/1 | 30cm | 90° | 1 | 5+ | 1 |
| ARMANENT | | RANGE | FIREPOWER/STRENGTH | | FIRE ARC |
| Weapons Battery | | 30cm | 2 | | Left/ Front/ Right |
| Prow Torpedo | | 30cm | 1 | | Front |

ICONOCLAST DESTROYER 30 Points

| TYPE /HITS | SPEED | TURNS | SHIELDS | ARMOR | TURRETS |
|-----------------|-------|-------|--------------------|-------|--------------------|
| Escort/1 | 30cm | 90° | 1 | 4+ | 1 |
| ARMANENT | | RANGE | FIREPOWER/STRENGTH | | FIRE ARC |
| Weapons Battery | | 30cm | 3 | | Left/ Front/ Right |

This class is a ubiquitous, easily reproducible design encountered in many patterns and long since superseded by more advanced escort types by the Imperial Navy. The same characteristics that make it favorable to Chaos and pirate fleets make it a mainstay for even the most loyal Rogue Traders in that it is simple to maintain and can be crewed by personnel with only minimal training.

Using Iconoclasts in a loyalist fleet: Iconoclast destroyers can be used in a loyalist Rogue Trader fleet like any other escort in a Rogue Trader squadron, but it must be suitably painted as such. You cannot simply take Iconoclasts painted for a Chaos fleet and call them loyalist!

AUXILIARY VESSELS VARIES

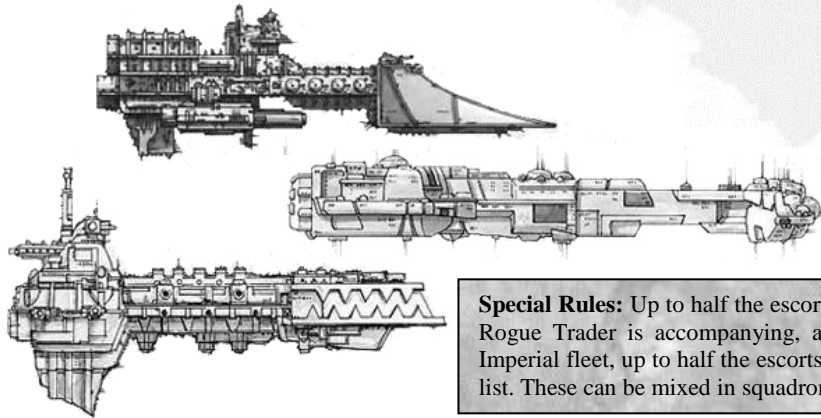

Rogue Traders will commonly petition for the use of a fleet's vessels as part payment for their services, and on occasion may even retain the vessels permanently. Most fleet commanders are more than happy to have a small number of their own ships acting in concert with any Rogue Traders in their employ, not least because they are likely to trust their own escort officers and crews rather more than they trust Rogue Traders.

Special Rules: Up to half the escorts in a Rogue Trader fleet may be vessels picked from the fleet list the Rogue Trader is accompanying, at the normal cost. For example, if accompanying a Gothic Sector Imperial fleet, up to half the escorts in the fleet can be picked from the Gothic Sector Imperial Navy fleet list. These can be mixed in squadrons (up to 6 ships) with Rogue Trader escorts in any manner desired.

ROGUE TRADERS IN BATTLEFLEET GOTHIC

COMMANDER

0-2 Veteran Rogue Traders

A Veteran Rogue Trader may lead each Rogue Trader cruiser in a fleet. If a fleet has more than one Rogue Trader cruiser or also includes more than one squadron of transports, a Veteran Rogue Trader must be assigned to a Rogue Trader cruiser.

Veteran Rogue Trader (Ld9) 50 points

A Veteran Rogue Trader gets one re-roll, which may be used for his vessel or an accompanying Rogue Trader escort squadron.

CAPITAL SHIPS

Any fleet except Necrons or Tyranids may include a single Rogue Trader capital ship. Tau, Demiurg and Imperial fleets may include one Rogue Trader cruiser for every 750 points or part thereof in their fleet. If a second Rogue Trader cruiser is taken, it may be any Rogue Trader cruiser variant listed on the Exploration Fleet List. Rogue Trader cruisers always count against cruiser restrictions in any fleet list that has such restrictions. Heavy transports may not be in squadrons with other transport types.

Rogue Trader Cruiser 185 points

Dauntless Light Cruiser 125 points

Endeavor Light Cruiser 110 points

Heavy Transport 40 points

ESCORTS

A single squadron of 2-6 Rogue Trader escorts and auxiliary vessels may accompany each Rogue Trader capital ship in a fleet, in any mix desired. Separately, it may also be accompanied by any number of cargo ships of any type (whether or not the scenario requires transports), organized in squadrons of 2-6 ships, but these squadrons can only contain cargo ships and always count against their full cost against the total points in the fleet. Xenos vessels cannot be used in fleets that include Space Marine ships.

Xenos Vessel 50 points

Recommissioned Escort. 30 points

Iconoclast Destroyer 30 points

Rogue Trader Cargo Vessel 20 points

Auxiliary vessels Varies

USING ROGUE TRADER VESSELS

Xenos Allies

Experienced Rogue Traders will develop special relationships with other spacefaring races that have similar trade interests. For every 750 points in the fleet, Rogue Traders may be accompanied by a single Demiurg or Kroot vessel unless the fleet is using auxiliary ships that cannot be allies with the Demiurg or Kroot (such as Space Marines).

Sub-plots

Rogue Traders by nature are far from altruistic. Their presence in a fleet indicates they have something to gain by forming a temporary alliance. Whether their own goals actually benefit their erstwhile comrades is usually debatable. Any game that includes a Rogue Trader cruiser must include a sub-plot from p.82-84 in the Rulebook. This can be imagined as representing the Rogue Trader's own vested interest. As such, if the owning player fails the sub-plot, the enemy earns victory points as if the Rogue Trader cruiser was crippled (in addition to any renown gained or lost normally). If the Rogue Trader was actually crippled in addition to failing the sub-plot, it counts as if being destroyed. The enemy gains no additional bonus for actually destroying the Rogue Trader cruiser except that for renown purposes that the owning player automatically fails the sub-plot. However, if the Rogue Trader cruiser survives the game (even if crippled) and the owning player succeeds in the sub-plot, the owning player gains +1 renown in addition to any gained normally.

If the Rogue Trader disengages and you complete the sub-plot, the enemy gains no victory points for the Rogue Trader cruiser, regardless of its condition. However, if it disengages and the owning player fails the sub-plot, it counts as being destroyed for

purposes of victory points, though it may remain on the owning player's fleet list if used in a campaign.

The Best Money Can Buy

Rogue Trader capital ships and escorts commonly bear refits of uncertain origin. Even the vessel's crew are unlikely to be anything as straightforward as regular spacers, since Rogue Traders have a knack for acquiring crowds of followers and hangers-on, and tend to be rather indiscriminate in who they take on to crew their vessels. Their command crews however tend to be deeply seasoned after many years in space, and successful Rogue Traders tend to be as experienced as the most veteran Naval captains. To represent this each Rogue Trader cruiser and escort squadron may roll one random crew skill on p.157 in the Rulebook for +10% point value. In addition, each Rogue Trader vessel may roll randomly against the Xenotech System table below for +15 points per cruiser or +5 points per escort. For an *additional* +5 points per ship, the player can select the desired technology instead of rolling randomly for it. Auxiliary vessels in a Rogue Trader escort squadron can only use these refits if they are in a squadron that includes at least three Rogue Trader escorts.

XENOTECH SYSTEMS

1. **Long Range Sensors:** The vessel adds +1 to its base leadership (max of Ld10).
2. **Targeting Matrix:** The vessel counts all targets as closing when using the gunnery table within 30cm and ignores right-shift modifiers for shooting greater than 30cm.
3. **Advanced Shielding:** The vessel increases the strength of its shields by +1.
4. **Ship Defense Grid:** The vessel increases the strength of its turrets by +1.
5. **Advanced Drive Technology:** The vessel adds +5cm to its speed as well as +1D6 when undergoing *All Ahead Full* special orders.
6. **Gravitic Thrusters:** The vessel can double the maximum rate of its normal turn.

THE ROGUE TRADER EXPLORATION FLEET LIST

FLEET COMMANDER

Veteran Rogue Traders

A Veteran Rogue Trader may be present for every two Rogue Trader cruisers in a fleet. At least one Veteran Rogue Trader must be assigned to a Rogue Trader cruiser in the fleet.

Veteran Rogue Trader (Ld9) 50 points
A Veteran Rogue Trader gets one re-roll, which may be used for his vessel or an accompanying Rogue Trader escort squadron.

CAPITAL SHIPS

Your fleet may include no more than twelve capital ships, at least half of which must be Rogue Trader Cruisers and/or Endeavor light cruisers, following the basic profile for this ship.

Lunar Cruiser 195 points
Carnage Cruiser 195 points
Rogue Trader Cruiser 185 points
Tyrant Cruiser 185 points
Murder Cruiser 185 points
Dauntless Light Cruiser 125 points
Endeavor Light Cruiser 110 points

ESCORTS

A single squadron of 2-6 Rogue Trader escorts, Rogue Trader cargo ships and auxiliary vessels may accompany each Rogue Trader cruiser in a fleet, in any mix desired. Besides Xenos vessels, auxiliary vessels from only one race can be taken in a fleet. Any race can be used to provide auxiliary vessels except Orks, Dark Eldar, Necrons and Tyranids. Xenos vessels cannot be employed if Space Marine escorts are used as auxiliary vessels.

Xenos Vessel 50 points
Recommissioned Escort 30 points
Iconoclast Destroyer 30 points
Rogue Trader Cargo Vessel 20 points
Auxiliary vessels Varies

TRANSPORTS

The fleet must include at least one squadron of escort-sized cargo ships of any type (whether or not the scenario requires transports), in a squadron of

2 to 6 ships. Any number of cargo ships beyond this number may be taken, organized in squadrons that only contain cargo ships. These count their full cost against the total points in the fleet, and regular transports are not free. Heavy transports may also be taken but not in squadrons with other transport types. No more than 1/3 of the fleet's total transport value can be made up of heavy transports.

Escort Carrier 60 points
Q-ship 60 points
Heavy Transport 40 points
Rogue Trader Cargo Vessel 20 points
Armed Freighter 20 points
Cargo Transport 10 points
Transports taken for the fleet can be used for any scenario that actually requires transports.

RESERVES AND ALLIES

Up to one cruiser from any fleet except Orks, Necrons and Tyranids can be taken for every three Rogue Trader cruisers in the fleet. Capital ships taken count against the cruiser limit, they can only be from one fleet and cannot be from a fleet list differing from that used to provide escort squadron auxiliary vessels. If the fleet is large enough that three reserve or allied capital ships are taken, a single (0-1) allied battleship may also accompany the fleet for its regular point cost without counting against cruiser limits. Reserves and Allied vessels do not have access to the Veteran Rogue Trader re-rolls, but allied vessels may purchase up to one special character from its own fleet list (if available).

THE DEMIURG

At least one Demiurg vessel of any class may be taken for every three Rogue Trader cruisers in the fleet. This is separate from and in addition to any reserve or allied cruisers taken, but each Demiurg vessel taken still counts against the twelve-cruiser limit, and no more than one Stronghold may be taken. Demiurg vessels may not be employed if Space Marines are taken as reserves, allies or escort squadron auxiliary vessels.

Stronghold Commerce Vessel 350 points
Bastion Commerce Vessel 255 points
Citadel Commerce Vessel 185 points

THE KROOT

A single Kroot Warsphere may be taken if there are at least three Rogue Trader cruisers in the fleet. This is separate from and in addition to any reserve or allied cruisers taken, and the Kroot Warsphere does not count against the twelve-cruiser limit. A Kroot Warsphere may not be employed if Space Marines are taken as reserves, allies or escort squadron auxiliary vessels.

Kroot Warsphere 145 points

USING A ROGUE TRADER FLEET

Attack Rating

When used with this fleet list, Rogue Traders have an attack (initiative) rating of 3.

Xenos Allies

The rules listed on this fleet list take the place of those listed on p.80 concerning incorporating Kroot or Demiurg vessels into a fleet accompanied by a Rogue Trader cruiser.

Sub-plots

A Rogue Trader fleet more often than not operates in wilderness space far from support or assistance should the need arise. Any game using the Rogue Trader fleet list must include a sub-plot from p.82-84 of the Rulebook.

The Best Money Can Buy

The Xenotech Systems refit list can only be used by Rogue Trader cruisers and escorts, not by other reserves or allied vessels in the fleet. Over the course of a campaign, Rogue Trader cruisers cannot earn additional refits from the Xenotech list and must use the refit tables listed on p.156 of the Rulebook. Rogue Traders that join the fleet over the course of a campaign may start by taking one refit from the Xenotech list for the appropriate point cost for rolling randomly or selecting it.

PIRATES AND WOLF PACKS IN BATTLEFLEET GOTHIC

LEADERSHIP

A human pirate requires great charisma and leadership ability just trying to keep his or her grip on the bands of criminals, mutineers and other such unsavory characters that make up a pirate fleet. All pirate vessels suffer a -1 leadership modifier, meaning their unmodified starting leadership will be from 5 to 8.

FLEET COMMANDER

0-3 Pirate Captains

A Pirate Captain may be embarked on a cruiser for every 500 points or portion thereof in a fleet. If a pirate fleet has more than 750 points of ships, a Pirate Captain must lead it.

Pirate Captain (+1Ld) 50 points
A Pirate Captain gets one re-roll, and may purchase up to two more re-rolls for +25 points each. He (or she!) must be placed aboard the most expensive vessel in the fleet (or vessels if more than one Captain is present). Pirate Captains may use their re-rolls on any vessel or escort squadron in the fleet, but no individual Pirate Captain may use more than one re-roll per turn.

CAPITAL SHIPS

Pirate fleets do not ally with any race, as they are only in business for themselves and consider any ship they encounter and can easily defeat a target of value and opportunity. A human pirate fleet may have up to one cruiser for every 500 points of ships in the fleet or portion thereof.

A Pirate Cruiser may consist of a Rogue Trader cruiser or any cruiser from the Imperial or Chaos fleet list 185 points or less. It may also include a single Space Marine strike cruiser! Special variants, refits and Nova Cannon cannot be used. Otherwise there are no restrictions on how many Chaos and/or Imperial cruisers are in a single pirate fleet.

ESCORTS

At least one squadron of three to six escort vessels must be included for each cruiser in the fleet,

organized in any mix desired. While transports of various types are typically not included in a raiding fleet once they have been plundered, they can be used if desired but are never free. Note: Pirate bands do not have ready access to complex weapon systems. The number of escort vessels that utilize ordnance or lance weaponry may not outnumber those that rely solely on weapon batteries. Xenos vessels of all types don't count toward this total.

| | |
|-------------------------------------|-----------|
| Escort Carrier | 60 points |
| Q-ship | 60 points |
| Xenos Vessel | 50 points |
| Idolator Raider | 45 points |
| Infidel Raider | 40 points |
| Firestorm Frigate | 40 points |
| Sword Frigate | 35 points |
| Falchion Frigate | 35 points |
| Cobra Destroyer | 30 points |
| Recommissioned Escort | 30 points |
| Iconoclast Destroyer | 30 points |
| Rogue Trader Cargo Vessel | 20 points |
| Armed Freighter | 20 points |
| Cargo Transport | 10 points |

XENOS FREEBOTERS, CORSAIRS AND BRIGANDS

The desire to pillage the riches of others for reasons both obvious and more obscure is not a uniquely human trait. The general confusion and disarray caused by a successful pirate campaign against a given system or group of systems attracts the baser elements of all races, all eager for quick riches, slaves or the more subtle rewards that come from a life of plunder. Up to 10% of a pirate fleet may be made up of alien escorts from any race except Tyranids, Necrons or vessels that require support from a capital ship of their race, such as Nicassar Dhows or Tau Orcas. They can be organized in squadrons of two to six ships, but vessels of different races may not combine with each other into a single squadron, nor can they combine into squadrons with human (Imperial, Chaos or Rogue Trader) vessels. In

other words, a squadron of three Eldar escorts and a squadron of three Ork escorts may both be part of the same pirate fleet, but they can only squadron with themselves and NOT with each other or with any Idolators, Swords, etc. The only exception to this is Rogue Trader Xenos Vessels, which represent minor alien races seeking to expand their influence or pursue some other obscure agenda. They may freely ally themselves with any other race and join with them in pirate raider squadrons.

Xenos freebooters and corsairs have no allegiance to the human pirates they serve alongside. They may not use any of a Pirate Captain's re-rolls, and will automatically attempt to disengage if the escort squadron is crippled (reduced to half their starting number). They are not restricted to nor benefit from the leadership values of human pirates and must use the unmodified leadership from the fleet lists of their respective races.

USING PIRATE VESSELS

Pirate fleets make it their business to attack relatively soft targets such as transport convoys, remote space stations or isolated settlements. They will whenever possible avoid fleet actions or any engagement that will result in substantial losses with little material gain. However, large pirate bands with a substantial fleet at their disposal may elect to actually raid larger planetary colonies.

Pirate fleets have an attack rating of 3. When selecting scenarios, Pirates always roll against the Raid table on p.65 of the Rulebook. However, if the Pirate fleet is the attacker and has a fleet 1,500 points or greater, they may elect to play a Planetary Assault on a D6 roll of 6. For campaigns, pirate fleets operate from a pirate base as described on p.151 of the Rulebook. They have very limited access to formal shipyards and cannot earn refits in the course of a campaign, but they may instead earn crew skills in the manner other fleets earn refits, in addition to earning them normally.

NEW SCENARIOS FOR ROGUE TRADER FLEETS

In the depths of space, Rogue Traders never know what kinds of threats they will encounter. Additionally, while they may be contracted by an Imperial Commander to escort a given convoy in good faith, as often as not such vessels and their intrepid captains end up being used as fodder to flush out the nature and scope of a given threat in a contested system before the Imperial Navy allocates suitable forces for the task. While this pragmatically husbands the overstretched resources of the Imperial Navy, it brings no profit to the hapless Rogue Trader! The threat tables below are intended for use as alternatives with the Convoy Run scenario in the Battlefleet Gothic Rulebook. If used, the defending player may add up to +50 points worth of ships to whatever point value is allowed in the scenario to defend the convoy for every two normal transports (or their equivalent) taken.

1. THE CRUISER TRAP

This table represents a stronger force of attacking capital ships being in the area the convoy is traversing. This table may be used in lieu of any table used to determine the attacking fleet in a convoy run scenario.

| D6 | ROLL RESULT |
|----|--|
| 1 | Two attack craft or deadfall torpedo counters. |
| 2 | Three attack craft or deadfall torpedo counters. |
| 3 | A squadron of escort ships worth up to 150 points. |
| 4 | One capital ship worth up to 185 points. |
| 5 | One capital ship worth up to 210 points. |
| 6 | One capital ship worth up to 250 points. |

2. STALKERS OF THE ABYSS

History is replete with stories of varying authenticity of daemon ships, void-swimming leviathans and other such malevolent denizens of the warp. Much of it is likely a consequence of the Tyranids' continuing expansion into the galaxy, as evidence indicates their cruisers will continue to subsist when disconnected from the hive mind. However, a number of sobering reports describe events and circumstances that defy explanation. Some regions of space over the centuries have gained a reputation of being haunted by warp beasts and other mysterious threats, particularly the Bhein-Morr subsector, other regions near the Eye of Terror or Maelstrom, and entire sectors of space near the Northern Rim. Warp beasts always attack the closest defending ship in range,

cannot undergo any special orders (including Brace For Impact), and automatically pass all tests they must make against celestial phenomena. Each warp beast (3 to 5) rolled on the below table is worth a flat 100 victory points.

When activated, daemon mine counters are replaced by D3+2 daemon mines, which function as orbital mines in all respects except that they move an extra D6cm each time they move, and they have a 4+ save when attacked by fighters. Each is worth 10 victory points when destroyed for any reason.

| D6 | ROLL RESULT |
|----|--|
| 1 | One daemon mine counter. |
| 2 | Two daemon mine counters. |
| 3 | Warp Beast! A squadron of 2D6 Tyranid drone escorts equipped with feeder tentacles. |
| 4 | Warp Beast! A Tyranid cruiser equipped <u>only</u> with prow massive claws and thorax feeder tentacles. |
| 5 | Warp Beast! A denizen of the warp that is Defense/4, Armor 6+, 2 turrets, 2 shields. It has no weapons and moves 10cm in any direction per turn, no more or less. When it comes in base contact with <u>any</u> ship, it and the ship <u>immediately</u> disappear! Ships taken count as destroyed. It reappears in D3 turns in the same manner as Chaos daemonships, centering the template where it disappeared. |
| 6 | One Chaos daemonship worth up to 250 points total, including any Chaos Marks. |

3. THE OLD MINEFIELD

This table represents a convoy being routed through

a gap between old minefields, an obvious place for a clever enemy to lay a trap for passing merchantmen. Orbital mine counters are replaced by D3+2 orbital mines when activated.

| D6 | ROLL RESULT |
|----|--|
| 1 | One orbital mine counter. |
| 2 | Two orbital mine counters. |
| 3 | One orbital mine counter and one attack craft or deadfall torpedo counter. |
| 4 | A squadron of escort ships worth up to 150 points. |
| 5 | A squadron of escort ships worth up to 180 points. |
| 6 | One capital ship worth up to 210 points. |

4. THE WOLF PACKS

This table represents an attacking fleet that relies heavily on raiders and other escort warships. This is more representative of the renegade "wolf packs" which preyed on all sides in the Gothic War.

| D6 | ROLL RESULT |
|----|---|
| 1 | One attack craft or deadfall torpedo counter. |
| 2 | Two attack craft or deadfall torpedo counters. |
| 3 | A squadron of escort ships and/or Xenos vessels worth up to 100 points. |
| 4 | A squadron of escort ships and/or Xenos vessels worth up to 150 points. |
| 5 | A squadron of escort ships and/or Xenos vessels worth up to 200 points. |
| 6 | One capital ship worth up to 250 points. |

Note: While these alternate tables and the scenarios on the following pages are well suited to Rogue Traders and pirates, there is absolutely no reason why they can't be used in one-off games or within a campaign between any two fleets.



SCENARIO ONE: MERCHANTMEN'S FOLLY

Far from controlled space, a Rogue Trader accompanies a large formation of heady explorers and hastily-contracted merchantmen to a newly-colonized world. Such a ragtag fleet is difficult to keep disciplined and is ripe for the picking by unscrupulous pirates and bandits of every stripe, but they may not be as helpless as they seem...

FORCES

Attacking Forces. Attacking forces are randomly generated and set up first. To determine the total strength of the attacking forces, make D3+5 rolls against the table below from the attacker's fleet list. Alternatively, the attacker may use one of the alternate threat tables on p.83.

| D6 | ROLL RESULT |
|----|--|
| 1 | One attack craft or deadfall torpedo counter. |
| 2 | Two attack craft or deadfall torpedo counters. |
| 3 | Three attack craft or deadfall torpedo counters. |
| 4 | A squadron of escort ships worth up to 100 points. |
| 5 | A squadron of escort ships worth up to 150 points. |
| 6 | One capital ship worth up to 200 points. |

Defending Forces. The convoy must include the value of 10 regular transport ships, no more, no less. Up to 100 points worth of ships may be taken to defend the convoy for every two normal transports (or their equivalent) taken, or 150 points if the attacker uses one of the alternate tables on p.83. Before any escorting vessels are taken, at least two each of armed freighters and Q-ships from p.159-160 of Armada as well as two Rogue Trader fast clippers must be included in the fleet, with each pair of armed freighters or fast clippers counting as the value of a single regular transport (rounding down normally). Q-ships follow all their special rules, can be disguised as regular transports if desired and do not have to be revealed until they are fired upon. No more than two heavy transports may be taken, with each costing 40 points and replacing two regular transports. Any of the alternate transport variants listed on the Rogue Traders fleet list or in Armada may be taken, but Q-ships and escort carriers have zero transport value. After all transport variants are selected, any remaining available points may be spent normally on fleet warships to escort the convoy. All transports and civilian vessels must individually roll for leadership, they suffer -1 leadership, and they must roll for special orders and against leadership separately. They cannot be placed into squadrons.

BATTLEZONE

The convoy can be attacked near a planet or out in deep space so set up celestial phenomena in any mutually agreed-upon fashion.

SET-UP

Set-up for both the attacking and defending players are in the same manner as described in the Convoy Run scenario on p.74 of the Battlefleet Gothic Rulebook.

FIRST TURN

The defending player takes the first turn in the same manner as described on p.74 of the Battlefleet Gothic Rulebook. The defending player may decide how many ships start the first turn on his or her short table edge, and how many enter on the start of the second turn.

SPECIAL RULES

The rules for this scenario are as described on p.74 of the Battlefleet Gothic Rulebook. In addition, at the beginning of each defending player's turn after the first turn, the defending player rolls 2D6 against the following table. Unless otherwise stated, special orders called for by this table are assumed to have automatically passed and must be taken for that turn.

| 2D6 | ROLL RESULT |
|-----|--|
| 2 | Two regular transports (or a heavy transport if one is present) have engine trouble and lose 5cm speed for one turn. |
| 3 | A regular transport has engine trouble and loses 5cm speed for one turn. |
| 4 | An armed freighter turns normally towards the nearest enemy contact and travels full distance to engage the enemy! |
| 5 | The convoy maintains formation discipline and follows your commands. |
| 6 | An armed freighter and a Q-ship turn normally towards the nearest enemy contact and travel full distance to engage the enemy! |
| 7 | The convoy maintains formation discipline and follows your commands. |
| 8 | Two armed freighters and a Q-ship turn normally towards the nearest enemy contact and travel full distance to engage the enemy! |
| 9 | The convoy maintains formation discipline and follows your commands. |
| 10 | A fast clipper panics, comes to new heading directly away from the nearest enemy contact and travels full distance. |
| 11 | A fast clipper panics and immediately goes All Ahead Full. |
| 12 | PANIC! <u>All</u> transport ships test for All Ahead Full special orders, even if some ships fail. Roll leadership checks for each ship separately with no re-rolls allowed. |

GAME LENGTH

The battle continues until the last transport leaves the opposite table edge or is destroyed. If a transport leaves one of the long table edges for any reason, it counts as destroyed, though ships that don't count as transports (such as Q-ships and escort carriers) only count as disengaged.

VICTORY CONDITIONS

Victory conditions are similar to those described on p.75 of the Battlefleet Gothic Rulebook. However, use instead the table below to determine victory conditions. The point value of each transport that escapes is applied to the defender's tally when calculating victory points.

| ESCAPING TRANSPORT VALUE | VICTORY RESULT |
|--------------------------|-------------------------------------|
| 0-1 | Attackers Major Victory (+1 Renown) |
| 2-3 | Attackers Victory |
| 4-5 | Convoy Victory |
| 6+ | Convoy Major Victory (+1 Renown) |

SCENARIO TWO: THE HUNTER AND THE PREY

Sometimes Rogue Traders are contracted by the Imperial Navy or other, less forthright organizations merely for their firepower. Instead of escorting hapless merchantmen and cargo freighters, they are sent out into pirate-infested space to clear the space lanes for legitimate mercantile traffic. While some Rogue Trader captains have enough skill to subsist entirely on this kind of work, it is not uncommon for some to find themselves biting off more than they can chew, and the hunters can quickly become the hunted...

FORCES

Choose a point value for the hunting fleet. The raiders choose a value of up to 50% of the hunting fleet.

Hunting Fleet. The hunting fleet may not contain any battleships, and at least half the point value of the hunting fleet must consist of escorts, which can be organized in any mix of between two to six vessels.

Raiding Fleet. The raiding fleet may not contain any battleships, and at least half the point value of the raiding fleet must consist of escorts, which can be organized in any mix of between two to six vessels. This fleet is then split as evenly as possible, labeled Force 1 and Force 2. In addition to the 50% of the hunting fleet available to the raiders, they may purchase up to D6x10 orbital defenses from p.141-144 of the Battlefleet Gothic Rulebook.

BATTLEZONE

This scenario takes place near a pirate haven in the vicinity of two small planets or moons in close proximity to each other. Randomly determine the sunward edge on one of the two short table edges. Place two small planets closest to the opposite short table edge, no closer than 30cm to any table edge or to each other. Place D3 asteroid fields on every table quadrant, no closer than 15cm to either small planet. Additional celestial phenomena may be placed if desired in any mutually agreed-upon fashion.

SET-UP & FIRST TURN

The raiding player sets up first. Roll randomly to determine which of the two forces is on

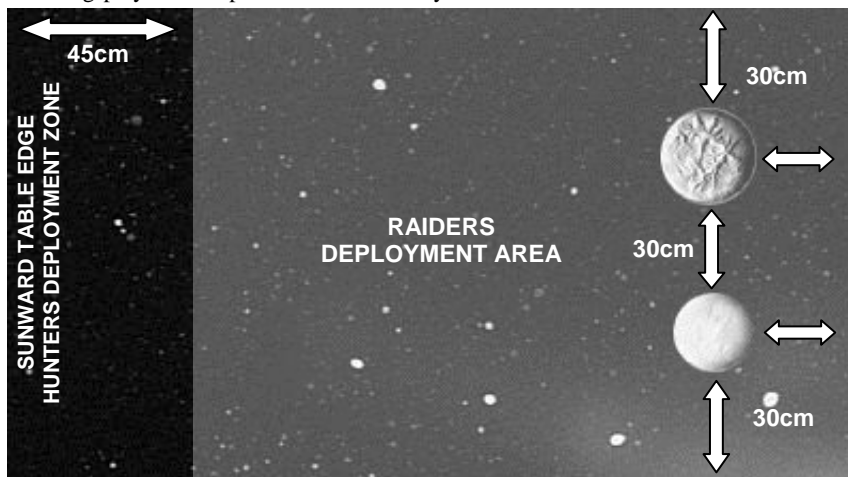

guard. Place a contact marker face down for every cruiser or escort squadron of at least two vessels in the guard force. Counters must be placed at least 30cm apart and may not be within 45cm of the sunward table edge. If all of the counters cannot fit on the table, counters may be stacked one on top of the other so that they are otherwise still at least 30cm apart. The other force is on standby is docked in low orbit at one of the two small planets- the raiding player secretly notes which one, which denotes the secret pirate base. The raiders orbital defenses may be placed anywhere on the table which is not within 45cm of the sunward table edge. Place a face-down counter to represent each of the raider's defenses. This is not dependent on being 30cm apart from other markers. The Hunting fleet then sets up and must be deployed within 15cm of the sunward table edge. The hunting player takes the first turn.

SPECIAL RULES

The raiders' face-down counters are activated by a hunting vessel moving within 30cm of them. Turn the activated counter face-up immediately as soon as the hunter vessel moves within 30cm and then completes its movement. Once the hunting player's movement phase is complete, the raider deploys ships for any counters activated. Any turn after the first turn, the raider may voluntarily activate one counter at the start of its own movement phase, or two counters if the defender is on special orders.

Activated Escort Squadrons: Place one ship from the squadron directly on top of the counter. Place the rest of the ships no closer to the hunters than and as close as possible to the first ship (they do not have to be in base contact). They can face in any direction the raider player chooses but must all face the same direction.

Activated Capital Ships & Orbital Defenses: Place the ship, defense, minefield (rolling normally for size) on top of the counter facing in any direction the raider player chooses.

Raiders Docked in Low Orbit: Vessels in low orbit are on standby and may not move out of low orbit until they pass a leadership test. This is not a command check such as for special orders so ships that fail do not prevent others from testing if a roll fails. Units moving out of low orbit cannot take special orders in the same turn except Brace for Impact.

GAME LENGTH

The battle continues for ten turns or until one side's fleet is destroyed or disengages.

VICTORY CONDITIONS

Both hunters and raiders score standard victory points for destroying and crippling ships, but the hunter receives no victory points for raider vessels disengaging. However, the hunter earns additional victory points equal to the value of his or her ships that are in low orbit of the raiders' planet at the end of the game, as they can quickly attack and capture the raider base. The raider scores bonus victory points equal to 10% of the points value of any raider ships that disengage by the end of the game (unless crippled).

SCENARIO THREE: THE GAUNTLET

In wilderness space, just traversing from one star system to another can be a hazard in and of itself. It is not unheard of for a Rogue Trader cruiser and its attendant fleet to jump out of the warp and back into normal space just to find themselves in the midst of a firefight or at the wrong end of a hostile fleet. In such situations there is not enough time to fleet to flee back into the warp, and Rogue Trader captains must rely on their wits, the skill of their crews and the aim of their guns to see their way through.

FORCES

Defending Forces. A single Rogue Trader cruiser and no more than three escorts are selected by the defending player.

Attacking Forces. Forces are selected as desired by the attacking player, but the total point value must not exceed the total value of ships selected by the defender. These forces can only be made up of escort squadrons of at least two ships each. All attacking ships must be divided into at least two units, but can be more if desired.

BATTLEZONE

This scenario takes place out in deep space near a point where ships typically jump into and out of the warp. Use the deep space celestial phenomena generator, ignoring any result that produces a planet.

SET-UP

The attacking player divides his or her fleet into two or more units and represents each of with face-down contact markers, which can be placed anywhere desired within 45cm of the table edges. When all attacker contact markers are laid down, the defending player rolls a D2 to determine which short table edge it will be entering from, then places his or her ships against one short table edge, no closer than 45cm from any long table edge.

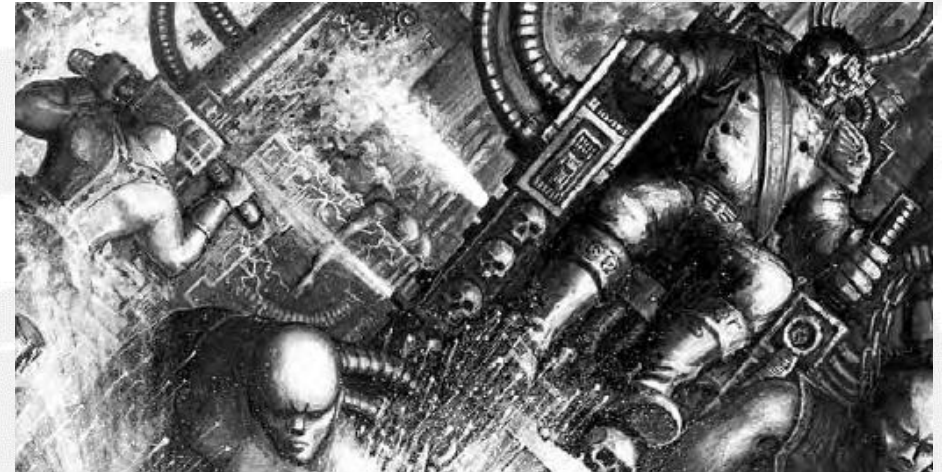

SPECIAL RULES

The attacker's face-down contact markers are activated by any of the defender's ships moving within 30cm of them. Any turn after the first turn, the attacker may voluntarily activate one counter at the start of its own movement phase, or two counters if the defender is on special orders.

FIRST TURN

The defending player takes the first turn by moving off the defender's table edge. All defending units move off the table edge during the first turn.

GAME LENGTH

The battle continues until all the defender's ships either escape off the opposite short table edge or are destroyed.

VICTORY CONDITIONS

Victory points are calculated normally. In addition, the defender earns a major victory (+1 renown) if the cruiser departs the opposite short table edge without being crippled. The attacker earns a major victory (+1 renown) if the cruiser is destroyed.

Note: This scenario is particularly well-suited for experimenting with new homebrew ship designs. If you are wondering what your new ship design and profile is worth in points, send it through the gauntlet and see how it fares, ideally against ships from several different fleet lists! If it handily defeats all arrayed against it, you guessed its point value too low. If it routinely gets destroyed in one or two turns, you guessed too high.

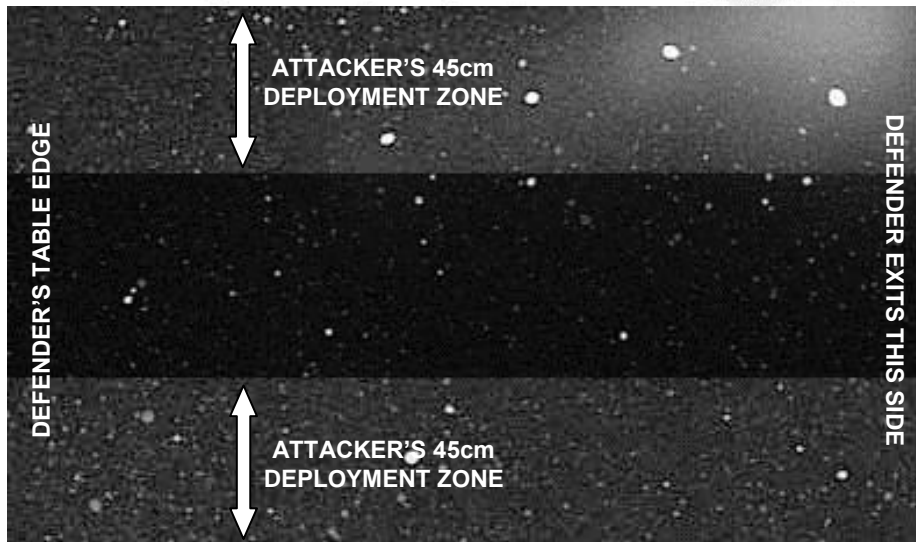

SCENARIO FOUR: EXPLORER'S PRIZE

Every once in a while, a Rogue Trader occasions upon or ascertains the approximate location of a relatively intact starship hull, either through information dearly traded for, contacts developed through their many travels or just by sheer dumb luck! The Adeptus Mechanicus will pay handsomely for such a prize, particularly if it should be Xenos in origin or possess some manner of archaeotech. Unfortunately, finding it is only the beginning of the problem; Rogue Traders may find they aren't the only souls seeking out such a valuable treasure, and just capturing and keeping the derelict vessel may result in having a fight on one's hands!

FORCES

Both sides have an equal point value as determined by the applicable fleet list. In addition, there is a derelict ship that at the start of the game does not belong to either player.

Derelict Ship: This ship can be a cruiser-type vessel from any fleet except Necrons or Tyranids agreed upon by both players or rolled for randomly.

BATTLEZONE

This scenario takes place in the outer reaches. In lieu of generating celestial phenomena normally, determine the sunward edge randomly, then place a single asteroid field no more than 30cm wide down the full length of one long table edge.

SET-UP

Decide by initiative roll which fleet will set up first. Both fleets set up no more than 15cm from opposing short table corners on the other side of the table from the asteroid field. Additional celestial phenomena may be placed if desired in any mutually agreed-upon fashion, ignoring any result that produces a planet.

FIRST TURN

First turn can be determined by initiative roll normally.

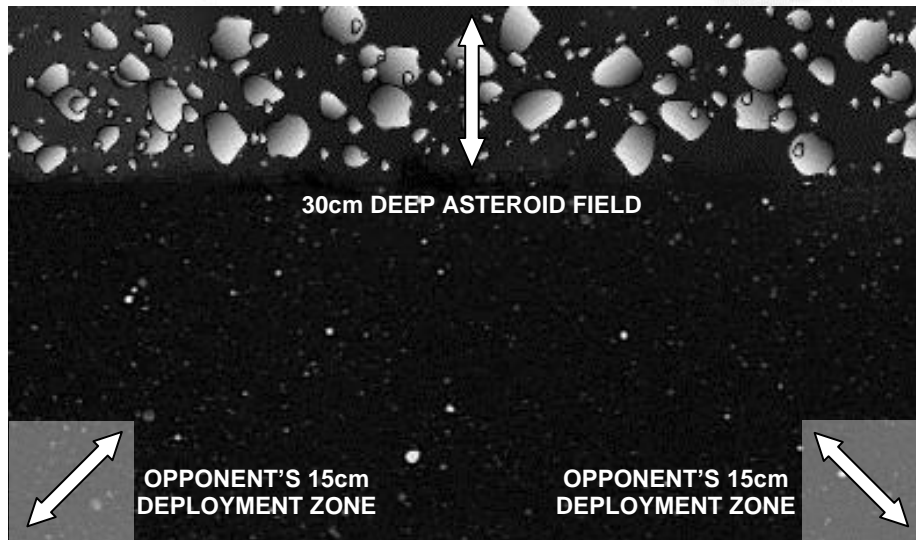

SPECIAL RULES

Besides the obvious objective of slugging it out with your opponent, the derelict ship must be located, boarded and escorted off the table. At the beginning of each player's turn, the player must roll a leadership test normally for any ships in contact with the asteroid field. The owning player rolls a number of D6 for every ship the player had in the asteroid field for one full turn. To this roll add +1D6 for every three attack craft markers (or portion thereof) in the asteroid field for one full turn. On the first roll of 6, the derelict ship is discovered! The owning player may elect which ship actually discovered the derelict, then roll a scatter dice and 3D6. Ignore any "Hit" rolls and place the derelict ship 3D6 away from the ship that discovered it in the direction pointed to on the scatter dice, facing any direction the discovering player desires. Ignore any roll result that sends the derelict ship off the table edge or outside the asteroid field- it will end up no farther than just inside the asteroid field or just before the far table edge.

The first capital ship or escort squadron of at least four vessels that makes base contact with the derelict ship is considered to board it for free. Teleporters and assault boats cannot be used for this initial boarding action because they cannot bring enough of the required crew and equipment aboard. The ship begins with -1Ld of the highest leadership of what ships or escort squadrons first boarded it, and the boarding ship or escort squadron loses -1Ld for the amount of crew and officers required for the boarding party. Normal boarding rules apply for any subsequent opposing boarding action, with the derelict ship taking -1 in addition to any other modifiers, though race modifiers for the crew that boarded it apply normally (such as Chaos or Space Marines). The ship begins on standby and must make a leadership test to be activated. Both shields and turrets (or equivalent) are functional, and when it is finally activated it may move normally, but it starts off with one port, starboard, prow and dorsal critical damage (or equivalent). This must be repaired normally before any weapon systems can be used, and it may not use any attack craft even if its launch bays are repaired.

Once the ship is activated, the owning player may immediately begin navigating it out of the asteroid field. Because it is being carefully monitored by both sides, it cannot disengage normally and must make its way to the opposite long table edge to make good its escape!

GAME LENGTH

The battle continues until the derelict ship leaves the opposite long table edge or is destroyed.

VICTORY CONDITIONS

Victory points are calculated normally. In addition, the player that captures the derelict ship and navigates it off the table earns a major victory (+2 renown), even if it is crippled, along with victory points equal to the starting value of the ship. Neither side earns any victory points for the derelict ship if it is destroyed, though its value as a capital ship hull remains unchanged if one player holds the field at the end of the battle.

SCENARIO FIVE: SPACE HULK!

Every Rogue Trader dreams of discovering the holy grail of prizes – a space hulk! Riches beyond imagining and all manner of archeotech can be found among the conglomerated wrecks of derelict starship hulls, but the promise of untold wealth comes fraught with many dangers. Many such space hulks are almost inevitably infested with Orks or worse, and only a complete and utter fool would hazard his or her self and ship by exploring such a prize without help- a LOT of help...

FORCES

Defending Forces. The defending fleet has a Space Hulk it recently captured and is still in the process of securing. The Space Hulk starts the game with Ld6, 2D6 hits subtracted from its starting damage (40HP) and has working turrets and shields, but all weapon systems are off-line. It is being escorted by a Rogue Trader cruiser, an allied battleship, at least three allied cruisers, and escorts in any mix desired. The entire escorting fleet cannot exceed 1200 points (not including the Space Hulk). All escorting capital ships are at -1Ld for the amount of crew and equipment they have aboard the Hulk.

Attacking Forces. Attacking forces are randomly generated. Do not use the alternate attacker threat tables on p.83 for this scenario. To determine the total strength of the attacking forces, make D3+5 rolls against the table below from the attacker's fleet list.

| D6 | ROLL RESULT |
|----|--|
| 1 | Three attack craft or deadfall torpedo counters. |
| 2 | A squadron of escort ships worth up to 100 points. |
| 3 | A squadron of escort ships worth up to 150 points. |
| 4 | A squadron of escort ships worth up to 200 points. |
| 5 | One capital ship worth up to 210 points. |
| 6 | One capital ship worth up to 250 points. |

BATTLEZONE

The Space Hulk can be attacked near a planet or out in deep space so set up celestial phenomena in any mutually agreed-upon fashion.

SET-UP

The Space Hulk must be present on the table at the start of the game. Ships of the escorting force may start the game on the table with the Space Hulk or may enter the table at the start

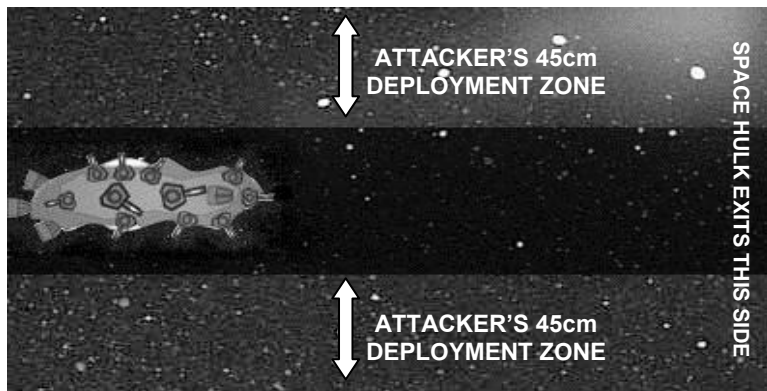

of the second turn in any mix and order desired. The attacking player sets up in the same manner as described on p.75 of the Battlefleet Gothic Rulebook.

FIRST TURN

The defending player takes the first turn in the same manner as described on p.74 of the Battlefleet Gothic Rulebook. The defending player may decide how many ships start the first turn on his or her short table edge, and how many enter on the start of the second turn.

SPECIAL RULES

The Space Hulk must survive to travel off the opposite table edge. In addition, at the beginning of each defending player's turn after the first turn, the defending player rolls 2D6 against the following table. The roll result takes effect immediately.

| 2D6 | ROLL RESULT |
|-----|--|
| 2 | Chaos! The boarding teams run into a squad of Chaos renegades, and a firefight takes place aboard the Hulk, causing D3 damage. |
| 3 | No effect. |
| 4 | One dorsal lance battery strength is brought on-line (max 4, then re-roll result). |
| 5 | Three weapons batteries are brought on-line (all four quadrants). |
| 6 | Two torpedo launchers are brought on-line (all three quadrants). |
| 7 | Orks! The boarding teams run into a mob of Orks, and a firefight takes place aboard the Hulk, causing D3 damage. |
| 8 | Two torpedo launchers are brought on-line (all three quadrants). |
| 9 | Three weapons batteries are brought on-line (all four quadrants). |
| 10 | One dorsal lance battery strength is brought on-line (max 4, then re-roll result). |
| 11 | No effect. |
| 12 | Tyranids! A brood of Genestealers are encountered aboard the Hulk, and that entire section must immediately be cleansed, causing D6 damage. Note how many times this result is rolled. If this result is rolled three times in the game, the Space Hulk is deemed too dangerous to be recovered and must be destroyed! |

GAME LENGTH

The battle continues until the Space Hulk leaves the opposite table edge or is destroyed. If the Space Hulk leaves one of the long table edges for any reason, it counts as destroyed.

VICTORY CONDITIONS

Victory points are calculated normally. In addition, if the Space Hulk is safely navigated off the opposite table edge, the defending player earns a major victory (+1 renown) regardless of how many hits are remaining, along with victory points equal to the starting value of the ship (50% if crippled). If the defender must destroy the Space Hulk, it gains +1 renown for any recovered technology but only gains victory points if the Hulk is destroyed. If the Space Hulk is destroyed for any reason, it is a major victory for the attacker (+1 renown).

SCENARIO SIX: THE VOID MALEVOLENT

Rogue Traders rarely if ever are graced with a Warrant of Trade with the power and authority it bestows based solely on their wealth or social station. More often than not, a Warrant is granted on condition that a critical task or mission be performed, such as escorting a vital convoy through pirate-infested space or cleansing a given system or group of systems of some minor alien menace. However, ancient evils stalk the abyss, against whom all they encounter are little more than prey to be consumed or foes to be destroyed.

FORCES

This is a three-player battle. Two sides have an equal point value as determined by their applicable fleet lists. In addition, there is a third fleet that plays the Foe Malevolent.

Foe Malevolent: This fleet is 1.5 times larger than the point value of either one of the two primary opponents. Ideally this fleet would be Dark Eldar, Necrons or Tyranids, but it can be any fleet desired as long as it is played as an enemy of the other two fleets.

BATTLEZONE

The Foe Malevolent may have been hiding in the glare of a nearby sun, in low orbit of a planet or lost in the clutter of swirling asteroid fields. Set up celestial phenomena in any mutually agreed-upon fashion.

SET-UP

Both primary fleets set up on opposite long table edges in the same manner as the Cruiser Clash scenario on p.68 of the Battlefleet Gothic Rulebook. The third fleet does not set up for D3 turns. When it does set up, it does so anywhere along a random short table edge.

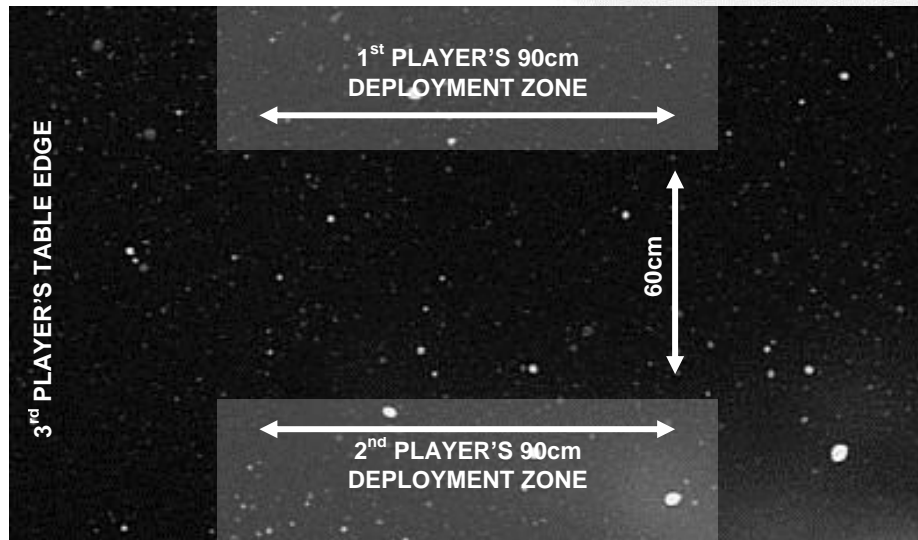

FIRST TURN

The two primary opponents determine first turn using initiative rolls or any other agreed-upon manner. After D3 turns, game play stops as the third player sets up any desired portion of his or her fleet along the randomly-rolled short table edge. The third player then goes first for the remaining turns of the game (see special rules). Any ships not set up at the beginning

of the third player's turn must enter the game along the same table edge at the beginning of the third player's next turn.

SPECIAL RULES

The third player moves his or her ships in any desired fashion or order as prescribed by its given fleet list. Only the closest enemy ships may be targeted for shooting by the third fleet, though ordnance (if applicable) may target enemy ships in any manner or fashion allowed. With the exception of only shooting the closest targets, all normal and special rules available to the third fleet may be used as applicable.

Because ordnance movement can be complicated by the introduction of a third player, the order of play after the third player sets up is outlined on the following table. Turns subsequent to D3+1 continue on in the same order and sequence.

| TURN D3 | | MOVEMENT/SHOOTING SEQUENCE |
|------------------------|--|---|
| 3 rd Player | Moves ships, conducts shooting, launches ordnance. | 2 nd Player then moves ordnance a second time. 1 st Player ordnance remains in place. |
| 1 st Player | Moves ships, conducts shooting, launches ordnance. | 3 rd Player then moves ordnance a second time. 2 nd Player ordnance remains in place. |
| 2 nd Player | Moves ships, conducts shooting, launches ordnance. | 1 st Player then moves ordnance a second time. 3 rd Player ordnance remains in place. |
| TURN D3+1 | | MOVEMENT/SHOOTING SEQUENCE |
| 3 rd Player | Moves ships, conducts shooting, launches ordnance. | 2 nd Player then moves ordnance a second time. 1 st Player ordnance remains in place. |
| 1 st Player | Moves ships, conducts shooting, launches ordnance. | 3 rd Player then moves ordnance a second time. 2 nd Player ordnance remains in place. |
| 2 nd Player | Moves ships, conducts shooting, launches ordnance. | 1 st Player then moves ordnance a second time. 3 rd Player ordnance remains in place. |

GAME LENGTH

The battle continues for eight turns or until all but one fleet disengages or is destroyed.

VICTORY CONDITIONS

Victory points are calculated normally. Escorts count for victory points individually instead of per squadron. Capital ships count normally. However, their full value in victory points only goes to a player if they reduce a ship from zero damage to zero remaining hits without any assistance from another player. If another opponent causes even one Hp damage upon a capital ship, then its victory points must be split equally between the two opponents that caused damage to or helped destroy the capital ship.

Players #1 and #2 determine victory by gaining the most victory points, provided they earn more victory points than they lose before the end of the battle. Player #3 only wins the battle if both other players lose more victory points than they earn.

NEW THREAT ALERT!

The vast majority of the minor alien races encountered by the Emperor's servants have not progressed to a level of starship technology possessing any hope of challenging the supremacy of the Imperium of Man. Some however have nonetheless developed quite capable capital ships, such as the reclusive Demiurg, which fortunately demonstrate little evident animosity toward Imperial interests. There are other minor races however that also possess a small number of capital ships that, while inferior to Imperial designs, nonetheless present a clear and present danger in the hands of those who wish only harm to mankind.

FRA'AL BATTLESHIP 250 Points

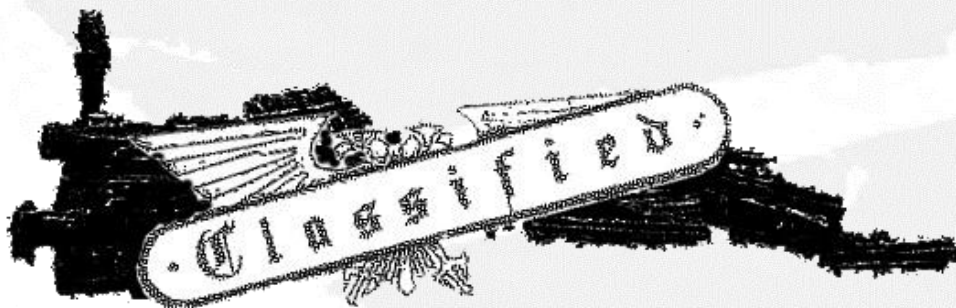

The Fra'al are an enigmatic race, one of a very few of the minor alien races that have managed to maintain a near-constant state of hostilities against the Imperium yet persistently manage to avoid complete extermination under the weight of superior technology and vastly greater numbers. The first detailed records by the Ordo Xenos of the Fra'al as a distinct threat date back to 420.M37, though sensor log pict-captures indicate they have harassed Imperial shipping for at least a millennia beforehand. They are consummate pirates of the basest character, managing to eke out an existence by slinking away to new hunting grounds at the merest hint of comparable firepower arrayed against them. This was not always the case, and at one point their predations were severe enough to surpass Stabilis Mandates and warrant Imperial sanction, culminating in the Battle of Fraga'Tral in 312.M39 that saw the destruction of a number of their vessels.

After centuries of few recorded raids and relatively little contact, pirate activity by the Fra'al once again surged through much of Segmentum Obscurus during the Gothic War, as is typical of Xenos freebooters whenever a region of space is embroiled in strife. At the conclusion of that conflict when pirate scum of all races were hunted down for extermination, the Fra'al dispersed over an ever-widening area of space approaching the Northern Rim and Eastern Fringe in small flotillas, led by at most one or two of their battleships serving as pirate mother ships of a sort. Dispersed in this way they have become difficult to pin down and have never again exceeded Stabilis Mandates in any one sector. These powerful ships deploy sparingly and raid infrequently, though Fra'al activity has once again increased during the 13th Black Crusade.

| TYPE /HITS | SPEED | TURNS | SHIELDS | ARMOR | TURRETS |
|---------------------------|-------|-------|--------------------|-------|--------------------|
| Battleship/10 | 20cm | 45° | 3 | 5+ | 3 |
| ARMAMENT | | RANGE | FIREPOWER/STRENGTH | | FIRE ARC |
| Port Weapons Battery | | 45cm | 14 | | Left |
| Starboard Weapons Battery | | 45cm | 14 | | Right |
| Dorsal Lance Battery | | 30cm | 3 | | Left/ Front /Right |
| Prow Lance Battery | | 30cm | 3 | | Front |

Special Rules: The Fra'al utilize a complex targeting matrix that greatly improve the accuracy of their weapon batteries at long range; they treat all targets less than 30cm as closing and do not suffer a column shift for firing at targets greater than 30cm. Fra'al battleships cannot use Come To New Heading special orders.

Using Fra'al Battleships

The Fra'al are exceedingly xenophobic and will not lightly countenance risking their few capital ships in an alliance with any race. While they may well each be accompanied by a squadron of their escorts in larger raids, they can just as well operate singly or in pairs. Using only the profile above, they may be used as a substitution for an enemy in any scenario where the chosen or randomly selected threat is a ship worth up to 250 points. Additionally, up to two ships in a pirate fleet may be Fra'al battleships, rolling for leadership normally. However, they count as cruisers against the fleet list, they may not use any fleet re-rolls, and they will attempt to disengage if crippled (+1 Ld bonus when doing so).

There is no limit to the creativity you are free to exercise when building a Fra'al battleship, though it should of course outwardly resemble whatever you are using for Fra'al escorts, should you decide to model those as well.

STRYXIS CARAVAN VESSEL 80 Points

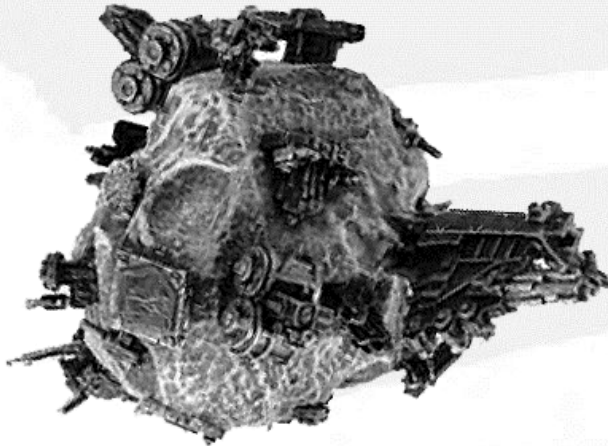

The Stryxis have only been encountered among the sectors in the vicinity of the Koronus Expanse, where their nomadic caravans of dilapidated ships are open to anyone willing to barter something of value. It is unknown from what system the Stryxis hail from, and they are reticent about all but the most basic details of their enigmatic race. Vaguely canine in appearance, they have an eccentric and obscure culture, but by nature they are voracious traders that will not hesitate to make contact with other races. While they are a useful resource for a cunning Rogue Trader, their allies today may be foes tomorrow. They sell their goods and services to the highest bidder, having few scruples and no loyalty. They salvage any hulks they encounter and have developed weapons optimized for capturing rather than merely destroying enemy vessels.

Using Stryxis Caravan Vessels

The Stryxis are aggressive merchants that are quick to salvage or trade for whatever technology they encounter, which they gather into their caravan vessels, essentially hollowed-out asteroids they travel abroad in caravans that function both as capital ships and impromptu trading posts. Using only this profile, two or three may be used as a substitution for an enemy in any scenario where the chosen or randomly selected threat is a capital ship of a given point limit. Additionally, up to four ships in a Rogue Trader or pirate fleet may be Stryxis Caravan Vessels, rolling for leadership normally. They do not count as cruisers against their respective fleet lists, but they may not use any fleet re-rolls.

Caravan Vessels utilize powerful tractor fields to stay together and must always be grouped in a straight line (not necessarily aligned with their direction of movement) no more than 10cm apart. Caravan Vessels so grouped may only separate if at least one of their number is destroyed. A Rogue Trader fleet accompanied or allied with Space Marines may not take Stryxis Caravan Vessels.

| TYPE /HITS | SPEED | TURNS | SHIELDS | ARMOR | TURRETS |
|--------------------------|-------|--------------------|------------|-------|---------|
| Defense/8 | 10cm | Special | 2 | 5+ | 2 |
| ARMAMENT | RANGE | FIREPOWER/STRENGTH | FIRE ARC | | |
| Ghost-Light Macrobattery | 45cm | 10 | All Around | | |
| Ghost-Light Lance | 30cm | 3 | All Around | | |

Special Rules: The Stryxis rely on weapon technology called “Ghost-Light” that when striking unshielded vessels inflict horrific crew casualties while only minimally affecting a ship’s hull. In damage terms they function as standard weapon batteries and lances in all respects but will not roll for or inflict critical damage. Stryxis caravan vessels are unique constructions and follow the special movement rules outlined below. They are bitter enemies of the Eldar and cannot ally with any fleet that contains Eldar vessels.

MOVEMENT: Because they are basically large lumps of rock with engines studded all over them, Caravan Vessels don’t move in the same way as normal ships. In their Movement phase Caravan Vessels travel 10cm forward in a straight line, no more, no less. Caravan Vessels may not turn or use *Burn Retros* or *Come to New Heading* orders. On *All Ahead Full* orders Caravan Vessels move an extra 2D6cm in any direction at the end of their move. If this causes them to move 10cm or more in a different direction to the one they are travelling in, this becomes their new direction of travel. This is seen more clearly in the diagrams to the right.

Due to their low speed and considerable momentum, Caravan Vessels which are crippled or moving through Blast markers do not reduce their speed. Caravan Vessels in the gravity well of a planet or moon may make free turns like an ordinary ship (45°) and/or place themselves in a stationary or low orbit. They may undergo *All Ahead Full* special orders for free.

CRITICAL HITS: Caravan Vessels lack the complex systems of true spacecraft, so critical hits are not rolled on the Critical table. Instead each critical hit inflicts +1 point of damage.

CATASTROPHIC DAMAGE: When a Caravan Vessel is reduced to 0 Damage it breaks up. Do not roll for Catastrophic Damage, instead the vessel is replaced by four Blast markers.

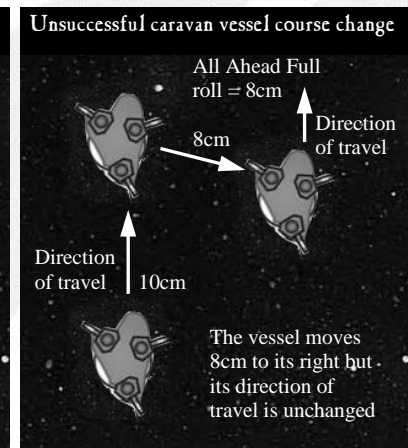
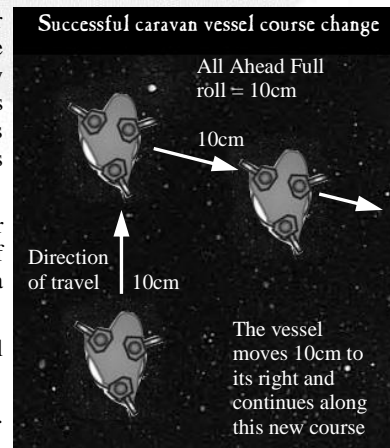

THE POWERS OF CHAOS

CHAOS FLEETS IN BATTLEFLEET GOTHIC

THE CHAOS POWERS

There are many paths to damnation, and over its long, sorry history Mankind has trodden all of them. The four greatest are Khorne, Nurgle, Slaanesh and Tzeentch, each a component fragment of Chaos and a route to Mankind's ultimate damnation. Khorne is the Blood God, in whose name men kill. Nurgle is the Lord of Decay, by whose will men hide from the mortality they deserve. Slaanesh is the Prince of Pleasure, in whose empty promises men find escape from the sorrows of the world. Tzeentch is the Changer of Ways, by whose gifts men unwisely hope to change the inevitable fate which befalls them. Each of these routes to damnation, and many more, may be followed, often by men who begin with good intents. To wish to escape death is perhaps understandable, yet it sorely overlooks the true destiny of man and entirely neglects to consider that a man, a creature born mortal, must surely pay for immortality. To bring change, to better oneself, is perhaps equally understandable, but when that change is wrought by lies, trickery and manipulation it is change unjustified, unearned and illegitimate, and thus not Man's true entitlement – merely a costly lie for which he must ultimately pay. So on leads the path to damnation.

Marks of Chaos

Once a man begins down the path to damnation, he is marked by it. Slightly at first, but marked nonetheless. A man might escape death, might survive the most virulent of plagues, but the boils and sores which strike at his flesh will scar him, mark him, nonetheless. These are physical marks, and perhaps nothing more than the marks made upon all men by the lives they lead, but once a man comes to know the path he is upon – once he can call its name, and the name of the power that leads him down it – then the mark may become something more. It becomes as a badge, a mark not merely

inflicted upon him scar-like and accidental, but passed to him by the gods, taken and embraced knowingly, held up as a mark of devotion, of desire and of damnation. To have reached such a point is to no longer question one's own path, or one's reason for being upon it, and so damnation in itself becomes an end or a goal, not merely a risk run by men of good heart doing their best. So it is then that their mark becomes a mark of damnation, a mark, indeed, of pure Chaos. With such a mark of favour comes many gifts – gifts the unwary may well believe they can use to their own ends: to escape death, to change the things they hate about the world, to bring them the joy they deserve and so on. Each of the Gods of Chaos has their own mark, each a totem of that god's will and bringing with it the most unique gifts of that god. The effect of these gifts is far from uniform. Some may be random and uncertain, perhaps even unwelcome, the blessing of Chaos pure and undivided. Others are brought about by favour of one particular, or patron, god and so will take a form pleasing to the god and rewarding to the servant. The form of such patronages depends entirely on the chosen god and their unholy will.

The Shape of Change

Just as the powers of Chaos visit their warped and twisted blessings upon those followers who prove themselves worthy, so too do their gifts fall upon the great and aged machines devoted to them. A ship's form, its very materials, may be warped by the touch of Chaos to take on a form ever more pleasing to its patron. So it is that a ship might come to truly bear the mark of its god. It is not merely the will of a god that can alter a ship, though. A dedicated and worshipful crew will lavish much time on their vessel, reshaping it in their god's image, branding great runes all across it, covering it in colours, symbols, substances or geometries favoured by their god as testament to their fervoured devotion. By weird enchantments and dark rituals, daemons,

spirits and other entities likewise in their service of their patron may be summoned up, or even gifted whole areas of the ship, invited to dwell within its engines, sustained in the material realm by the same bound psykers and warp engines that once allowed the ship safe passage through the Immaterium. Alone amongst the material creations of man, his magnificent starships are designed to travel both the material and the immaterial, and so offer a sanctuary to daemons which cannot be found elsewhere. These beings of Chaos might slumber within a ship's guns, launching fire from them with an unnatural fury; sweep formlessly throughout the ship's decks like a wailing ghost, driving off would-be boarders; or even lurk deep within the hull of the vessel itself, binding their own ancient malice with the intangible, yet no less resolute, will of the aged machine, birthing a vessel with a true heart of Chaos.

The powers of Chaos, and likewise their fleets, are myriad. Abaddon may have led a fleet of Chaos Undivided during the Gothic War and the 13th Black Crusade, but there are nonetheless numerous fleets dedicated solely to the service of one of the Great Powers of Chaos – Khorne, Nurgle, Slaanesh and Tzeentch.



KHORNE

When the tribes of Man first travelled abroad upon the lands and seas of ancient Terra, when first they met their distant kin, their first words were not of peace and brotherly love. They were of anger, hatred and rage. This is the tragedy and saddest irony of Mankind; that in a universe poised to destroy him at every turn, in a world where his only friend is his brother; Mankind is as likely to turn his weapon upon his fellow man as upon his enemy. Khorne is the manifestation of this violent,

irrational aspect of human nature. He is the living embodiment of every hate-fuelled blow, every brutal killing, every pointless murder ever committed in the long, sad history of the Human race. The Blood God sits upon a brass throne atop a mountain of skulls. The remains are those of his victims and his champions both, for he cares not whose blood is shed in his name. The skull mount forms an island amidst a vast ocean of blood: the living sacrificial essence of every victim of violent death throughout the ages. Khorne is generally the dominant Chaos god, for he draws on the rawest, most elemental forces of human nature. His armies heave with those ensnared by notions of courage, honour, martial pride and revenge: all such concepts lead ultimately to the base of the Blood God's throne.

On every one of the million and more worlds that make up the Imperium there exist bodies of armed men. From the smallest garrison to the most populous fortress-world guarding an entire sector, warriors gather and train. Amidst these groups grow elite cadres, warrior-cults for whom martial pride and honour is all. Honour may give these men strength on the field of battle, but against Khorne it will prove their undoing, for pride becomes conceit in the Realm of Chaos, and from conceit it is but a short step to tyranny. The Imperium of Man is driven by war. Upon thousands of worlds, a billion warriors strive for nothing more than slaughter. Amidst bloodshed on such a scale Khorne finds his followers, for when war has stripped a man of all decency, compassion and humanity, then his soul is open wide to the howling, hate-driven oaths of the Blood God.

The antithesis of Khorne is Slaanesh. The Blood God rails against his rival's decadence and love of luxury. Where a follower of Khorne conquers through the application of crude, brutal force, a champion of Slaanesh delights in each delicate stroke of the blade, only releasing his victims from his attentions when they are wasted and used.

Khorne also finds an opposite in Tzeentch, the Lord of Sorcery, whose elaborate scheming and use of magic he scorns as cowardly.

Chariots to Slaughter

To all but the blindest and most deranged of Khorne's followers, the need for ships to transport them across the stars is obvious, though beyond such cold utility even the most ancient of vessels deserves little more reverence. To Khorne's followers, such vessels are little more than steeds, chariots even, to take them to slaughter. Where other gods might visit their blessing equally upon their followers both man and machine, Khorne cares little for the beasts of steel, and it is instead upon the deranged and bloodthirsty warriors that slay in his name that Khorne's blessing falls. Khorne's lust for blood eschews as cowardly and unworthy long-ranged guns of many traitor vessels. Even a perfectly well-armed and equipped warship of Khorne may forgo all firing as its frenzied crew instead plough furiously forwards, impatient to fall upon their enemy hand-to-hand. With little love of magic or arcane technology, followers of Khorne are often equally loathe to rely upon such tricks as teleportation and instead enact the will of their god with their frenzied boarding actions. So insanely devoured by the lust for blood are some that they forsake any form of shooting entirely, and instead populate drifting hulks, from where they can fall upon enemy fleets, or even worlds, in an unstoppable tide of boarding actions. Khorne is not blind to the need for firepower, though he gives no favor to it, and his fleets remain rigidly utilitarian in this regard, willing only to utilize those weapons and those tactics which will ultimately bring them closer to their target, closer to the slaughter.

SLAANESH

The hearts of mortals harbour the darkest of desires, and it is in Slaanesh that these desires find expression. Every culture imposes limits and



standards on its peoples: Slaanesh is the manifestation of the desire to stretch these limits to breaking point, to exceed them, and to wallow in the act of violating ever more of civilized society. Slaanesh is the youngest of the Chaos gods, having burst into being some ten thousand years ago at

the moment of the Fall of the Eldar. Eldar society had, over the course of many centuries, regressed to a state of hedonism and self-indulgence, where every whim could be satisfied in an instant. The very nature of the Eldar race made them susceptible to excess. In one cataclysmic climax, almost the entire race was destroyed and Slaanesh was born with such force that the Eye of Terror came into being and the warp storms isolating Terra were driven away.

Slaanesh whispers to Man in many different voices; each whisper attuned to the most secret desires of the listener. Many desire perfection, whether in the intellect, the body or in ability, and Slaanesh will grant these individuals the power and drive to hone their desires to the utmost excellence. The artist will produce works beyond Human comprehension, the narcissist hones their visage so that other mortals are driven insane with desire, and the warrior develops such abilities that a casual gesture may decapitate the mightiest of foes. To the followers of Slaanesh, the material world is a riot of color, sound and sensation. However, their senses soon become accustomed to these levels of stimulation and they are driven to extremes in search of the slightest fulfilment. The followers of Slaanesh often exhibit the utmost physical perfection to the naked eye, and on the exterior it may be true that no mortal is capable of such beauty. But the soul of each follower screams in eternal torment, as the gifts bestowed by the Prince of Chaos are purchased at a price as high as that demanded by any other Chaos god: eternal damnation.

Slaanesh may appear as male, female, hermaphrodite or androgynous. Whichever form he takes, his physical beauty is such that no mortal may look upon him and resist the urge to submit. Slaanesh is the rival of Khorne, who he sees as crude and unsophisticated. The Prince of Chaos does not have the resources to seriously challenge the Blood God; the very nature of his power is such that it will ultimately expend itself long before Khorne's hordes have satisfied their bloodlust.

The Floating Palaces of Slaanesh

Those vessels favored by Slaanesh are nothing short of palatial – the finest and most delicately crafted of galleons, carefully maintained and lovingly restored, their every inch bedecked in the most precious metals and glittering gems, smothered in the richest and most extravagant of dressings, details and iconography, decorated with the most exquisite portraiture, sculpture and art, invariably portraying acts of the most perverse kind of beauty. Within the followers of Slaanesh both slumber in a malaise of ecstasy, drawing themselves into action only to further their exhausting pursuit of pleasure. Such are the delights within that these Palaces of Slaanesh are as beacons of seduction to those that look upon them. Vessels nearing them might find their comm-links bombarded not by the expected hails of identification, allegiance and intent, but rather by a cacophony of giggles, screams, moans and gasps, both disorienting and enchanting, broadcast by the fickle followers of Slaanesh, seemingly uncaring, perhaps even unknowing, who watches them in their revelry. For those whose inadvertent frequency scanning or attempts at communication open up such a channel, it is a voyeuristic gaze at pleasure beyond comprehension and an aural enticement that would bring the weak to their knees. But pain is pleasure also, as the incautious should not forget. To turn their guns upon the entranced crews of nearby ships is as much ecstasy to the followers of Slaanesh as it is agony to their victims. To board their vessels and

take what captives may be found for purposes that may not be spoken of, to Slaanesh, not remotely a betrayal of the apparently harmless sensation which first proved so alluring to those same unwary victims. Such is the fate of any fool enough to stray close to the screaming Palaces of Pleasure which are the vessels of Slaanesh.



TZEENTCH

Tzeentch weaves the threads that connect every action, plot and subtle intrigue in a galaxy-wide game of manipulation and subterfuge. At the end of each of these threads writhes the ensnared soul of a Human puppet; his servants and agents who believe they serve the Lord of Sorcery in mutually beneficial pacts. The truth is that Tzeentch's every action is planned with its ultimate goal as his own establishment as the pre-eminent power in the Warp. Of course, the very nature of the Lord of Entropy is such that, were he to attain this goal, he would still strive for turmoil and change. Tzeentch exerts his influence in the mortal realm through subtle manipulations and devious ploys. His victims are sorcerers drawn by the promise of forbidden knowledge, politicians lured by the power to outmaneuver their opponents. His power is sorcery, and as all sorcery flows from the fount of the Warp, so too is Tzeentch the master of

that twisted medium. Tzeentch embodies mutability and change, the drive to evolve and manipulate. This spirit is present in the essence of every living creature from the first division of cells within the womb to the ultimate craving for survival. It is in the hearts of those with the strongest desire to prevail that Tzeentch whispers his insidious promise; offering a means to life eternal to those unwilling to accept death and oblivion as inevitable.

The main rival of the Lord of Sorcery is Nurgle. Where Tzeentch seeks to build and evolve, the Lord of Decay desires only to break down and dissolve. On innumerable occasions Tzeentch's intricate plots have been foiled by Nurgle's malign influence, and the two gods' servants clash as often with each other as with their mutual enemies. Despite Tzeentch's rivalry with Grandfather Nurgle, he is nonetheless the god with the most influence over the others. At times, the Chaos gods must unite and act in concert if their individual plans are to reach fruition, and it is always Tzeentch who brokers these alliances. However, Tzeentch never acts out of altruism, and it can be guaranteed that every time he moves to unite the powers of Chaos he does so ultimately with his own unfathomable goals in mind.

Warp Entities

Alone amongst the Dark Gods, Tzeentch cares little to bring the vessels of Man under his service. The Warp is as much home to these vessels as the material universe, for they must travel through it at great length, and at greater peril, and cunning

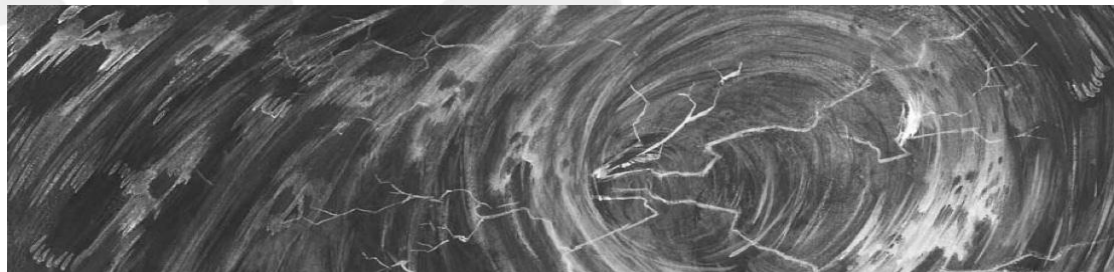

Tzeentch knows that it is here his power lies. Within the Warp exist countless writhing entities, beasts of the Warp, born there or forged there by powers unspeakable. It is Tzeentch's great gambit that in his service these beasts are changed into the forms by which men might know them and fear them most – great, hungry leviathans and all-consuming serpents are the pets of Tzeentch, creatures born from the hellish depth Man has conceived of ever since first his eyes gazed out upon the great oceans of Terra and knew that something truly terrible must lie beneath. That Man's own origins and birth lie also in such murky waters only adds to the instinctive dread and insurmountable fear such monstrousities awaken. When his power is at its greatest, and when his loyal followers offer conduit and sacrifice enough that it might travel beyond the Immaterium, Tzeentch sends such beasts forth into the material universe itself, riding upon the tides of Chaos which surround the warfleets of Chaos, buoyed along by the surging waves of magick and eddies of unreality which Tzeentch's followers bring in their wake. Given form for a time, these leviathans fall upon Tzeentch's enemies like great predators, rending metal, flesh and soul apart with equal ease. The only mercy, perhaps, of such horrors is the inescapable impermanence of such Warp-spawned nightmares.

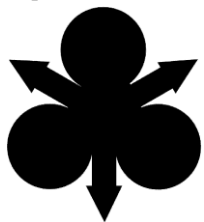

NURGLE

Death is the only constant in the realm of Man, and with death comes decay. Nurgle is the embodiment of disease and deterioration, the elemental forces that hold in check the energies of progress and evolution. There exists within every mortal the desire to let all around him rot, and to exult in the processes of disease and decomposition. Nurgle empowers those who would see every accomplishment of Mankind reduced to mouldering ruin. He is the Lord of Decay, and his servants spread disease and contagion throughout the

mortal realm in the name of their festering master. Yet Nurgle's power embodies, by its very nature, the notion of the eternal cycle of life. Decay is inevitable, but so too is rebirth. The form that rebirth may take is, of course, rarely the ideal and if Nurgle has his way then it will take a form loathsome to Man. Nurgle's appearance is the most abhorrent of the Chaos gods. His bloated body is home to every form of corruption imaginable, and his skin is covered in weeping sores. Foul Nurglings cavort amongst Nurgle's exposed organs, giggling with insane delight at the latest pestilence inflicted upon Mankind by their master. Nurgle's followers suffer under the burden of his 'gifts' as much as they benefit from them. These gifts often take the form of repulsive diseases and hideous deformations which, while useful in spreading Nurgle's contagions, may often lead to the death of the carrier. The servants of Nurgle cry out to him to rid them of the gifts they so blatantly invited when they turned to worship him, and he takes great sport in prolonging their suffering through the granting of yet more of his marks. Nurgle's power within the pantheon of the Chaos gods is inextricably linked to his workings in the mortal realm. When disease and pestilence are rife, then the Lord of Decay's influence is at its height. The very nature of Nurgle's power is such that it will inevitably consume all of its victims and leave few survivors to perpetuate the contagion. At this point the Plague God's might wanes and his plans falter. But one thing is certain: the plague is never truly eradicated, and its spores are often spread far and wide before exploding into yet another epidemic, when once again Nurgle's legions are swelled with



the grotesque living dead.

The only power that can oppose deterioration and decay are those represented by Tzeentch: change and evolution. The two gods are engaged in a galaxy-wide struggle of opposing forces, and whichever wins, the inhabitants of the material realms will be the ones who pay the highest price.

The Plaguefleets of Nurgle

Ships who met their end through disease and decay are the most pleasing sacrifices to Nurgle. Ships are cramped, claustrophobic places at the best of times, and the air which feeds their living crews is a commodity that must be endlessly recycled and filtered back into the vessel. Such lifeless air as this often becomes stale, and the stench of sweat and grime hangs heavy in it. Under this mask of filth, Nurgle and his dedicated followers find little difficulty in spreading something rather more virulent throughout a vessel. Such plagues aboard ships are not uncommon and Nurgle laughs gleefully at such works. A ship's entire crew may ail and weaken beneath this malady, and in such desperation they will turn to Nurgle for protection – and so a plagueship is born, its crew spared the sorrow of death, but instead gifted an eternity beset by the same plague which first laid them low. But decay does not affect merely the living. Nurgle beams all the more proudly to see the creations of Man broken down by decay. The most virulent of his ills do not only strike at flesh, but also bring with them a noxious, stinging acidic feel to the air which can sicken even the metal of a warship. Like the bloated and pocked carcasses of his human followers, Nurgle plagueships bear these scars of disease like a badge of worship – liquified rust running like blood across the hull of his plagueships, cankered and broken power supplies, plasma coils and radiation conduits seeping their magmas like puss while cracked, broken and pulped metals so utterly robbed of their shape as to appear masses of contorted, strangled flesh rise like sores from the once sturdy hull...

SCION OF PROSPERO, THOUSAND SONS BATTLE BARGE 450 Points

When the infant Primarchs were scattered across the galaxy, the child that came to be known as Magnus the Red landed on the world of Prospero. He was fortunate, as normally a grotesque cyclopean being would have been slain at once by superstitious locals. As it was, Prospero was home to an exiled commune of human psykers who saw Magnus as one of their own. Magnus became a ward to the community. He quickly exhibited the psychic traits common to the commune, and by the time he reached physical maturity, his power had grown so much that he surpassed every single person on the planet, possibly the greatest that ever existed other than the Emperor. He believed his intellect could master any discipline and his maxim, above all others, was 'Knowledge is power'.

The Emperor of Man was attracted to the world of Prospero by the psychic beacon that was one of his lost sons. Magnus was granted command of the 15th Space Marine Legion, the naming of the Legion as the Thousand Sons was recognition that only a thousand original Marines were created from Magnus' genetic material. It was a reunion that could not have come at a better time for the Legion. Formed from Magnus' gene-seed, the Legion contained a high number of Marines who had undergone psychic mutation. Very few survived the mutation, of the few who did, many became the greatest psykers of the era, at a time when factions within the Imperium were calling for the extermination of all mutants and psykers. Magnus bent his intellect towards training the Thousand Sons Legion in the way of the psyker.

During this time Prospero gained immeasurable wealth, its capital city of Tizca becoming a beacon of vast pyramidal towers of gleaming silver and gold, becoming a City of Light in the most literal sense. It is during this time that many believe the Thousand Sons passed the point of scholarly pursuit and began to dabble in sorcery. Finally the Emperor himself held a council on the planet Nikaea. The

proposal was made that while the education of psykers to best serve humanity should be made a priority, the conduct of arcane sorcery would be outlawed as an unforgivable heresy. This compromise was made law without a provision for rebuttal, and the Edicts of Nikaea have stood for ten thousand years as official Imperial policy.

The result of the Council of Nikaea served to mask other, darker betrayals, as Warmaster Horus fell to the machinations of Chaos. Magnus foresaw Horus being corrupted by Chaos and the future events of the Horus Heresy. Burdened with the information imparted by this precognitive vision, he first tried to dissuade Horus through the warp and afterward cast spells and used the power of his Legion's greatest sorcerers to convey the news of the impending civil war to the Emperor himself. The Emperor was furious to see that Magnus had broken his oath and was more willing to believe Magnus was the traitor rather than his favored Horus. Leman Russ, Primarch of the Space Wolves Legion, who had always been averse to such witchcraft, was ordered by the Emperor to bring Magnus to Terra to account for his actions, but en-route Russ was convinced by Horus to destroy Magnus's legion rather than let the Emperor forgive Magnus. Accompanying the Space Wolves was a full contingent of his own personal bodyguard and his elite witch-hunting units, the anti-psyker (pariah gene-bearing) Sisters of Silence, originally known as Null Maidens.

Landing in a surprise assault on Prospero, the Space Wolves destroyed Tizca and with it much of the knowledge carefully collected by the Thousand Sons. Magnus appeared defeated, but fate had something else in mind for the cyclopean Primarch. Turning to the power of sorcery once more in order to save himself, his Legion and all the knowledge he had accumulated, Magnus, in his anger at the Emperor and at his brother Primarch crossed over to the side of Chaos in vengeance, he and his Legion becoming the pawns of the Chaos God Tzeentch in

exchange for a mighty work of magic that transported the City of Light into the Eye of Terror. Prospero was destroyed that day, and the next time the betrayed Thousand Sons were seen in combat, they were on the side of Horus. The Thousand Sons retreated to the Eye of Terror after Horus' defeat by the Emperor, after which Tzeentch began bestowing his 'blessings', random physical mutations, on members of the Thousand Sons. A cabal of the legion's strongest sorcerers attempted to counter the warping corruption. Led by Azhek Ahriman, their chief Librarian, they secretly laid the foundations of a mighty spell, afraid that their Primarch would disapprove of their risky actions. The Rubric was both a total success and a total failure. The Thousand Sons were no longer susceptible to mutation, because there was nothing left to mutate. The flesh of the Space Marines was turned to dust, their souls trapped within armor that had become completely sealed. Magnus was enraged, as the Legion he had sacrificed so much for had been destroyed, and he summoned Ahriman to account for his actions. Realizing the Architect of Fate, Tzeentch itself, had orchestrated the entire event, Magnus spared Ahriman.

The Thousand Sons' Chief Librarian was banished on an eternal quest for perfect understanding -- leading him to take up such dangerous and enticing quests as the hunt for the Eldar Black Library. To this end the great sorcerers of the Thousand Sons have used the *Scion of Prospero* as their conveyance either alone or at the head of small flotillas, ranging throughout the galaxy for the better part of ten thousand years. While it is known that Ahriman himself has embarked on this damned warship on several occasions over its long and infamous history, it is not known whether or not he led this ship or was even aboard it at any time during Abbadon's 12th or 13th Black Crusades, though it is known that the ship itself was present during both terrible wars.

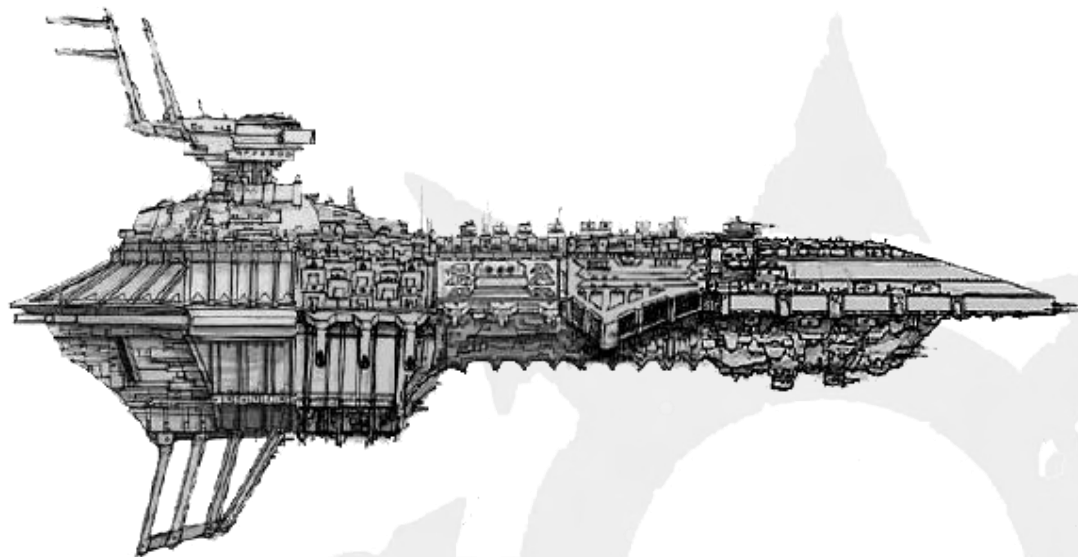

Special Rules: The *Scion of Prospero* is a unique vessel; only one may ever be in a Chaos fleet. It is a ponderous vessel and may not use Come To New Heading special orders. Additionally, it must be used with the following special rules.

Mark of Tzeentch. This ship bears the Mark of Tzeentch as part of its point cost; it does not have to be paid for separately by the ship's commander.

Flagship. If chosen, the *Scion of Prospero* must be used as the fleet's flagship and have its Warmaster placed aboard it unless the Planet Killer is also present, in which case a Chaos Lord must lead it. This vessel may only bear the Mark of Tzeentch. It cannot be used in any fleet that has Death Guard Chaos Space Marines or any vessels bearing the Mark of Nurgle unless the fleet is being led by Abbadon the Despoiler, as there is ageless enmity between the servants of the Bringer of Change and those of the Lord of Decay.

Vortex of Chaos. Favored horrors of Tzeentch writhe and cavort amidst the very bulkheads and girders, and a swirling vortex of Chaos surrounds this vessel. At the end of each movement phase, any ship within 15cm of this vessel (friend or foe!) must place a blast marker in base contact with it.

Vagaries of Fate. The Changer of Ways provides for command of the Fates, affording its auguries snatched glimpses of the future. The ship is gifted with an additional +1 re-roll added to that from the Mark of Tzeentch, but the daemons bound to the hull are easily enraged by a commander's inability to use this foresight and inflict 1Hp damage if this ship's or its Lord's re-rolls fails for any reason.

| TYPE /HITS | SPEED | TURNS | SHIELDS | ARMOR | TURRETS |
|----------------------------|-------|--|--------------------|-------|--------------------|
| Battleship/12 | 20cm | 45° | 4 | 5+ | 4 |
| ARMAMENT | | RANGE | FIREPOWER/STRENGTH | | FIRE ARC |
| Port Weapons Battery | | 45cm | 9 | | Left |
| Starboard Weapon Batteries | | 45cm | 9 | | Right |
| Dorsal Lances | | 45cm | 4 | | Left/ Front /Right |
| Port Launch Bay | | Swiftdeaths: 30cm Doomfires: 20cm Dreadclaws: 30cm | 3 | | N/A |
| Starboard Launch Bay | | Swiftdeaths: 30cm Doomfires: 20cm Dreadclaws: 30cm | 3 | | N/A |
| Prow Launch Bay | | Swiftdeaths: 30cm Doomfires: 20cm Dreadclaws: 30cm | 3 | | N/A |
| Prow Torpedoes | | Speed: 30cm | 6 | | Front |



WAGE OF SIN, EMPEROR'S CHILDREN BATTLE BARGE 430 Points

The Emperor's Children derive from what was once the resource-poor world of Chemos. Dependent on interstellar trade for food and cut off from the rest of the galaxy by ferocious warp storms, strict rationing and improvisation could not prevent the slow death of its people before the arrival of Fulgrim. Named after a long-abandoned god of the people, Fulgrim was beautiful, pale to the point of albinism, with eyes so dark as to be almost entirely pupil and with shimmering white hair, and he soon became a legend in his own right. He quickly grew to understand the technology he had to work with and began to modify it, increasing efficiency dramatically. By the time he was fifteen years of age, Fulgrim became one of the Executives ruling the settlement of Callax. As Chemos continued to deteriorate, Fulgrim decided that he would save his world. Under Fulgrim's leadership, teams of engineers travelled far from their factory-fortress, reclaiming and repairing many of the far-flung mining outposts. As recycling efficiency grew to the point where Chemos was producing a surplus for the first time in years,

Fulgrim began to foster a re-emergence of art and culture, aspects of humanity sacrificed in the struggle for survival. Fifty years after arriving on Chemos, Fulgrim was its sole leader.

When the Emperor first arrived on Chemos, Fulgrim swore fealty to him instantly, and was placed at the head of his Legion. From the Emperor, Fulgrim learned of the distant world of Terra and of the Great Crusade to reclaim the Sundered Galaxy. An accident destroyed the majority of the gene-seed designated for his legion, and without their Primarch, replacing it was a slow and laborious process. Fulgrim came to address the two hundred Space Marines of his Legion, and the words he spoke were said to inspire the Emperor so much that he named the legion the Emperor's Children, allowing them to bear on their power armor the sign of the Aquila, the double-headed eagle that was the Emperor's personal symbol. Fulgrim was anxious to add his contribution to the Great Crusade, but the comparatively small size of his Legion meant that the Emperor's Children

were placed under the command of Horus and his Luna Wolves. Horus and Fulgrim grew close to one another while pacifying the Eastern Fringe. Eagerly continuing his pursuit of perfection, he commissioned his chief apothecary Fabius Bile to tamper with the Legion's gene-seed, enhancing marines like Eidolon far beyond their original abilities but creating monstrous abominations in the process. This pursuit was also applied to the warships of his legion, and the battle barges and cruisers of the Emperor's Children were lavishly appointed, with careful detail applied to every aspect from crew quarters to weapons layout.

When Horus declared that he would no longer follow the Emperor, seven full Legions were sent to challenge the Warmaster. Fulgrim met Horus in person, where Horus was able to sway him to his cause. Fulgrim's respect for Horus allowed Chaos to find its way into Fulgrim's heart, destroying his loyalty to Terra and replacing it with burning desire to destroy the man who held humanity back from the

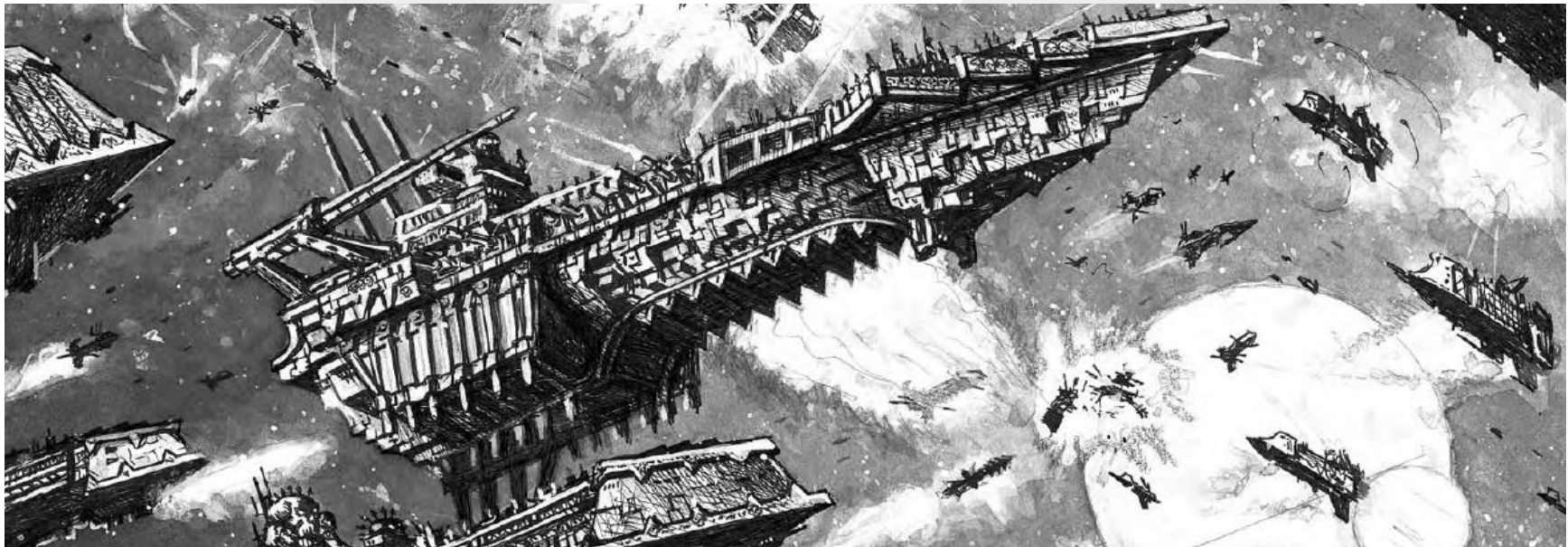

perfection Fulgrim desired. Slaanesh whispered to Fulgrim, and he accepted the promises of his new god. Perfection became perfect hedonism. When the loyalist legions arrived in the Istvaan system, the Emperor's Children were at the forefront of the fighting, aiding in the massacre of their former brethren.

All trace of decency amongst the Emperor's Children had vanished by the time they partook in the Siege of Terra. While other Traitor Legions assaulted the Imperial Palace, the Emperor's

Children embarked upon a spree of terror and gratification amongst the helpless citizenry of Terra. Billions of defenseless civilians were used as experimental subjects in the effort to create ever-more powerful stimulants and pleasure-inducing chemicals, used to summon daemons, raped in countless cases, or were simply tortured and killed to sate the bloodlust of the Legion. When Horus was defeated by the Emperor, the Emperor's Children left a trail of depopulated worlds in their wake as they fled towards the Eye of Terror. As their supply of slaves was exhausted, they resorted to raiding the other Traitor Legions for fresh meat, and in the end were crushed by their angry brethren in a series of bloody wars, culminating in the

disastrous

disastrous Battle of Skalathrax, where the Emperor's Children were shattered into bands of hedonistic fanatics. Despite this, a number of bands have managed to maintain a semblance of structure approaching company strength, and Commander Eidolon in particular still maintains a large retinue of Noise Marines by force of will alone aboard his surviving battlebarge. Codified *Wage of Sin*, it has maintained a close relationship with the Black Legion since the days of the Heresy, and while it has ranged far afield in a never-ending pursuit of more slaves to feed the ravenous appetites of its crew, it has accompanied Abbadon's personal fleet during most of the many Black Crusades he has waged against the Imperium.

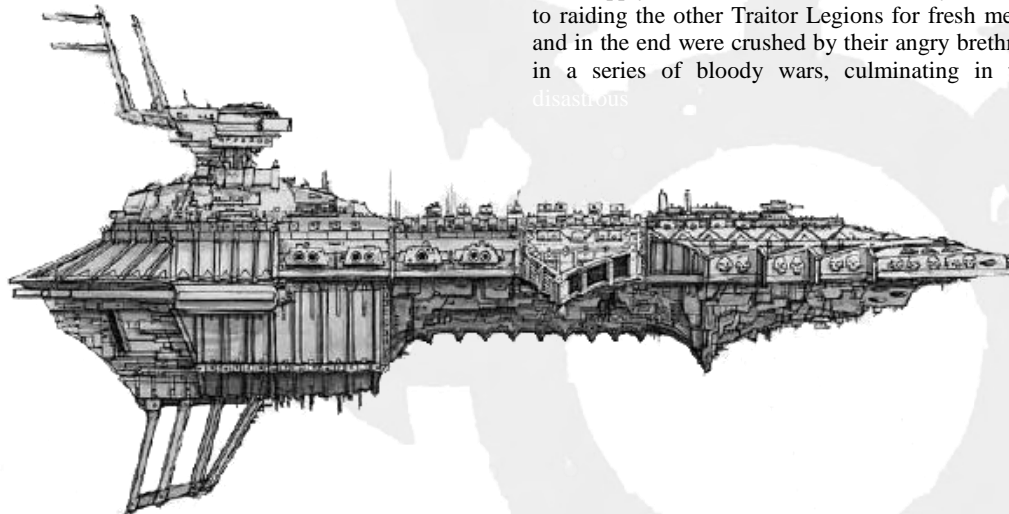

| TYPE /HITS | SPEED | TURNS | SHIELDS | ARMOR | TURRETS |
|-------------------------|-------|--|--------------------|-------|--------------------|
| Battleship/12 | 25cm | 45° | 4 | 5+ | 4 |
| ARMAMENT | | RANGE | FIREPOWER/STRENGTH | | FIRE ARC |
| Port Lances | | 45cm | 4 | | Left |
| Starboard Lances | | 45cm | 4 | | Right |
| Dorsal Weapon Batteries | | 60cm | 6 | | Left/ Front /Right |
| Port Launch Bay | | Swiftdeaths: 30cm Doomfires: 20cm Dreadclaws: 30cm | 3 | | N/A |
| Starboard Launch Bay | | Swiftdeaths: 30cm Doomfires: 20cm Dreadclaws: 30cm | 3 | | N/A |
| Prow Torpedoes | | Speed: 30cm | 9 | | Front |

Special Rules: The *Wage Of Sin* is a unique vessel; only one may ever be in a Chaos fleet. It is a ponderous vessel and may not use Come To New Heading special orders. Additionally, it must be used with the following special rules.

Mark of Slaanesh. This ship bears the Mark of Slaanesh as part of its point cost; it does not have to be paid for separately by the ship's commander.

Flagship: If chosen, the *Wage Of Sin* must be used as the fleet's flagship and have its Warmaster placed aboard it unless the Planet Killer is also present, in which case a Chaos Lord must lead it. This vessel may only bear the Mark of Slaanesh. It cannot be used in any fleet that has World Eaters Chaos Space Marines or any vessels bearing the Mark of Khorne unless the fleet is being led by Abbadon the Despoiler, as there is remains unforgivable animosity between the World Eaters and the Emperor's Children dating from the Battle of Skalathrax.

Palace of Pleasure. The glittering domes and spires of this ancient vessel are dedicated to every perverse and extreme form of stimulation imaginable, and a retinue of Noise Marines have made it their permanent conveyance. This ship always counts as being crewed by Emperor's Children Chaos Space Marines (included it its cost), following the rules on p.45 of Armada.

TERMINUS EST, DEATH GUARD BATTLE BARGE 430 Points

The *Terminus Est* was one of the first capital ships assigned to the Death Guard by the Emperor. It was of a unique design that pre-dated the Great Crusade and which was copied in M36 as part of the Gareox Prerogative to create the Despoiler class. As might be expected the older vessel was considerably more powerful than the later copy. Nothing definite is known of the pre-Heresy configuration of *Terminus Est*. References exist that suggest it was primarily employed as a planetary assault ship. This is not unusual as it conforms with the role assigned to the vessels of the Space Marine Legions. Many of the vessels used in the Great Crusade were, however, handicapped by system failures that the Imperium lacked the ability to repair. Often this would result in many systems being replaced with less efficient but more easily maintained alternatives. The role of *Terminus Est* during the Heresy is better known. At Istvann the *Terminus Est* engaged and destroyed *Shadow of the Emperor*, the flagship of the Raven Guard. It is argued that this engagement was the earliest recorded conflict between battleships specialised to carry attack craft. The engagement was swift and deprived the embattled loyalist forces of any air support in the massacre that followed.

When *Terminus Est* was sighted as part of the armada that followed Horus to Terra it had changed. The Mark of Nurgle was upon it and all the other vessels of the Death Guard. When Mortarion led the assault on the Lion Gate starport Typhus controlled the Plaguefleet and it is suspected actually began the orbital bombardment of the Emperor's Palace. Following Horus' death and the arrival of loyalist reinforcements the *Terminus Est's* formidable reserves of attack craft were expended as a rearguard while the Death Guard were evacuated back to their ships. Along with the rest of the Traitor Legions the Death Guard fled to the Eye of Terror and disappeared from Human knowledge for centuries. In the Eye it is suspected that the Traitor Legions fought amongst themselves. It is the boast of the Death Guard that their Primarch-turned-Daemon

Prince Mortarion conquered a mighty empire within the Eye and transformed it to his own tastes.

Typhus and the *Terminus Est* were among the first of the Death Guard to be sighted again when they brought plague to the Agripinaa system in M35. The success of the *Terminus Est* in defeating the battlegroups sent against it had a major effect on the thinking of the Imperial Navy. In M36 an Adeptus Mechanicus expeditionary force succeeded in finding schematics of its design on the perditia world of Barabus and began building the Despoiler class. Little were they to now that the core architecture and design of the class' warp shields hid a fundamental flaw. Only when in the following centuries the vessels of this class were either lost in the Warp or

turned renegade did the realization strike home. The *Terminus Est* and Typhus did not assume a central role in the Gothic War. A single sighting near Anvil 206 was the only evidence of their presence. However, considering the later incidents traced back to Anvil 206 it is clear that a particular mission was accomplished. In M41 the *Terminus Est* is one of the oldest ships known to the Imperium, the power of Nurgle holding its ancient hull together while the most virulent plagues seethe through its dank corridors. The *Terminus Est* is a part of Nurgle's realm given license to travel the stars, spreading death at the behest of its damned captain. There will be no rest for the Imperial Navy until it is finally hunted down and cleansed forever.



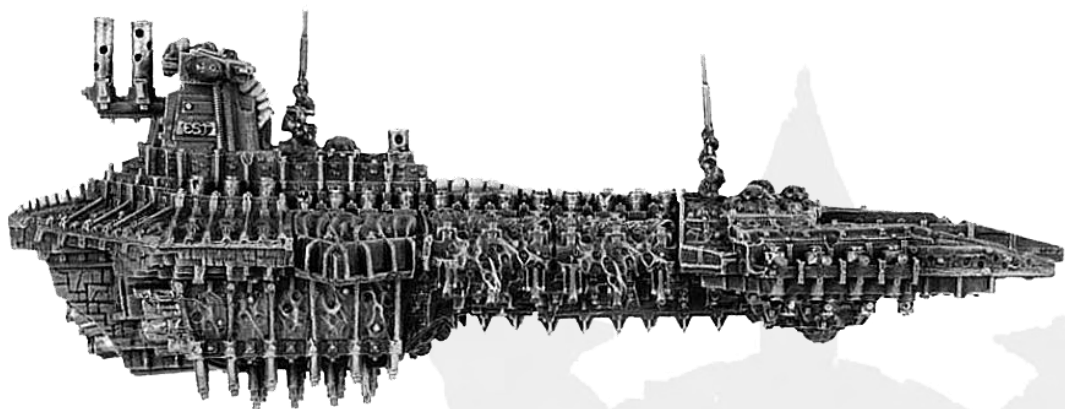

| TYPE /HITS | SPEED | TURNS | SHIELDS | ARMOR | TURRETS |
|---------------------------|-------|--|--------------------|-------|--------------------|
| Battleship/13 | 20cm | 45° | 4 | 5+ | 4 |
| ARMAMENT | | RANGE | FIREPOWER/STRENGTH | | FIRE ARC |
| Port Hives of Nurgle | | 30cm | 6 | | Left |
| Starboard Hives of Nurgle | | 30cm | 6 | | Right |
| Dorsal Lances | | 45cm | 4 | | Left/ Front /Right |
| Port Launch Bay | | Swiftdeaths: 30cm Doomfires: 20cm Dreadclaws: 30cm | 3 | | N/A |
| Starboard Launch Bay | | Swiftdeaths: 30cm Doomfires: 20cm Dreadclaws: 30cm | 3 | | N/A |
| Prow Launch Bay | | Swiftdeaths: 30cm Doomfires: 20cm Dreadclaws: 30cm | 3 | | N/A |
| Prow Lances | | 30cm | 4 | | Left/ Front /Right |



Special Rules: The *Terminus Est* is a unique vessel; only one may ever be in a Chaos fleet. It is a ponderous vessel and may not use Come To New Heading special orders.

Mark of Nurgle. *Terminus Est* cannot be boarded. The extra hit and point cost are already included in its profile and point cost and does not have to be paid for separately by the ship's commander.

Flagship: If chosen, the *Terminus Est* must be used as the fleet's flagship and have its Warmaster placed aboard it unless the Planet Killer is also present, in which case a Chaos Lord must lead it. This vessel may only bear the Mark of Nurgle. It cannot be used with any fleet that has Thousand Sons Chaos Space Marines or vessels bearing the Mark of Tzeentch unless the fleet is being led by Abbadon the Despoiler, as there is ageless enmity between the servants of the Bringer of Change and those of the Lord of Decay.

Miasma of Pestilence. The *Terminus Est* is surrounded by vast swarming clouds of the same Warp-spawned flies which buzz and howl through its interior and first transformed Typhus into the Host of the Destroyer Hive. This miasma permeates outwards from the ship through blisters, boils and fractures in its surface or through corroded discharge tubes and weapon barrels. It replaces the ship's turrets and works in exactly the same way as turrets against attack craft but has no effect against torpedoes.

Hives of Nurgle. Along either side of the *Terminus Est*, row upon row of pustules, hives, and sores fester upon the ship's cankered hull. These growths cover the rusted remains of what was once the ship's main broadside batteries like coral over rock, periodically erupting violently and hurling a mixture of corroded debris, ammunition and filth out into space. The Hives of Nurgle function in exactly the same way as weapons batteries. The Nurgle player may also place a single Blast marker anywhere along the *Terminus Est*'s course after each move to represent the constant seeping from these hives. The miasma obscures and distorts the shape of the *Terminus Est*, meaning that vessels within 15cm do not benefit from a left column shift when firing at it.

VENGEFUL SPIRIT, BLACK LEGION BATTLE BARGE 410 Points

Horus, one of the twenty gene-children of the Emperor, is believed by some to have been the first Primarch rediscovered after they were scattered across the galaxy. Horus was found on the planet of Cthonia, a world close enough to Holy Terra that it was within reasonable reach of non-FTL spacecraft. For thirty years, Horus was the only Primarch-son of the Emperor, and during this time they, together with the Sixteenth Space Marine Legion, known as the Luna Wolves, began the Great Crusade and forged the initial expansion of the Imperium of Man. In these days of the Great Crusade when the Emperor of Mankind still walked among mankind, vast legions of Space Marines sallied forth to take possession of the galaxy, subduing all that stood before them and exterminating any alien Xenos encountered to make way for his divine Manifest Destiny. The Emperor and his first Primarch saved each other's lives on several occasions, and it was said that there was a great affinity between them. In these heady days all of mankind stood united, and with their fealty sworn fully to the Emperor as their Ommissiah, many wondrous and terrible creations did the Adeptus Mechanicus construct to carry forth his edict. Among these vessels was a new kind of warship, one of unbelievably vast dimensions equipped with all the firepower of a battleship but capable of transporting and delivering vast numbers of men and materiel directly to the battlefield. This new type of ship served as the chariots that carried forth the Emperor and his Primarchs to conquer the galaxy. Designated a Battle Barge, no other ship type came to be as feared and respected as these, and just their arrival would often result in the quick surrender of a contested system.

When the Emperor divined the presence of the second Primarch, he left Horus in full command of the Great Crusade. As more Primarchs were discovered and reunited with their Legions of Space Marines, Horus was often granted overall strategic command. Horus relished this position as head of his legion and its attendant 63rd Expeditionary Fleet

consisting of several battle barges making up the spearpoint of many hundreds of warships and attendant vessels. He proved his skill time and time again while winning the respect of the Emperor and the admiration of the other Legions. The Luna Wolves Legion reveled in the glory of being the personal guard of the greatest Primarch, sharing Horus' belief in fighting to be the best. The Luna Wolves were always at the forefront of the campaigns, striving to conquer more than any other force in the Imperium. Often, the Legion would swoop in, smash the centers of resistance, and move on, leaving other forces to secure the planet and provide garrison forces. Considered to be the greatest campaign of the Great Crusade, the Luna Wolves' defeat of a massive Ork empire resulted in many awards heaped on the Legion by the Emperor, most notably the promotion of Horus himself to the rank of Warmaster, supreme commander of the Luna Wolves and the Emperor's Armies. It was at this time the Emperor also suggested the Luna Wolves be renamed to the Sons of Horus, though this did not occur until about three years later. The wording of the Emperor's proclamation, claiming the glory of Horus' victories on Ullanor as his own, was the usual rhetoric for such announcements, but it seemed to awaken a deep seated resentment in Horus. In the Primarch's eyes, the Emperor spent his time safe in his palace on Terra, where he returned after the Ullanor Crusade, while Horus created his Imperium for him.

Horus was wounded on the moon of the world of Davin by Eugean Temba, a former Imperial Army Lord Commander who had been left behind to govern Davin after the Luna Wolves' conquest but had been corrupted by the Chaos God Nurgle. Temba used an alien sword infused with Chaos energies to badly wound Horus. When his apothecaries were unable to treat Horus' Chaos-infested wounds, he was taken by Erebus of the Word Bearers and the Mournival, high-ranking members of the Sons of Horus, to the lodge on Davin to be healed. It was during this time that

Horus was first corrupted by Chaos, and it was then that Magnus the Red first recognized the threat to the Imperium and attempted to intercede. Not believing Horus would betray him, the Emperor rebuked Magnus for his effort, setting the stage for the Horus Heresy and the unimaginable atrocities that followed.

The Sons of Horus took part in many of the campaigns of the Horus Heresy, from the betrayal at Istvaan V right through to the Siege of the Emperor's Palace. It was in the all-consuming fires of the Horus Heresy that battle barges proved themselves as both the bane and savior of Mankind. Countless worlds were reduced to rubble and seas of radioactive glass under the withering fire of its many rows of weapon batteries, and countless of these vessels were lost defending loyal worlds against the vile host of the Betrayer's warfleets. In fact, it was aboard the *vengeful Spirit*, flagship of Primarch Horus that the final climactic battle of wills took place between the Emperor and his chosen Warmaster turned foul traitor. Though the Emperor was mortally wounded, the traitor Horus was slain, and this one act spelled defeat for the forces of Chaos as the Battle for Terra was won.

Nearly all of these titanic ships were lost or destroyed during and immediately after the Horus Heresy and subsequent reorganization of the remaining loyal Space Marine legions into the many Chapters that have thereafter existed for millennia. Few of these vessels are still confirmed to exist, such as the *Harbinger of Doom* of the Black Legion and the *Stonebreaker* of the Iron Warriors, though others may still ply the unassailable reaches of the Maelstrom and Eye of Terror. Though exceedingly rare, these vessels still rightfully command deep respect and fear. Persistent rumors abound that the *Stonebreaker* has recently taken part in overrunning a remote but critically important Adeptus Mechanicus facility, but this has been categorically denied by Imperial authorities.

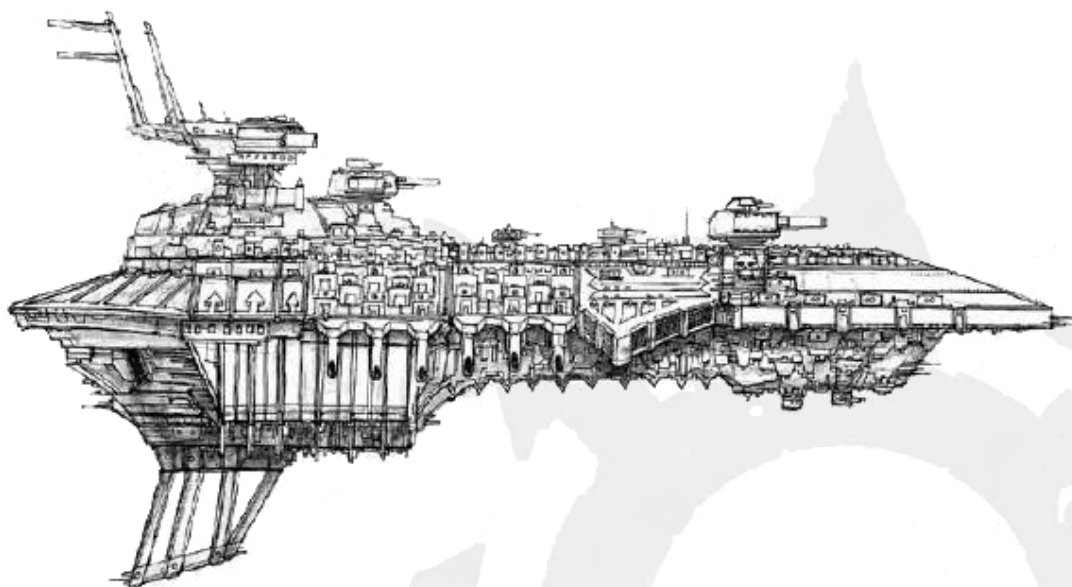

FAMOUS BATTLE BARGES:

Harbinger of Doom (Black Legion)
Destiny's Hand (Word Bearers)
Longinus (Emperor's Children)

Umbra Insidior (Night Lords)
Stonebreaker (Iron Warriors)
The Alpha (Alpha Legion)

| TYPE /HITS | SPEED | TURNS | SHIELDS | ARMOR | TURRETS |
|----------------------------|-------|--|--------------------|--------------------|---------|
| Battleship/12 | 20cm | 45° | 4 | 5+ | 4 |
| ARMAMENT | | RANGE | FIREPOWER/STRENGTH | FIRE ARC | |
| Port Weapons Battery | | 60cm | 6 | Left | |
| Starboard Weapon Batteries | | 60cm | 6 | Right | |
| Dorsal Lances | | 60cm | 3 | Left/ Front /Right | |
| Port Launch Bay | | Swiftdeaths: 30cm Doomfires: 20cm Dreadclaws: 30cm | 3 | N/A | |
| Starboard Launch Bay | | Swiftdeaths: 30cm Doomfires: 20cm Dreadclaws: 30cm | 3 | N/A | |
| Prow Launch Bay | | Swiftdeaths: 30cm Doomfires: 20cm Dreadclaws: 30cm | 2 | N/A | |
| Prow Lances | | 30cm | 4 | Front | |

Special Rules: As the flagship battlebarge of Warmaster Horus, the *Vengeful Spirit* was effectively the capital ship of the entire Great Crusade, and its design was widely emulated in several variants by the Mechanicus Adepts of Mars before the Heresy. What remain of these rare vessels may have changed hands and crews in the intervening millennia. Chaos battlebarges can be led by a Chaos Lord having +1 leadership for +25 points, and may also embark Chaos Space Marines for an additional +1 leadership (max 10) for +35 points. If Chaos Space Marines are taken, it may embark Chosen Terminators for +10 points, allowing it to roll 2D6 and pick the highest D6 when conducting a Hit and Run attack. Chaos Space Marine battlebarges are ponderous vessels and cannot use Come To New Heading special orders.

Chaos Battlebarge Variants: While the *Vengeful Spirit* was representative of the battlebarges used by nearly all of the Space Marine Legions at the time of the Horus Heresy, a number of Primarchs, and even renowned Battle-Captains ordered subtle modifications to their ships under their command during extended stays in port between times at the spear tip of the Great Crusade. For no change in cost, these Chaos battle barges may exchange their broadside weapon batteries for range-45cm, firepower-8, or range-30cm, firepower-10. They may also exchange their prow lances for 8 torpedo tubes for +10 points, and/or their dorsal lances for range-45cm, strength-4 for +10 points.

Loyalist Venerable Battlebarge: Most of the Space Marine battlebarges dating from the Great Crusade were destroyed during the Horus Heresy or in the intervening millennia. However, a small number of the battle barges and other truly ancient vessels from that distant age still remain as venerated icons harking to a time when the Emperor himself still walked among his subjects, particularly among Chapters dating from the First and Second Founding. A loyalist Space Marine Chapter may include a single Chaos battle barge in its fleet as its Venerated Battle barge for the listed point cost and using the basic profile, painted appropriately and adding +35 points for having a Space Marine crew.

CONQUEROR, WORLD EATERS BATTLE BARGE 380 Points

As a boy, Angron was found by a slaver who recognized he had great promise and had him implanted with bio-neural circuitry used to increase a warrior's aggression and strength. Angron was then inducted into the ranks of the planet's numerous slave-gladiators. After only a few months in the largest arena of the planet's capital, Angron came to be known as a proud warrior of fearsome skill, and quickly became a crowd favorite. He killed hundreds of gladiators, in both single and multiple combats, but spared those who had fought well.

Angron trained several of the gladiators he had spared, and at the height of the largest gladiatorial event on the planet, Angron and his followers turned on the crowd, slaughtering everyone and fighting their way free in a display of psychotic, implant-augmented fury. They prepared themselves for the final battle as five vastly superior armies surrounded the slaves' camp. It was at this time that the Emperor revealed himself. Angron was offered leadership of but Angron refused, believing his place to be with the army he forged and led. The Emperor teleported him to his own ship against Angron's wishes, abandoning his troops to certain defeat and death. Angron eventually took command of the World Eaters, but never forgave the Emperor for his abduction, and what he saw as a betrayal of martial

honor. This bred resentment that eventually contributed to Angron's joining the Traitor Marines' rebellion against the Emperor that was led by the Warmaster Horus.

Knowing firsthand how effective the surgery inflicted on him could be, Angron ordered the Legion's Techmarines to replicate the implants and processes, using himself as a template. Soon the entire Legion was modified, and initially the enhanced Companies of the World Eaters were highly successful, gaining a reputation as effective terror troops. The shipyards at his disposal did not hesitate to incorporate refits that optimized the vessel for the combat doctrine and fighting style of his Legion, favoring high speed and serrated ranks of close-ranged batteries that encouraged close-quarters battles over the spearhead formations and ranged combat doctrines developed over the course of the Great Crusade. No mercy was offered by the World Eaters, only bloody death at the end of a chain-axe, and entire systems would surrender unconditionally in attempts to avoid suffering this fate shortly after his flagship arrived. Eventually, the Legion's use of implants was discovered, and the Emperor ordered Angron to cease modifying his soldiers. Unsurprisingly, Angron disobeyed, ordering his Techmarines to continue the surgeries in secret.

Capitalizing on the Legion's ranks of raving warriors and bloody rituals, it took little effort for them to be corrupted into the worship of Khorne, and they were the first to side with Horus when his betrayal was made public. As part of a bloody sacrifice to their new master, the Librarians of the World Eaters were hunted down and killed by their brother Marines, as Khorne despised all practitioners of the sorcerous (psyker) arts.

After Horus's defeat and their retreat to the Eye of Terror, Angron was elevated to daemonhood, becoming Khorne's greatest daemon prince. For centuries the fate of the *Conqueror* remained a mystery, though scattered reports indicate it was at the head of small flotillas or solitary raids on several occasions throughout Segmentum Obscurus and the Northern Rim. When the World Eaters ceased to exist as a unified Legion due to the actions of Khârn the Betrayer during the Battle of Skalathrax in 021.M31, the *Conqueror* likewise faded to obscurity. It was finally reported destroyed by a large Imperial formation in M35, but this proved to be incorrect when it again assailed itself upon the Dominion of Man in a series of raids in 435.M37 ranging throughout Segmentum Obscurus. Adorned with row upon row of white, leering skulls in dedication to the throne of Khorne, it is known to have changed hands



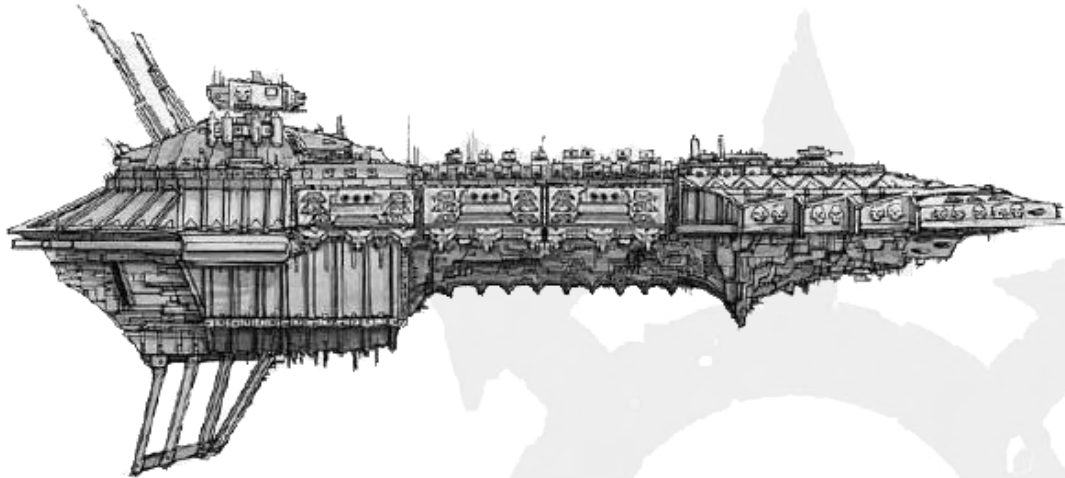

several times, as the servants of the blood god see their starships as little more than a means of transport from one opportunity to slaughter for Khorne to the next.

The *Conqueror* figured prominently during the Accursed One's 12th Black Crusade in the Gothic Sector, this time under the leadership of Warmaster Heinrich Bale at the head of a large fleet of ships. His warfleet in general and his flagship in particular proved to be a menacing foe that successfully maintained a blockade of Port Maw itself for more than three years and laid waste to many Imperial ships in the Port Maw sub-sector. His was one of the very last warfleets to withdraw in defeat in the closing stages of the Gothic War, only doing so while engaging in a titanic series of running battles during which many of the ships under his command were destroyed, usually only after engaging at close range and attempting to board their enemies rather than retreat. Once again the infamous vessel escaped and disappeared from the record, only to emerge at the head of a small warfleet during the 13th Black Crusade, this time as the flagship of Kosolax the Foresworn.

| TYPE /HITS | SPEED | TURNS | SHIELDS | ARMOR | TURRETS |
|----------------------------|-------|-------------|--------------------|-------|--------------------|
| Battleship/12 | 25cm | 45° | 4 | 5+ | 4 |
| ARMAMENT | | RANGE | FIREPOWER/STRENGTH | | FIRE ARC |
| Port Lances | | 30cm | 3 | | Left |
| Starboard Lances | | 30cm | 3 | | Right |
| Dorsal Weapon Batteries | | 45cm | 8 | | Left/ Front /Right |
| Port Weapon Batteries | | 30cm | 12 | | Left |
| Starboard Weapon Batteries | | 30cm | 12 | | Right |
| Prow Torpedoes | | Speed: 30cm | 9 | | Front |

Special Rules: The *Conqueror* is a unique vessel; only one may ever be in a Chaos fleet. It is a ponderous vessel and may not use Come To New Heading special orders. Additionally, it must be used with the following special rules.

Mark of Khorne. This ship bears the Mark of Khorne as part of its point cost; it does not have to be paid for separately by the ship's commander. If it is not the flagship, a Chaos Lord must lead it.

Bezerker Horde. As part of its cost, it embarks Chaos Space Marines with the Mark of Khorne, following all rules for Chaos Space Marines on p.45 of Armada. It embarks a retinue of Khorne Bezerkers, giving it a boarding modifier of +2 in addition to its improved boarding value. It is embarked with Chosen Terminators and may roll 2D6 and pick the highest D6 when conducting a teleport Hit and Run attack each turn.

Chariot of Slaughter: This vessel may only bear the Mark of Khorne. If chosen, it does not have to be used as the fleet's flagship unless it is the most expensive vessel present. It cannot be used in any fleet that has Emperor's Children Chaos Space Marines or any vessels bearing the Mark of Slannesh unless the fleet is being led by Abbadon the Despoiler, as there remains unforgivable enmity between the World Eaters and the Emperor's Children.

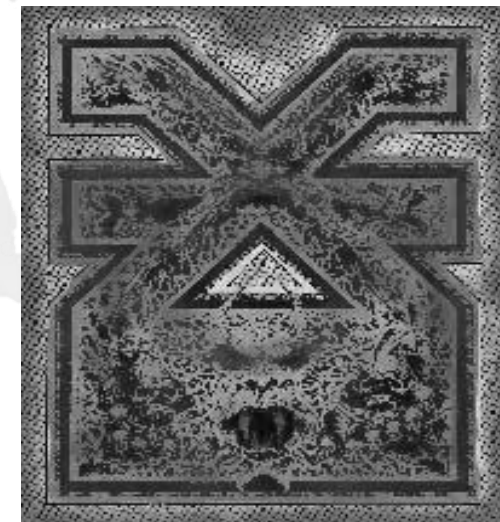

CHAOS HECATE CLASS HEAVY CRUISER 230 Points

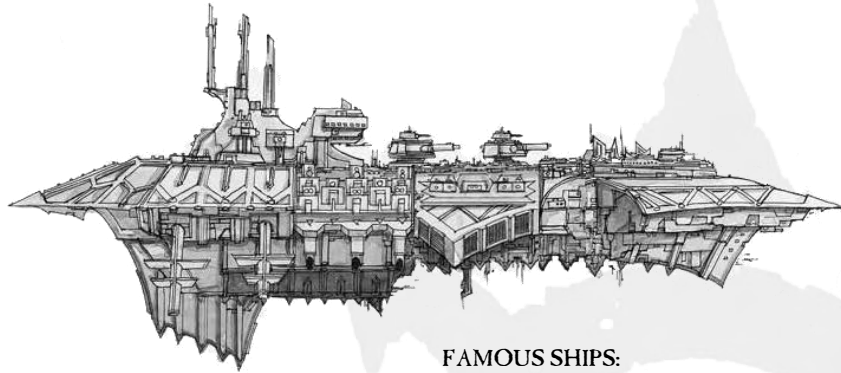

FAMOUS SHIPS:
Blade of Fury *Erebus* *Reign of Terror* *Lustful*

As the Styx began to fall out of favor late in M33, the Hecate was seen as a more fitting and well-rounded replacement for fleet engagements and solitary patrols. The shipyards at Cypra Mundi were only beginning to construct these in any quantity when newer hull designs by the shipyards of Mars were deemed more suitable for the Imperial Navy. Most were decommissioned by late M35, though the *Blade of Fury* was used in fleet exercises as part of the Gaerox Prerogative as late as M36. By this time a number of similar vessels had turned renegade, and fearing some inherent design flaw that made these ships susceptible to corruption, the Imperial Navy fleetlords at Cypra Mundi acted swiftly to decommission the remainder of these ships in favor of the new Mars-type hull design.

Only one of these vessels was known to have turned renegade before the Gothic War, though it is unknown with any certainty if it was present during that conflict. However, at least three of these ships were captured very early during Abbadon's 13th Black Crusade, including the *Blade of Fury*, *Erebus* and *Admiral Foster*. The *Blade of Fury* was subsequently seen accompanying the traitor battle barge *Wage of Sin* on several occasions, particularly during the razing of Belisimar and for several raids on the orbital docks of Belis Corona. The *Admiral Foster* was most active of the four. Renamed *Reign of Terror* by its captain, it participated in numerous engagements at Ormantep and Thracian Primaris and was among the fleet present at the destruction of Urthwart by the mighty *Planet Killer*.

| TYPE /HITS | SPEED | TURNS | SHIELDS | ARMOR | TURRETS |
|----------------------------|--|-------|--------------------|--------------------|---------|
| Cruiser/8 | 25cm | 45° | 2 | 5+ | 3 |
| ARMAMENT | | RANGE | FIREPOWER/STRENGTH | FIRE ARC | |
| Port Launch Bay | Swiftdeaths: 30cm Doomfires: 20cm Dreadclaws: 30cm | | 2 | N/A | |
| Starboard Launch Bay | Swiftdeaths: 30cm Doomfires: 20cm Dreadclaws: 30cm | | 2 | N/A | |
| Dorsal Lance Batteries | 60cm | | 2 | Left/ Front /Right | |
| Port Weapon Batteries | 45cm | | 4 | Left | |
| Starboard Weapon Batteries | 45cm | | 4 | Right | |
| Prow Weapon Batteries | 45cm | | 6 | Left/ Front /Right | |

“Since before the time of The Fall, our race has been haunted by what we, in our reckless pursuit of hedonistic indulgence, gave birth to. Though our dreams once overturned worlds and quenched suns, we are now but fitful shadows clinging to the edge of existence. All the stars in the sky cannot blot out the hateful glare of the Red Moon’s Eye. The birthing place of the Great Enemy pulses with all the malice of a daemon that is dreaming, casting its shadow over all we have ever done and all we ever shall. Every twisted strand of Fate and casting of the Runes leads me to this time, to this place, and it is clear that the final battle awaits me at the ancient Crone Worlds. A conflict the likes of which has not been seen since the Mon-Keigh warred amongst themselves, when their corpse of a seer fell to his traitorous son, is coming and all my steps lead towards it, no matter that I walk other paths. I see the stars stained red with blood of the Mon-Keigh and, though their wars do not concern me and I would gladly let them destroy one another, I know that to avoid this fight is to condemn my race to inevitable doom. And though all I see is darkness, I know that I will not flinch from my destiny.”

- Eldrad Ulthran, Farseer of the Ulthwé Craftworld
before his death attempting liberate the Blackstone Fortress above Cadia

CHAOS INFERNO CLASS CRUISER. 180 Points

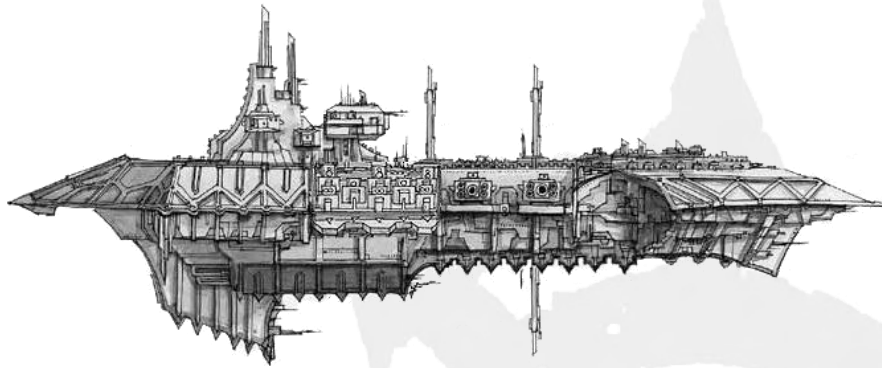

FAMOUS SHIPS:

Havoc Pillager Apostate Rampage
Cerberus Tartarus Emasculator

The Inferno is believed to be an early design and a later counterpart of the Carnage. However, it was marred by technical difficulties and not entirely successful in overcoming many of the shortcomings experienced by the Carnage in maintaining and powering its long-range batteries. The Inferno was quickly supplanted in front line units by more modern types. Even the Bastion fleets have not had an example of this class for many centuries, though several were known to be maintained by the Adeptus Mechanicus as experimental platforms and other such uses. A small number were known to turn renegade before the class was entirely removed from service by M35. None were known for certain to have been present during the Gothic War, though the *Havoc* and *Cerberus* are both known to have operated throughout Segmentum Obscuras and the Northern Rim. The *Pillager* and *Rampage* on the other hand have spent little time in Segmentum Obscuras since going renegade, and for many centuries their whereabouts were unknown until scattered reports concerning these two vessels surfaced in the vicinity of the Maelstrom in M37.

Several vessels of this class were reported in various engagements at Cadia, Kantrael and Agripinaa. While only the *Pillager* was identified with any certainty, at least two or three of these ships must have participated in the war for the vast distances between systems they were sighted in.

| TYPE /HITS | SPEED | TURNS | SHIELDS | ARMOR | TURRETS |
|----------------------------|-------|-------|--------------------|-------|--------------------|
| Cruiser/8 | 25cm | 45° | 2 | 5+ | 2 |
| ARMANENT | | RANGE | FIREPOWER/STRENGTH | | FIRE ARC |
| Port Lance Batteries | | 45cm | 2 | | Left |
| Starboard Lance Batteries | | 45cm | 2 | | Right |
| Port Weapon Batteries | | 45cm | 4 | | Left |
| Starboard Weapon Batteries | | 45cm | 4 | | Right |
| Prow Weapon Batteries | | 60cm | 6 | | Left/ Front/ Right |

Using the Forces of Chaos: The Forces of Chaos special rules described in the Mark-specific fleet lists can be used as described by any vessel used with that fleet list (including the flagship) unless specifically stated otherwise, but they can not be used by ships (even battle barges) taken as reserves in other Chaos fleets. In all respects they may be used in conjunction with the Forces of Chaos listed on p.158 of the Battlefleet Gothic Rulebook earned normally in a campaign.

Using Vessels for the Power of Chaos: Battle barges listed in their special rules as unique vessels can only be taken once in any Chaos fleet. Those described as flagships can *only* be used in this manner unless the Planet Killer is also present, which can be taken in any Chaos Powers fleet. Vessels that must carry Marks contrary to each other (such as the Mark of Nurgle and the Mark of Tzeentch) cannot be used at the same time unless Abaddon the Despoiler is leading the fleet. Following these and all normal restrictions, any battlebarge can be taken as reserves of another Chaos fleet. The *Vengeful Spirit* and its variants can be taken in any Chaos fleet for the point costs indicated in the same manner as battleships but otherwise without restriction. Hecate and Inferno class vessels can be taken in the same manner as other heavy cruisers and cruisers in any Chaos fleet list.

Using Renegade Imperial Vessels: In the ten millennia since the Horus Heresy, countless warship crews have mutinied against their officers or colluded with them to renounce their vows to the Imperium and turn renegade, especially during the Gothic War and the 13th Black Crusade. While some classes have proven more prone to this taint than others, few ship classes has proven entirely immune to the allure of Chaos or the promise of easy wealth and power. From any Imperial Navy fleet list, one cruiser up to 185 points and/or up to six Imperial Navy escorts may be taken for every 1,500 points in a Chaos fleet. Weapon refits, Nova Cannon, Chaos Lords, Chaos Space Marines, Chaos ordnance or Daemonship upgrades may not be taken for Imperial Navy vessels used in this manner, and cruisers suffer -1Ld for going renegade. Imperial Navy escorts need not be in a single squadron and may be interspersed within other Chaos escort squadrons if desired. These vessels do not count as reserves; they count as Chaos vessels in all respects.

ACTIVATED BLACKSTONE FORTRESS 750 Points

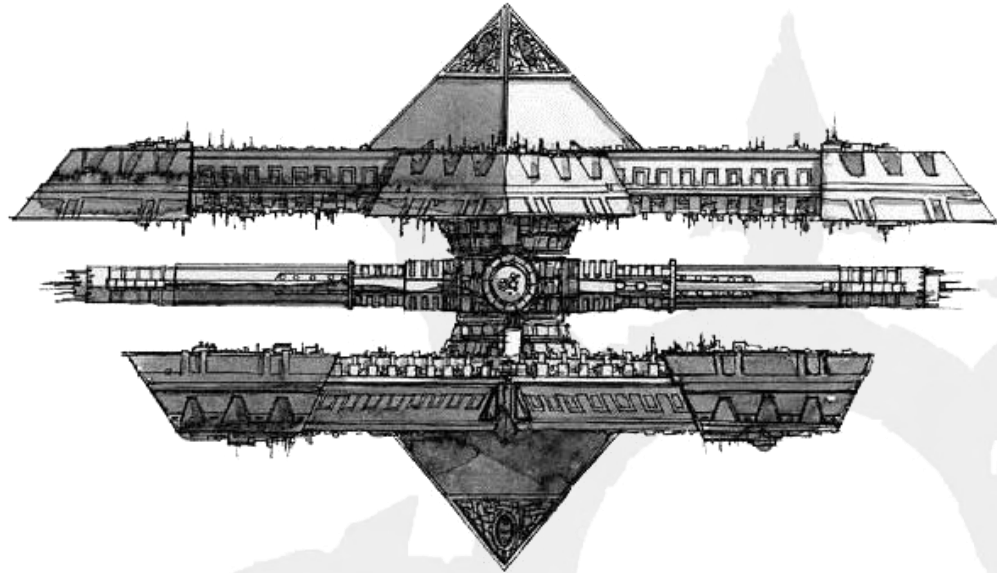

It is an unspeakable irony that much of what is known about the Blackstone Fortresses was only ascertained after they were lost to the Imperium during the Gothic War. Now believed to be millions of years old, they were originally known by the ancient Eldar as the *Talismans of Vault*. The Fortresses were equipped with a warp-cannon that could create a devastating rip in space and an eruption of energy out of the Immaterium. Long dormant, they were easily boarded, claimed by the military forces of the Imperium of Man, modified and integrated into the defense infrastructure of their star systems. However, during the Gothic War, Abaddon the Despoiler came into possession of ancient artifacts known as the Eye of Darkness and the Hand of Night, which he somehow used to activate and control three of these behemoth constructs. Once awake they were able to shed their grafted-on Imperial equipment and glide slowly through space under their own power, using their original warp-cannon in place of the turrets and fighter bays the Navy had built onto them. Each was capable of destroying worlds, and the three together proved capable of destroying an entire star system, causing the star Tarantis to go nova. At the end of the Gothic War, a combined force of Imperial Navy and Eldar forces destroyed one of the three in Abaddon's possession, at which time the remaining three still in Imperial hands self-destructed as well.

For centuries, there was no sign of the two Blackstone Fortresses Abaddon managed to escape with back to the Eye of Terror. That all changed at the beginning of the 13th Black Crusade, when the Accursed One used them to great effectiveness to batter the planet of Cadia, holding the entire system in thrall until once again a combined fleet of Imperial and Eldar warships forced it and its escorts to withdraw. There are reports that the second remaining Blackstone Fortress was destroyed during a surprise attack by Necron raiders, but this has not been confirmed.

Note: Only one Activated Blackstone Fortress may be fielded for every FULL 750 points of other ships in a Chaos fleet. No more than three may be taken.

| TYPE /HITS | SPEED | TURNS | SHIELDS | ARMOR | TURRETS |
|--------------|-------|---------|--------------------|-------|------------|
| Defense/16 | 10cm | Special | 6 | 6+ | 0 |
| ARMAMENT | | RANGE | FIREPOWER/STRENGTH | | FIRE ARC |
| Warp Cannons | | 90cm | 8 | | All Around |

Special Rules: A Blackstone Fortress cannot go onto special orders but is assumed to automatically pass all other Leadership tests it is required to make. The Blackstone Fortress can move up to 10cm in any direction in the movement phase; it does not turn like a normal ship. It has no crew and so does not add a D6 to its boarding score during a boarding action. A Blackstone Fortress' warp cannons roll 1 dice per point of Strength and require a 4+ to hit, like a lance. However, a warp cannon shot ignores shields: all hits will affect a ship directly.

Super Mega-Death Shot: The Blackstone Fortress is capable of channeling its energy into a single shot of extraordinary magnitude if not crippled. To do so, it must build up its energy by not moving or firing its weapons for two turns. In the next turn, it must remain still and immediately fire its weapon in the shooting phase. Trace a straight line 90cm from the stem of the Blackstone Fortress in any direction desired with the Nova Cannon template. Any ship friend or foe that touches the template with its stem (not its base!) takes 8 lance shots, ignoring shields or any similar mechanism (spores, holofields, etc.). Any ship that touches the center of the template with its stem is immediately destroyed! This same shot can also be used in Exterminatus if the Blackstone Fortress reaches the low orbit table, in which case the planet is destroyed on a roll of 2+. Multiple Blackstone Fortresses (no more than 3) can combine this shot together if they are all never more far apart than the diameter of a Nova Cannon Template. The shot centers from the template placed in the middle of the Fortresses and cannot cross the stem of any one Fortress. Every additional Fortress combined in this way increases the range by 90cm and the number of lance shots on the template by 8. While charging, any ordnance or escorts touching the area between the Fortresses is immediately destroyed. However, capital ships may disrupt the charging process by doing so, taking 8 lance shots that ignore shields and cannot be braced for every Fortress charging. If this happens, each Fortress automatically takes D6 hits, cannot move or shoot in the next turn and must recharge again before firing.

CHAOS SPACE HULK 650 Points

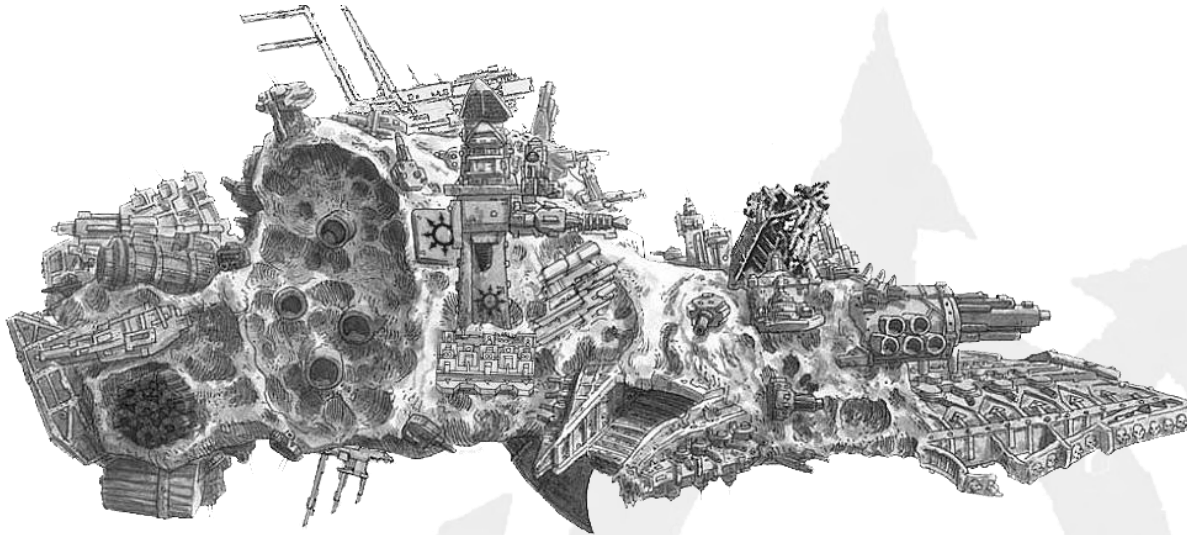

Space hulks are gigantic agglomerations of ancient wrecked ships, asteroids, ice and other such flotsam and jetsam that are cast together after millennia of drifting in and out of warp space. How and why space hulks appear from the Warp and are then drawn back to it is unknown, although there is plentiful evidence for some being controlled or navigated by their inhabitants or some external force. While Tyranid genestealers are known for using Space Hulks to transit across the stars as a vanguard seeking habitable worlds for the Hive Mind, most are simply empty ghost ships, plying the void for eternity. Tales of greedy scavengers meeting horrible fates aboard space hulks are told throughout the Imperium, but there are just as many tales of vast fortunes made from the ancient technology they carry.

Bands of Chaos renegades and traitor Space Marines have been known to make Space Hulks their base of operations, as they serve a convenient mobile headquarters as well as a source of salvageable technology to repair or refit their ancient starships. The World Eaters in particular are known for using Space Hulks not merely as a hidden pirate base but as a jumping-off point for dark crusades in their own right. Angron is known to have used a Space Hulk as the centerpiece of his fleet for the centuries-long Dominion of Fire in M38, a conflict spanning across seventy sectors that took four entire Space Marine Chapters, two Titan Legions and thirty Imperial Guard regiments to finally put down. More recently, he used the Space Hulk *Devourer Of Stars* in 474.M41 to lead his World Eaters traitor Marines and hordes of daemonic creatures to scour the land during the First Armageddon War. After much of the planetary defense force turned traitor and sided with the Ruinous Powers, the remaining loyalists were quickly routed from Armageddon Prime. Only intercession by the Space Wolves prevented the world from falling to Chaos, and several dozen Grey Knights gave their lives to cast Angron back into the Warp in a ward that bound him from returning to the material plane for a hundred years.

| TYPE /HITS | SPEED | TURNS | SHIELDS | ARMOR | TURRETS |
|---------------------------|-------|--|--------------------|-------|-----------|
| Defense/40 | 10cm | Special | 3 | 4+ | 6 |
| ARMAMENT | | RANGE | FIREPOWER/STRENGTH | | FIRE ARC |
| Prow Weapons Battery | | 45cm | 12 | | Front |
| Prow Torpedoes | | Speed: 30cm | 8 | | Front |
| Prow Lance Batteries | | 30cm | 4 | | Front |
| Dorsal Lances | | 60cm | 4 | | All Round |
| Port Weapons Battery | | 45cm | 12 | | Left |
| Port Torpedoes | | Speed: 30cm | 8 | | Left |
| Port Launch Bays | | Swiftdeaths: 30cm Doomfires: 20cm Dreadclaws: 30cm | 4 | | N/A |
| Starboard Weapons Battery | | 45cm | 12 | | Left |
| Starboard Torpedoes | | Speed: 30cm | 8 | | Left |
| Starboard Launch Bays | | Swiftdeaths: 30cm Doomfires: 20cm Dreadclaws: 30cm | 4 | | N/A |
| Aft Weapons Battery | | 45cm | 12 | | Rear |

Note: Space Hulks are so unlike other spaceships that they require a number of special rules, as outlined on the following page. Any rules which are not specifically modified on the next page apply in full to Chaos Space Hulks.

CHAOS SPACE HULK SPECIAL RULES

LEADERSHIP

Due to their enormous size, Chaos Space Hulks always impart a -1Ld modifier. This is applied after all other modifiers and bonuses, including the Warmaster's base leadership, having Chaos Space Marines embarked, etc.

SPECIAL ORDERS

A Space Hulk may not use *Come to New Heading* or *Burn Retros* special orders. Due to their enormous capacity, space hulks may launch up to twice as many attack craft as the number of remaining launch bays the Hulk has available, instead of being limited to the same number as their surviving launch bays.

MOVEMENT

Chaos Space Hulks must move 10cm in a straight line each turn, no more, no less. Space hulks likewise do not have their speed reduced by Blast markers or damage.

Turning

A space hulk may turn up to 45° and only in every second Movement phase. The turn must be taken at the end of the space hulk's 10cm movement. This can be seen more clearly in the diagram below.

Gravity Wells

If a hulk is within the gravity well of a planet or moon at the end of its movement it can make a single 45° turn towards the planet or moon, regardless of whether it turned in its last movement phase. Also, the enormous size and mass of a space hulk means that it creates its own gravity well extending 5cm from the edges of its base. This

affects other ships in exactly the same way as a planetary gravity well and means that other ships can take up a stationary orbit around the hulk. Objects orbiting the hulk are moved along with it until such time as they break orbit. A ship deciding to break orbit must do so before the Space Hulk moves. In other words, no free moves!

DAMAGE

Chaos Space Hulks are so massive that damage applies to them a little differently than to other ships.

Crippling

Space hulks are not crippled by damage like ordinary ships. They are so big that they must be gradually eroded by enemy fire. Due to their massive size and lack of complex systems, roll for the effects of critical hits on a space hulk using the Critical Damage table on this page.

Catastrophic Damage

When a space hulk is reduced to 0 Hp Damage roll on the Catastrophic Damage table. The drifting and blazing hulk results remain unchanged. A plasma drive overload result indicates the Space Hulk is torn apart by internal explosions, no damage is scored on ships nearby, instead the hulk breaks up into asteroid field D3x5cm wide and long. On a warp drive implosion result the hulk is hurled back into the Warp. Replace the hulk with a Warp rift (celestial phenomena, p 45). Any ships caught in the rift are affected immediately.

USING CHAOS SPACE HULKS

A Chaos fleet of any size may include one Chaos Space Hulk. If taken, it must serve as the flagship. It

may not be taken in a fleet that has the Planet Killer, an Activated Blackstone Fortress or ships that must be used as flagships such as the *Terminus Est*. It may not take any Chaos Marks, but other ships still can.

A Chaos fleet including a Space Hulk may have no more than two other battleships. However, there is no minimum point requirement or ship prerequisite for fielding a Chaos Space Hulk, and if desired it may even be taken by itself or only with escorts. It counts as a battleship for purposes of taking another so in order to take a second battleship, the fleet must already have six cruisers and/or heavy cruisers.

Following the restrictions above, there isn't any reason a Chaos fleet cannot use a space hulk in the same manner as a pirate base in the course of a campaign. It could also be the objective of a convoy run scenario where the Space Hulk is caught alone while its fleet was away, counting as ten transports for purposes of selecting an attacking fleet.

CHAOS SPACE HULK CRITICAL DAMAGE TABLE

When receiving critical damage, roll a D6 against the following table:

1-2: Target high energy systems! Roll a D6:

1-2: -1 prow and dorsal lance

3-4: -1 shield

5-6: -1 turret strength

3-4: Target weapons clusters! Roll a D6, affecting only the quadrant the attack originated from:

1-2: -1 launch bay (except prow/aft)

3-4: -1 torpedo strength (except aft)

5-6: -2 weapon battery firepower

5-6: Target thruster assemblies! The Space Hulk must roll higher on a D6 than the number of thruster damage critical hits it has suffered in order to turn.

Damage rolled that does not apply for any reason immediately assumes the next higher level damage on the table. For example, a Weapons Cluster roll of 2 against the prow doesn't apply and would instead count as a 3. Space Hulks cannot repair any critical damage in the course of a battle.

CHAOS SPACE HULK TURNING DIAGRAM

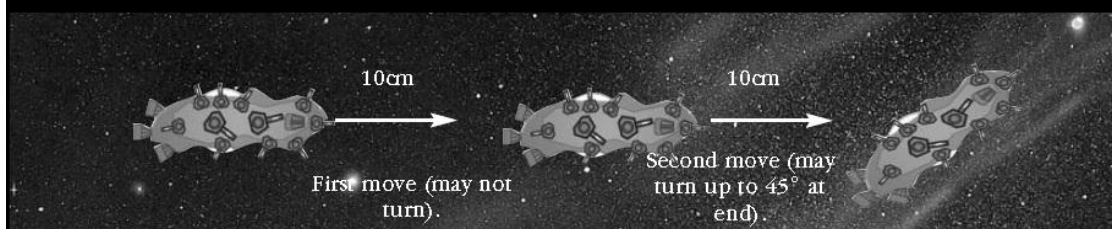

THE SORCEROUS FLEET OF TZEENTCH



FLEET COMMANDER

0-1 Chaos Warmaster of Tzeentch

You can only include a Chaos Warmaster in your fleet if it includes any capital ships. He must be assigned to the most expensive ship and improves its rolled Leadership by +2, to a maximum of 10.

Chaos Warmaster (Ld +2) 100 points
Chaos Warmasters get one re-rolls. The Warmaster may be given an extra re-roll at a cost of +25 points. The Warmaster must take the Mark of Tzeentch.

Chaos Lords

Any capital ship apart from that of the Warmaster may be captained by a Chaos Lord. If so then add +1 to the Leadership rolled for the ship at the start of the game subject to a maximum of 9.

Chaos Lord (Ld +1) 25 points

A Lord may be given a Mark of Tzeentch, providing a re-roll (which he can use for his own ship or squadron only) for +25 points. A ship commanded by a Lord may only be given a Mark of Tzeentch.

Mark of Tzeentch +25 points

The vessel is given command of the Fates by its patron god and gains +1 re-roll.

CAPITAL SHIPS

Battleships

You may include up to one battleship in your fleet for every three cruisers or heavy cruisers. A fleet 1,000 points or more may include the Scion of Prospero as one of its battleships, subject to normal restrictions.

0-1 Scion of Prospero 450 points
Chaos battle barge 410 points
Despoiler class battleship 400 points
Desolator class battleship 300 points

Grand Cruisers

You may include up to one grand cruiser in your fleet for every three cruisers or heavy cruisers.

Heavy Cruisers

You may include up to one heavy cruiser in your fleet for every two cruisers. This includes the heavy cruiser listed below.

Chaos Hecate class heavy cruiser 230 points

0-12 Cruisers

You may include up to 12 cruisers in your fleet, including the cruiser listed below.

Chaos Inferno class cruiser 180 points

Daemonships

Except for the flagship or the Scion of Prospero (if included), any number of the capital ships in a Sorcerous Fleet may be upgraded to Daemonships for the point costs outlined on p.40 of Armada.

A Daemonship may not be commanded by a Warmaster or a Chaos Lord, even if it is the largest ship in the fleet. This is an exception to the normal rule. A Daemon ship may not have a Chaos Space Marine crew. Daemonships in a Sorcerous Fleet may only take the Mark of Tzeentch, paid for separately.

Forces of Chaos: Warp Beasts +25 points

The garish, terror-spawned leviathans of the warp are but playthings to Tzeentch, and he can bind these creatures to the hulls of vessels to be unleashed in a torrent of coruscating fire and nightmare color.

Up to two capital ships (including the flagship) can have daemonic entities and warp beats swirl about its hull, including daemonships. Once per battle, a single enemy ship within 15cm takes D6 hits in the end phase (shields have no effect).

Forces of Chaos: Strand of Fortune . . . +25 points

Tzeentch may offer glimpses of the future to his servants, even those serving his chosen champion.

Any ship led by a Lord of Tzeentch (and not the Warmaster!) may be granted a Strand of Fortune. Once per battle it automatically passes a command check or leadership test- no roll required.

ESCORTS

The fleet may include any number of Chaos escorts.

ORDNANCE

Ships capable of carrying ordnance in a Sorcerous fleet of Tzeentch follow all the rules and options for Chaos Space Marine vessels listed on p.47 of Armada.

THOUSAND SONS

CHAOS SPACE MARINE CREWS

Any capital ship can be designated as having a Thousand Sons Chaos Space Marine crew at +35 points. The ship will be subject to the Chaos Space Marine special rules described in Battlefleet Gothic: Armada. If the ship embarks the Warmaster or a Lord, you can assume that he is also a Chaos Space Marine. Any ship with a Chaos Space Marine crew may have a Mark of Tzeentch.

For +10 points, battleships and grand cruisers with Chaos Space Marine Warmasters, Lords or crews may include Thousand Sons Chosen Terminators, which follow the special rule for Chaos Chosen Terminator boarding actions in Battlefleet Gothic: Armada.

THE PLAGUEFLEET OF NURGLE



FLEET COMMANDER

0-1 Chaos Warmaster of Nurgle

You can only include a Chaos Warmaster in your fleet if it includes any capital ships. He must be assigned to the most expensive ship and improves its rolled Leadership by +2, to a maximum of 10.

Chaos Warmaster (Ld +2) 100 points
Chaos Warmasters get one re-roll. The Warmaster may be given an extra re-roll at a cost of +25 points. The Warmaster must take the Mark of Nurgle.

Chaos Lords

Any capital ship, apart from that of the Warmaster may be captained by a Chaos Lord. If so then add +1 to the Leadership rolled for the ship at the start of the game subject to a maximum of 9.

Chaos Lord (Ld +1) 25 points
A Lord may be given a re-roll (which he can use for his own ship or squadron only) at +25 points. A ship commanded by a Lord may only be given a Mark of Nurgle.

Mark of Nurgle +35 points

The vessel is rank with putrescence and the many plagues of the Lord of Decay. It gains 1 Damage Point and may not be boarded.

CAPITAL SHIPS

Battleships

You may include up to one battleship in your fleet for every three cruisers or heavy cruisers. A fleet 1,000 points or more may include the Terminus Est as one of its battleships, subject to the normal restrictions.

(0-1) Terminus Est 430 points
Chaos battle barge 410 points
Despoiler class battleship 400 points
Desolator class battleship 300 points

Grand Cruisers

You may include up to one grand cruiser in your fleet for every three cruisers or heavy cruisers.

Heavy Cruisers

You may include up to one heavy cruiser in your fleet for every two cruisers. This includes the heavy cruiser listed below.

Chaos Hecate class heavy cruiser 230 points

0-12 Cruisers

You may include up to 12 cruisers in your fleet, including the cruiser listed below.

Chaos Inferno class cruiser 180 points

Daemonships

Up to a third of the capital ships in a Plaguefleet may be upgraded to Daemonships at the additional points cost shown, based upon the type of vessel chosen.

Battleship +85 points
Grand cruiser +65 points
Heavy cruiser +60 points
Cruiser +55 points

A Daemonship may not be commanded by a Warmaster or a Chaos Lord, even if it is the largest ship in the fleet. This is an exception to the normal rule. A Daemon ship may not have a Chaos Space Marine crew. All Daemonships in a Plaguefleet must take the Mark of Nurgle, which is already included in the cost to upgrade them to Daemonships.

Forces of Chaos: Hives of Nurgle +10 points

Pustules, hives, and sores fester upon the ship's cankered hull, seeping an obscuring miasma of corroded debris, waste and filth out into space.

Any capital ships with the Mark of Nurgle may also take Hives of Nurgle. The miasma distorts the ship's silhouette; vessels within 15cm do not benefit from a left column shift when firing at it.

Forces of Chaos: Ark of Pestilence +5 points

During the Gothic War, hulks were found to be relatively intact but with their entire crews slain and their bodies rotted by horrific disease.

Up to three capital ships with the Mark of Nurgle (including the flagship) may also become Arks of Pestilence. Ships boarded by them are also infected by plague in addition to all damage inflicted normally, affecting it the same way as if it suffered a single Fire critical (repaired normally). Ships hulked in this manner do not remain "on fire" and roll normally on the catastrophic damage table.

ESCORTS

You can include any number of escorts in your fleet.

ORDNANCE

Ships capable of carrying ordnance in a Plaguefleet of Nurgle follow all the rules and options for Chaos Space Marine vessels listed on p.47 of Armada.

DEATH GUARD

CHAOS SPACE MARINE CREWS

Any capital ship can be designated as having a Death Guard Chaos Space Marine crew at +35 points. The ship will be subject to the Chaos Space Marine special rules described in Battlefleet Gothic: Armada. If the ship contains the Warmaster or a Lord then you can assume that he is also a Chaos Space Marine. Any ship with a Chaos Space Marine crew may have a Mark of Nurgle. For an extra +10 points, battleships and grand cruisers with Chaos Space Marine Warmasters, Lords or crews may include Death Guard Chosen Terminators, which follow the special rule for Chaos Chosen Terminator boarding actions in Battlefleet Gothic: Armada.

THE BEZERKER FLEET OF KHORNE



FLEET COMMANDER

0-1 Chaos Warmaster

You can only include a Chaos Warmaster in your fleet if it includes any capital ships. He must be assigned to the most expensive ship and improves its rolled Leadership by +2, to a maximum of 10.

Chaos Warmaster (Ld +2) 100 points

Chaos Warmasters get one re-roll. The Warmaster may be given an extra re-roll at a cost of +25 points.

The Warmaster must take the Mark of Khorne.

Chaos Lords

Any capital ship, apart from that of the Warmaster may be captained by a Chaos Lord. If so then add +1 to the Leadership rolled for the ship at the start of the game subject to a maximum of 9.

Chaos Lord (Ld +1) 25 points

A Lord may be given a re-roll (which he can use for his own ship or squadron only) at +25 points. A ship commanded by a Lord may only be given a Mark of Khorne.

Mark of Khorne +20 points

Crewed by homicidal, blood-crazed followers of Khorne, it doubles its value in boarding actions.

CAPITAL SHIPS

Chaos Space Hulk

You may include up to one Space Hulk in the fleet, which must be the flagship if chosen. Bezerker Fleets led by a Space Hulk may have more than two battleships, but other restrictions remain unchanged.

Chaos Space Hulk 650 points

Battleships

You may include up to one battleship in your fleet for every three cruisers or heavy cruisers. A fleet 750 points or more may include the Conqueror as one of its battleships, subject to the normal restrictions.

Chaos battle barge 410 points

Despoiler class battleship 400 points

(0-1) Conqueror 380 points

Desolator class battleship 300 points

Grand Cruisers

You may include up to one grand cruiser in your fleet for every three cruisers or heavy cruisers.

Heavy Cruisers

You may include up to one heavy cruiser in your fleet for every two cruisers. This includes the heavy cruiser listed below.

Chaos Hecate class heavy cruiser 230 points

0-12 Cruisers

You may include up to 12 cruisers in your fleet, including the cruiser listed below.

Chaos Inferno class cruiser 180 points

Daemonships

Up to a quarter of the capital ships (not battleships) in a Bezerker Fleet may be upgraded to Daemonships at the additional points cost shown, based upon the type of vessel chosen.

Grand cruiser +50 points

Heavy cruiser +45 points

Cruiser +40 points

A Daemonship may not be commanded by a Warmaster or a Chaos Lord, even if it is the largest

ship in the fleet. This is an exception to the normal rule. A Daemonship may not have a Chaos Space Marine crew. All Daemonships in a Bezerker Fleet must take the Mark of Khorne, which is already included in the cost to upgrade them to Daemonships.

Forces of Chaos: Bezerker Tide Free

Bloodlust drives a ship's crew forward in a battle frenzy, ignoring their own vessels' defenses. Carriers flush their bays of attack craft to meet their foe as crews leave their posts en-masse to board the enemy.

Any ships with the Mark of Khorne conducting a boarding action may roll D3 extra critical damage rolls if desired, but then it may not take any special orders (including Brace for Impact) in the next turn. Carriers with this Mark may launch up to D3 more attack craft markers of any type if less than 20cm of their target. If they do so, they must Reload Ordnance and not launch in the next turn.

ESCORTS

You can include any number of escorts in your fleet.

ORDNANCE

Ships capable of carrying ordnance in a Bezerker fleet of Khorne follow all the rules and options for Chaos Space Marine vessels listed on p.47 of Armada.

WORLD EATERS

CHAOS SPACE MARINE CREWS

Any capital ship can be designated as having a World Eaters Chaos Space Marine crew at +35 points. The ship will be subject to the Chaos Space Marine special rules described in Battlefleet Gothic: Armada. If the ship contains the Warmaster or a Lord then you can assume that he is also a Chaos Space Marine. Any ship with a Chaos Space Marine crew may have a Mark of Khorne. For an extra 10 points, battleships and grand cruisers with Chaos Space Marine Warmasters, Lords or crews may include World Eaters Chosen Terminators, which follow the special rule for Chaos Chosen Terminator boarding actions in Battlefleet Gothic: Armada.

THE PLEASUREFLEET OF SLAANESH



FLEET COMMANDER

0-1 Chaos Warmaster

You can only include a Chaos Warmaster in your fleet if it includes any capital ships. He must be assigned to the most expensive ship and improves its rolled Leadership by +2, to a maximum of 10.

Chaos Warmaster (Ld +2) 100 points
Chaos Warmasters get one re-roll. The Warmaster may be given an extra re-roll at a cost of +25 points. The Warmaster must take the Mark of Slaanesh.

Chaos Lords

Any capital ship, apart from that of the Warmaster may be captained by a Chaos Lord. If so then add +1 to the Leadership rolled for the ship at the start of the game subject to a maximum of 9.

Chaos Lord (Ld +1) 25 points
A Lord may be given a re-roll (which he can use for his own ship or squadron only) at +25 points. A ship commanded by a Lord may only be given a Mark of Slaanesh.

Mark of Slaanesh +25 points

The ship is full of the sensation-craving followers of Slaanesh, and their siren cries extend into the minds of nearby enemy ships. Enemy ships within 15cm suffer -2 to their leadership value.

CAPITAL SHIPS

Battleships

You may include up to one battleship in your fleet for every three cruisers or heavy cruisers. A fleet 1,000 points or more may include the Wage of Sin as one of its battleships, subject to the normal restrictions.

(0-1) Wage of Sin 430 points
Chaos battle barge 410 points
Despoiler class battleship 400 points
Desolator class battleship 300 points

Grand Cruisers

You may include up to one grand cruiser in your fleet for every three cruisers or heavy cruisers.

Heavy Cruisers

You may include up to one heavy cruiser in your fleet for every two cruisers. This includes the heavy cruiser listed below.

Chaos Hecate class heavy cruiser 230 points

0-12 Cruisers

You may include up to 12 cruisers in your fleet, including the cruiser listed below.

Chaos Inferno class cruiser 180 points

Daemonships

Up to half of the capital ships in a Pleasurefleet may be upgraded to Daemonships at the additional points cost shown, based upon the type of vessel chosen.

Battleship +75 points
Grand cruiser +55 points
Heavy cruiser +50 points
Cruiser +45 points

A Daemonship may not be commanded by a Warmaster or a Chaos Lord even if it is the largest ship in the fleet. This is an exception to the normal rule. A Daemonship may not have a Chaos Space Marine crew. All Daemonships in a Pleasurefleet must take the Mark of Slaanesh, which is included

in the cost to upgrade them to Daemonships.

Forces of Chaos: Veil of Lust +20 points

The dissonant noise becomes so palpable, even the sensors and auguries of enemy vessels are affected.

Any ships with the Mark of Slaanesh may take and be obscured by a Veil of Lust. Ship firing on this vessel using the gunnery table suffers a right-column shift before any other modifiers are applied.

Forces of Chaos: Siren's Summon +25 points

Vivid sounds and images of unspeakably dark pleasures permeate the hulls of enemy vessels and enrapt entire crews to inaction.

Up to two capital ships with the Mark of Slaanesh (including the flagship) may take the Siren's Summon. While within 15cm of a vessel with Siren's Summon, enemy ships cannot take special orders or make leadership checks of any type, including Brace For Impact.

ESCORTS

You can include any number of escorts in your fleet.

ORDNANCE

Ships capable of carrying ordnance in a Pleasurefleet of Slaanesh follow all the rules and options for Chaos Space Marine vessels listed on p.47 of Armada.

EMPEROR'S CHILDREN CHAOS SPACE MARINE CREWS

Any capital ship can be designated as having an Emperor's Children Chaos Space Marine crew at +35 points. The ship will be subject to the Chaos Space Marine special rules described in Battlefleet Gothic: Armada. If the ship contains the Warmaster or a Lord then you can assume that he is also a Chaos Space Marine. Any ship with a Chaos Space Marine crew may have a Mark of Slaanesh. For an extra +10 points, battleships and grand cruisers with Chaos Space Marine Warmasters, Lords or crews may include Emperor's Children Space Marine Terminators, which follow the special rule for Chaos Chosen Terminator boarding actions in Battlefleet Gothic: Armada.

DOOM OF THE ELДАР

YRIEL'S RAIDERS AND THE WARFLEETS OF THE CRAFTWORLD ELДАР

Although Eldar Corsairs are a constant threat to merchant shipping, they very rarely pose a major threat to Imperial battlefleets. The same cannot be said of the dozens of fleets of Eldar ships that protect each Eldar Craftworld. Each of these Craftworld warfleets is a deadly and highly potent force that is capable of laying waste to an entire sub-sector.

THE CRAFTWORLD OF IYANDEN

Thousands of years ago Eldar civilization was all but destroyed in a catastrophe brought about by their own decadent hedonism, the only survivors fleeing from their planets in giant space vessels known as Craftworlds. Iyanden was the largest of all of the Eldar Craftworlds and its people the most numerous. It drifted serenely through the void of space, far away from the inhabited planets of other races.

Craftworlds, though spacecraft, are vast beyond comprehension. They are not merely huge capital ships ploughing through space with a surrounding escort of smaller vessels. They are not even akin to vast cities, as some of the largest star forts of the Imperium might be considered, but rather are immense spacefaring worlds accompanied by vast armadas, the

likes of which might otherwise be set aside to defend an entire system or even sub-sector. Whole battlefleets cluster around key points and stations all across the thousands of miles of the Craftworld's exterior as smaller, nimbler craft rush and surge across its surface in a constant shimmering patrol. Beneath this dizzying tide of vessels, under clear crystalline domes through which ground and stars might gaze upon one another, the Eldar live their lives aboard these spaceborne worlds. Since the Fall of their race and the decline of their empire, those Eldar who seek to continue their ancient way of life have done so aboard these Craftworlds, on an aeons long course across the galaxy, as much in flight as in search of any kind of destination, for the Eldar race is a dying one, and even the exodus of these great Craftworlds will do little to avert that.

THE CRAFTWORLD AT WAR

It is possible for an Eldar to simply traverse the Webway on foot, moving directly from a Craftworld to a wraithgate on some far distant world. Such portals, however, are invariably far too small to quickly deploy an entire army, and hence such methods are used by few amongst the Eldar – only the Rangers, the Harlequins and other distant wanderers tread these slender paths. On occasion however, the Eldar's destiny will draw them to fight on a world disconnected from the Webway by the millennia of tragedy which have befallen the Eldar. The Eldar warhosts may be dispatched aboard vast wings of Eldar attack craft – Vampire Raiders and the like – which are able to ferry substantial forces rapidly via the Webway. At other times, a force so vast may be required that the aircraft and skimmers of the Eldar army itself are insufficient. It is at such times that the Eldar battlefleets will be readied. The warhosts of the Eldar will assemble aboard the fleet, which will then depart the Craftworld, itself using the webway. As such, a Craftworld's docks are not

really simple holding areas for its fleet, but rather they are immense wraithgates attached to the Craftworld itself from where the fleet may enter the Webway. Such a fleet is then able to exit the Webway by another point elsewhere in the depths of space using are the largest of the Eldar's wraithgates - portals so sizeable that whole fleets may emerge from them when activated.

These journeys may bring a fleet into orbit directly around their chosen destination, or it may be necessary for them to emerge some distance away, but either way the pace of which Eldar vessels are capable of moving means they will descend upon their target very swiftly indeed. Eldar fleets employ the Webway in this manner in order to launch horrifyingly sudden attacks upon unsuspecting enemy vessels, emerging from the Warp while their enemy remains unready and ill-prepared for battle. When it is the Eldar's will to attack a world, the emerging fleet will take up position around their chosen planet as quickly as possible. The largest craft in an Eldar warfleet possess internal wraithgates, through which they can swiftly deploy their armies to the ground while at the same time providing orbital support and further landings from their notoriously fast attack craft. If the world to be attacked no longer possesses any viable warp portals, the Eldar will instead descend upon it in a howling flock of Vampire Raiders, Phoenix bombers and Nightwing fighters, tearing apart their enemies so rapidly that defence is all but an impossibility.

A Craftworld's course is also aided greatly by the many wraithgates spread across the stars. As a Craftworld's Seers scrye out its course, small shoals of Shadowhunters move far ahead through the Webway, hunting out potential enemies and scouring the way clear. If encountered, enemy fleets or patrols who may present a danger to the Craftworld's safe passage will likely find themselves the unsuspecting targets of the Eldar's powerful warships long before

even becoming aware of the Craftworld's imminent arrival.

THE ELДАР WARFLEETS

The sheer size of a Craftworld means that each individual vessel possesses several full battlefleets, stationed at convenient points along the Craftworld as it journeys through space. Each fleet might typically number from ten to twenty warships and is commanded by an Eldar Admiral, though it will inevitably also rely greatly on advice and counsel from the Craftworld's Seers. The vessels themselves are crewed by those Eldar who have chosen the Path of the Mariner, symbolized by the blue and white feathered birds of Eldar myth who guide the Eldar southward and westward over the seas. Helmsmen and Wayfarers, dedicated specialists within this path, each provide their own valuable skills as part of a vessel's crew, allowing the Eldar to navigate the Webway with a mastery unknown to most. The Shadowhunter



patrols usually remain independent of these battlefleets, moving to and fro about the Craftworld as they please. These smaller vessels lack the dedicated crews of the larger capital ships and are often crewed by those Guardians who were once embarked upon the Path of the Mariner. The compact size and customary agility of these sleek escorts allows them to approach much closer to the Craftworld than would be expected for true spacecraft. Shadowhunters put these unique traits to good use as they defend the Craftworld's delicate wraithbone exterior from encroaching asteroids or space junk which might be attracted by the force of gravity, blasting such interlopers into pieces small enough to rain harmlessly down on the Craftworld below. At other times the Shadowhunters can be seen playfully stalking the Eldar fighters which patrol the Craftworld's lower atmosphere, tracking and chasing the smaller vessels with a precision unthinkable for escort sized vessels. As need dictates, small groups of Shadowhunters will eschew their normal role, band together and join their larger counterparts in defense of the Craftworld.

YRIEL'S RAIDERS

Yriel had led the Iyanden fleet as its Autarch, the supreme commander of an Eldar war host, having an exceptional understanding of the art of war and also the many Eldar paths. Unlike an Exarch, an Autarch is not obsessed with and lost to conflict, instead favoring command roles. The Autarch is responsible for coordinating the numerous elements of the war host. Despite this tactical role, the Autarchs are also highly skilled in combat, being able to call upon the vast armory of the Eldar for weapons of war. In this role Yriel earned many accolades, and though he was considered one of the greatest Eldar naval tacticians to have ever lived, his character was flawed by the sin of pride. When Iyanden had been threatened by a Chaos space fleet raiding out of the Eye of Terror, Yriel had led the fleet on a pre-

emptive attack on the Chaos Fleet's flagship, leaving Iyanden Craftworld unprotected. He only returned just in time to stop a suicide attack by a small flotilla of Chaos raider ships, who nonetheless managed to damage the Craftworld. Expecting to be feted and honoured for his victory, Yriel was deeply angered when he was called upon to defend his course of action. Claiming that his record should speak for itself, Yriel refused to enter into the debate, leaving his old friend Kelmon no choice but to elect a new High Admiral in his place. Bitter with rage, Yriel vowed that he would never set foot on Iyanden again. He and a small band of followers left the Craftworld and formed an Eldar raider company that became the single most powerful Eldar pirate force operating in the galaxy.

THE TYRANID INVASION OF IYANDEN CRAFTWORLD: 992.M41

More than fifty years later, from out of the darkness of intergalactic space exploded the Tyranids, and Iyanden became the scene of the Eldar's first encounter with the Tyranid Swarm, the all-consuming menace whose locustlike advance through the galaxy has since enveloped hundreds of human worlds. The first warning the Eldar of Iyanden had of their fate was brought by the Craftworld's far roaming Rangers, Eldar whose instincts drive them to a life of exploration and danger, and who secretly monitor the planets and alien races near their Craftworld. The news that the Rangers brought was dire: a Tyranid hive fleet of immense proportions was heading towards Iyanden Craftworld. Already over a dozen Imperial planets had been consumed in the Tyranid's advance and, although the Imperium was mounting furious counter-attacks as and when it could, it would be months until a major Imperial taskforce could be mobilised to deal with the threat. By then Iyanden would have been overrun. Farseer Kelmon, leader and spiritual head of the Craftworld, called together

the Eldar of Iyanden and warned them of the impending Tyranid assault. Each Eldar Craftworld has a great hall, known as the Place of Answering, which is capable of holding every member of the Craftworld. At times of crisis the Eldar meet there, so that all may know of the peril that faces their Craftworld, and so that any Eldar may voice an opinion on the course of action that should be taken. Only once all views have been debated, and a consensus of opinion reached, will the Craftworld's Farseer decide on the course of action to be taken.

The debate on the action to take against the Tyranid hive fleet was heated and prolonged. The more conservative elements of the Craftworld argued for a policy of isolation, shielding the Craftworld behind a powerful psychic shield in an attempt to avoid all contact with the Tyranids. The more aggressive elements wanted to attack the Tyranids immediately, dispatching the fleet to destroy the Tyranids before they reached the Craftworld. Both courses of action were deeply flawed, however, because they took no account of the sheer size of the Tyranid Swarm. It took a powerful speech from the Ranger Irilith, who had seen the hive fleet at first hand and understood the terrible threat that it represented. For over an hour she drove home to all present that the hive fleet was too large to hide from, or for the Eldar fleet to defeat on its own. It would take the combined efforts of every Eldar on Iyanden to have any chance of turning back the Tyranids. Even then they might not succeed in defeating the alien menace. A hush fell on the Hall as Irilith finished her speech. No more needed to be said, for all the Eldar present now realised the sheer enormity of the task ahead. Farseer Kelmon rose and ordered that the Eldar prepare the defences of Iyanden Craftworld. All elements of the fleet would be recalled, and every single Eldar must take on the Warrior Aspect of Warlock, Guardian or Aspect Warrior. The entire gigantic Craftworld would be fortified, for there could be no doubt that the Tyranids would breach their outer defences and land on the ship. Help must be requested from the



other Eldar Craftworlds. The Avatar, the embodied spirit of the Craftworld's War God, must be awakened to take part in the battle. And, most terrible of all, all of the Craftworld's ancient spirit stones must be plucked from their resting places and implanted in metal fighting bodies to battle as Ghost Warriors. When an Eldar dies their spirit is released into a gem known as a spirit stone, which is grafted into the very structure of their Craftworld to preserve the dead Eldar's consciousness. Thus, each Craftworld is a living thing which preserves a little of the once great Eldar civilisation. By risking the destruction of the Craftworld's spirit stones, Kelmon

risked the destruction of Iyanden's culture and racial memory. It was a grave chance to take, but Kelmon knew that the Ghost Warriors could make the difference between victory and defeat in the struggle that was coming.

The first Tyranid Hive Swarms attacked Iyanden just twenty days later. By then the Craftworld had already been isolated for over a week by a Tyranid psychic blockade which made it extremely difficult for the other Eldar Craftworlds to send help. Apart from a few scattered units that made it through, Iyanden would be fighting the Tyranids on its own.

Nonetheless, the first Tyranid waves were dealt with easily and efficiently by the Eldar fleet. The Eldar's spacecraft were faster, more manoeuvrable and had longer ranged weapon than their opponents. In battle after battle the Eldar spacecraft destroyed the lumbering hive ships while only suffering minimal casualties themselves. For a while it looked as if the fleet might be able to hold off the Tyranids on its own, as wave after wave of Tyranids were wiped out. But Farseer Kelmon was not convinced. Already the ability of the Craftworld's forges to replace destroyed Eldar spacecraft was being outstripped by the casualties being suffered in the deep space battles that raged around the Craftworld. The Eldar fleet was being ground down in a massive battle of attrition; a battle that only the Tyranids could hope to win.

As if to confirm Kelmon's worst fears the next Tyranid wave was massive, very nearly twice the size of any that had hit the Craftworld so far. The Eldar fleet suffered terrible casualties in its attempt to hold the Tyranids off, and for the first time was unable to stop them landing on the Craftworld. Although the landing was wiped out before any serious damage was done, the Eldar fleet as a large-scale fighting force had ceased to exist. Still there was hope, especially if the wave had represented the Tyranid's main assault force. Eldar spirits were raised even more as the next wave turned out to be tiny in comparison to what had come earlier. Although the weakened fleet couldn't keep all of the swarms away from the Craftworld, the landings that were made were easily isolated and destroyed. For a short while it seemed that the Eldar had weathered the storm. Then Iyanden was hit by two huge attacks in succession. The pitiful remnants of the Eldar fleet opposed the Hive Swarms as best they could, but were swept aside by a tide of alien spacecraft. Iyanden was all but engulfed as horde after horde of Tyranid Warriors, Genestealers, Gaunts and Carnifexes were disgorged onto the Craftworld. Huge battles erupted all over Iyanden, the fighting

bitter and close ranged with enemy forces often only separated by the width of a corridor of wraithbone wall, as the Eldar desperately attempted to beat off the alien invaders. Often they succeeded, but the Fortress of Tears, Shrine of Asuryan and, most terrible of all, the ancient Forests of Silence, all fell to the Tyranid hordes. The Eldar counter-attacked, the raging figure of the Avatar leading the Craftworld's Aspect Warriors and Ghost Warriors in a berserk orgy of destruction which recaptured the Forests of Silence from the Tyranids. It is said that the Eldar Warriors wept tears of rage and sorrow to see the damage inflicted on the ancient forest domes of their Craftworld. Slowly the Eldar managed to turn the tide on the Tyranids and gain the upper hand, forcing them back onto the defensive. And then another huge Tyranid wave arrived, the third in succession, and the largest yet. As swarm after swarm flickered into existence on the Eldar's scanners, Kelmon knew that, barring a miracle, Iyanden Craftworld was doomed...

THE HERO RETURNS

When he heard of the Tyranid's assault on Iyanden, Yriel did his best to ignore the terrible peril that threatened his old Craftworld. But proud though he

"An Eldar rune, each of which has specific mythological significance, represents every Craftworld. One



such rune is the Shrine of Asuryan. Asuryan is the oldest and greatest of the ancient gods of the Eldar, the father of the gods, and the ultimate ancestor of all living things. This is the symbol of Iyanden Craftworld, whose name means Light in the Darkness, another way of referring to burning shrine of Asuryan."

was, righteously angry though he was, Yriel could not leave Iyanden to its fate in this, its very darkest hour. Battling his way through the Tyranids' psychic blockade, Yriel swept to the aid of his people and arrived just in time. Like a thunderbolt from the blue Yriel and his raider fleet smashed into the Tyranid Hive Swarms. He was quickly joined by the few remaining craft of Iyanden's fleet, and together the combined Eldar space fleets tore the Tyranid Swarms apart. Two more waves of Tyranid Hive Swarms attacked the Craftworld, only to meet the same fate. Not a single Tyranid ship reached the Craftworld, though the cost to the Raiders was dear. Bloodied but unbowed the Raiders prepared to sell their lives to the last in order to turn back the next wave of Tyranids. On the bridges of the Craftworld and of the circling Eldar ships vigilant eyes watched the scanners, waiting for the first tell-tale blip that would indicate the direction of the next assault. Minutes passed, then hours, and with a growing sense of wonder the Eldar realised that no more Tyranid Swarms were coming – the assault was over. The hive fleet had been destroyed! But on Iyanden Craftworld the war went on. The Tyranid hordes that had been fighting a tenacious rearguard action awaiting the aid of the rest of the hive fleet now turned like cornered rats and hurled themselves at the Eldar. Caught by surprise the Eldar staggered back, desperately trying to hold the suicidal Tyranid onslaught. The Fortress of the Red Moon fell to a surprise attack, and for a moment it seemed that with victory within their grasp the Eldar would be defeated. But, for the second time, Yriel led his Raiders to the rescue of the Craftworld. Disembarking from their orbiting spacecraft the Raiders joined with the battered defenders of Iyanden Craftworld and, yard by yard, step by step, forced the Tyranids back. A final wild charge led by the Tyranid Hive Tyrant was annihilated by the combined efforts of the Avatar, Yriel and the Ghost Warriors, and then in a series of vicious one-sided battles the last of the Tyranids were hunted down



and destroyed. The Tyranid attack on Iyanden Craftworld was over.

The Tyranids had been defeated. But the victory was a hollow one. Though the Eldar had repulsed the invaders, the cost was enormous. Their once-proud world stood in ruins, and four-fifths of the inhabitants were dead or lay dying in its shattered halls. Iyanden's mighty space fleet was a pitiful shadow of its former self; the blasted remains of its majestic spacecraft and their brave crews hanging silent and weightless in space. But all this could be rebuilt, maybe not for hundreds of generations, but one day in the distant future. What was lost forever were the souls of the Eldar whose spirit stones had been destroyed in the battle against the Tyranids. The massive destruction wrought upon the people and Ghost Warriors of Iyanden dealt the Craftworld a blow from which its culture would never fully recover.

CRAFTWORLD ELДАР SPECIAL RULES

ELDAR LEADERSHIP

All Eldar ships add +1 to the Leadership score generated on the Leadership table on page 10 of the Rulebook, giving them a Leadership value between 7 and 10. Due to their unique method of movement, the Eldar may not use the following special orders: All Ahead Full, Burn Retros, Come To New Heading. Note: because Eldar ships cannot use All Ahead Full special orders, they also may not ram. An Eldar fleet containing any Craftworld Eldar vessels has an attack (or initiative) rating of 3.

ELDAR SHIP MOVEMENT

The movement rules here are identical to those on p.129 in the Rulebook and replace the normal movement rules used by other fleets. Assume anything not modified below applies normally to the Eldar. Eldar ships move in their Movement phase and in the Ordnance phase of their own turn. Note that they do not move in the Ordnance phase of the enemy's turn. Before an Eldar ship moves, it may turn to face any direction. It always turns before it moves and then remains facing in that direction until the start of its next move. Work out the speed an Eldar ship can move at after it has turned. Its speed depends on its facing towards the sunward table edge. All Eldar ships have three speeds (for example, 10/20/30). The first is used if the sunward table edge is in the Eldar ship's front fire arc; the second is used if the sunward table edge is in its rear fire arc; and the third is used if the sunward table edge is in its left or right fire arcs. If the sunward table edge lies on the line between two fire arcs, the Eldar player may choose which he or she uses.

Eldar ships have no minimum move distances. They move from zero up to the maximum distance allowed by the direction of the sun. After their initial turn they travel in a straight line and may not make additional turns as they move. As noted above, the Eldar move twice in each of their turns. The second move is made in the Ordnance phase after any

ordnance is moved, but apart from this all the rules described for Eldar movement will apply.

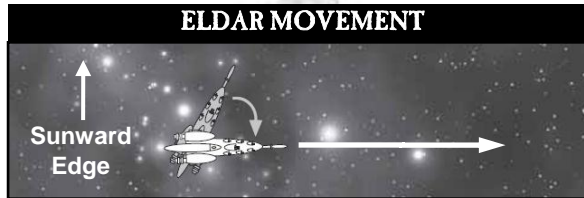

Craftworld and Corsair Eldar vessels follow similar movement rules. Here a Hellebore class Corsair escort has Speed 10/20/30. At the start of its move, it turns in the direction shown, so that the sunward table edge is in its left fire arc. This gives it a speed of 30cm. It can then move up to 30cm straight ahead.

BLAST MARKERS AND GRAVITY WELLS

Eldar are affected by Blast markers in the same way as other ships without shields – they will take a point of damage on a D6 roll of 6 and reduce their speed by 5cm that turn. Gravity wells allow Eldar to curve their normally straight line move around the planet and so the ship may make a free turn towards the planet at the end of its move (since it can turn in any direction at the start, there is no additional benefit at the start of its move).

HOLOFIELDS

Against attacks that use the Gunnery table, the holofields cause one column shift to the right, in addition to any other column shifts for range or Blast markers. Against any other form of attack (lances, torpedoes, etc), roll to hit an Eldar ship as normal, but the Eldar player may then make a saving roll for his holofields: Note that holofields do not negate hits from moving through Blast markers, exploding ships and celestial phenomena. They do, however, work against ordnance hits, hit-and-run raids, boarding actions, ramming or Nova Cannon. Note that against Nova Cannon, holofields save against the shell hit,

not the subsequent damage rolls. For example, if an Eldar vessel is hit by a Nova Cannon round and fails its save, it must immediately take as many hits as the damage roll allocates unless it successfully Braced for Impact beforehand and then passes its brace rolls.

CRAFTWORLD ELДАР WEAPONS

Pulsar Lance

Pulsar lances fire volleys of high energy laser bolts. These count as lance shots, and hit on a 4+ no matter what the target's armor. However, if a pulsar lance shot hits, then you may roll to hit again and you may keep on rolling to hit until you miss or the lance has scored a total of 3 hits.

Shadow Lance

Although larger capital ships employ the powerful Pulsar lance, the vast energy arrays required to power such weaponry are far too large to be mounted on the necessarily swift and nimble Shadowhunters. Instead, smaller Eldar vessels are armed with the Shadow lance – a less powerful version of the same Eldar laser technology. Shadow lances count as typical lances in every respect (ie. no multiple shots).

Weapon Batteries

Eldar weapons batteries are short-ranged weapons that unleash a torrent of fire. They employ sophisticated targeting systems which make them very accurate even at extreme angles of attack. To represent their accuracy, Eldar weapons batteries count all targets as 'closing' on the Gunnery table, no matter what the target's actual aspect is (defenses are still targeted as such). This aside, all the normal rules apply.

Torpedoes

All Eldar ordnance use sophisticated targeter scrambling systems to make themselves virtually undetectable until they strike. To represent this, defensive turrets only hit Eldar torpedoes on a roll of 6, rather than on a roll of 4 to 6 as is normally the

case. In addition, the highly accurate targeting sensors on Eldar torpedoes allow you to re-roll the dice to hit for any torpedo that misses a target on the first attempt (the second roll stands). Eldar torpedoes must make this re-roll when coming in contact with a ship, even if the ship is already destroyed.

Attack Craft

Eldar attack craft benefit greatly from the Eldar's grasp of technology and the skills of their crews. To represent this, defensive turrets only hit any Eldar attack craft on a roll of 6, rather than on a roll of 4 to 6 as is normally the case. Nightwing fighters function exactly as Corsair Eldar Darkstars in that they are resilient, meaning they get a 4+ save once per ordnance phase whenever they come in contact with enemy ordnance.

Phoenix bombers function exactly as Corsair Eldar Eagles. The highly accurate targeting sensors on Phoenix bombers allow you to re-roll the dice to determine the number of attacks they make (the second roll stands). Attack craft carriers may also be

equipped with torpedo bombers for +15 points per launch bay, with these functioning the same way as other Eldar torpedoes. Additionally, for the cost listed in their special rules, certain vessels with launch bays may be equipped with Vampire raiders, which serve as assault boats with a speed of 25cm.

Aspect Warrior Hosts

Unlike Eldar Pirates, who rely on the same self-serving rogues who crew their ships to conduct raids and boarding actions, Eldar Craftworld vessels are able to go to war carrying hosts of Eldar Aspect Warriors who form fighting contingents aboard their ships. Many of the Aspect Warrior shrines excel at the kind of rapid assaults which are ideally suited to teleport and other hit-and-run attacks and hence specialize in attacking enemy vessels in this manner. Certain ships in an Eldar fleet are permitted to carry Aspect Warrior Fighting Crews as chosen from the fleet list, adding +2 to their dice roll when fighting in a boarding action, or +1 to the dice roll when conducting a hit-and-run attack.



ELDAR CRITICAL DAMAGE TABLE

2D6 EXTRA DAMAGE RESULT

2. **Infinity circuit damaged.** The ship's infinity circuit, which aids control and internal communications, is damaged by the hit. The ship's Leadership is reduced by -1 until the damage can be repaired.
3. **Keel armament damaged.** The keel armament is taken off line by the hit and may not fire until it has been repaired.
4. **Prow armament damaged.** The ship's prow is ripped open. Its prow armament may not fire until it has been repaired.
5. **Mast lines severed.** The systems that allow the ship to alter the angle of the sails and turn swiftly are broken by the hit. Until the damage is repaired, the ship may only turn up to 90° before it moves.
6. **Mainsail scarred.** The ship's main solar sail suffers surface damage, reducing the amount of energy it can store. Each of the ship's speeds is reduced by 5cm until the sail is repaired.
7. **Superstructure damaged (+1Hp).** The hit tears into the ship, causing a small breach. Excess strain on the ship's hull could increase the damage. Until the damage is repaired, roll a dice every time the ship turns over 45°. On a roll of 1, the ship suffers 1 extra point of damage.
8. **Mainsail shredded.** The solar cells of the mainsail are torn to tatters by the hit. The ship cannot move in the Ordnance phase until the damage is repaired.
9. **Infinity circuit smashed (+1Hp).** The fine crystal matrix of the infinity circuit is shattered by the hit. The ship's Leadership is reduced by -3. This damage may not be repaired.
10. **Holofield generators destroyed.** The holofield generators are smashed beyond repair by the hit. The ship no longer benefits from its holofields. This damage may not be repaired.
11. **Hull breach (+D3Hp).** A huge gash is torn in the ship's hull, causing carnage among the crew.
12. **Bulkhead collapse (+D6Hp).** Internal pillars buckle and twist and whole compartments crumple with a scream of tortured wraithbone. Just pray that some of the ship holds together!

FLAME OF ASURYAN, YRIEL'S FLAGSHIP 320 Points

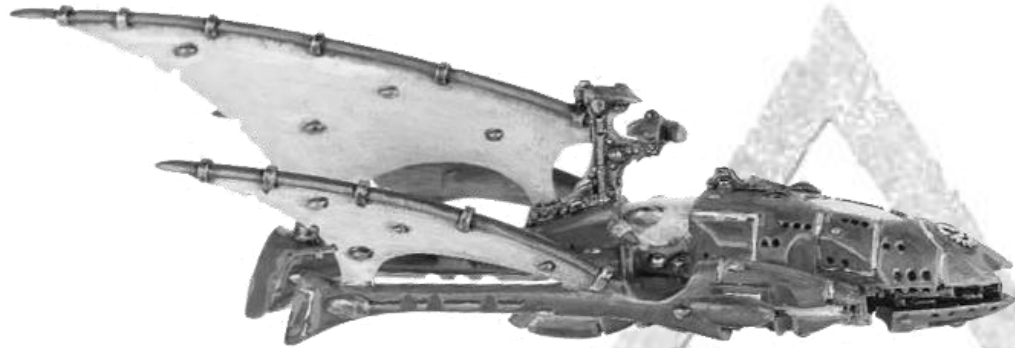

| TYPE /HITS | SPEED | TURNS | SHIELDS | ARMOR | TURRETS |
|----------------------|----------------------------------|--------------------|-------------|--------------|---------|
| Cruiser/8 | 10/20/25cm | Special | Holo-fields | 5+ | 0 |
| ARMAMENT | RANGE | FIREPOWER/STRENGTH | | FIRE ARC | |
| Prow Weapons Battery | 30cm | 16 | | Front | |
| Keel Launch Bay | Nightwing: 30cm Phoenix: 20cm | 4 | | N/A | |
| Keel Pulsar Lance | 30cm | 1 | | Front/Left | |
| Keel Pulsar Lance | 30cm | 1 | | Front/ Right | |

Special Rules: The Flame of Asuryan embarks the most fearsome members of Yriel's own pirate warband, which count as an Aspect Warrior fighting crew. This vessel may take Vampire raiders as part of its point cost. It is a unique vessel, only one may ever be included in the fleet

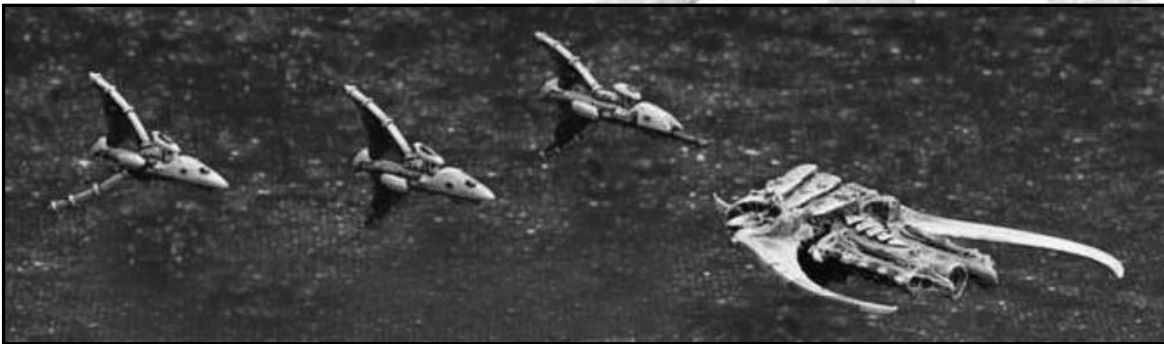

At the heart of Iyanden lies the Shrine of Asuryan. It is here that the most powerful and wise of Iyanden's leaders gather for all talk of war and it is here that the armies of Iyanden muster when the time comes. There is no place more sacred, nor more heavily guarded within the entire Craftworld. At the center of this great shrine burns a constant flickering fire, the Flame of Asuryan itself – a beacon, a symbol of hope to the Eldar of the Craftworld. It is said that the Flame of Asuryan is the burning fire with which the Eldar will claim victory over all who would attack the Craftworld, though it is also said that should the flamed ever go out, Iyanden's light will diminish also. When Yriel led the Craftworld's fleet, he was considered to be the favored of Asuryan, and amongst his many great titles earned himself the honorific of 'Bearer of the Flame', and duly renamed his flagship *The Flame of Asuryan* accordingly.

The Flame of Asuryan is magnificent, even by the standard of Dragonships. It bears three great sails - one borne upon its long elegant spine, and another pair each mounted atop the great outriggers to its flanks, both of which also bear deadly pulsar lances. *The Flame of Asuryan* bore Yriel to many great victories at the head of the Iyanden fleet and he would give little thought to parting with the vessel once his own rank was lost and his own place amongst the Craftworld taken from him. Instead, he and his most loyal followers departed, Yriel himself still aboard his mighty flagship. By such means did the *Flame of Asuryan* come to depart the Craftworld of Iyanden.

When Hivefleet Kraken descended upon Iyanden, Yriel made no attempt to aid his former home, but when the Tyranids overran Iyanden and threatened the Shrine of Asuryan itself, he could no longer ignore its calling. Returning at the head of a mighty fleet of raiders who he had gathered about him in his years of exile, Yriel smashed aside the Tyranid fleet.

CRAFTWORLD ELДАР DRAGONSHIP 260 Points

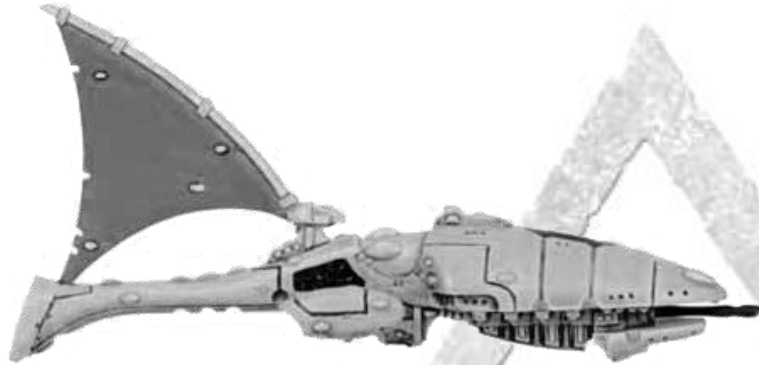

| TYPE /HITS | SPEED | TURNS | SHIELDS | ARMOR | TURRETS |
|------------|------------|---------|------------|-------|---------|
| Cruiser/8 | 10/20/25cm | Special | Holofields | 5+ | 0 |

Choose one of the following prow weapons for each Dragonship in the fleet as part of its point cost.

| ARMANENT | RANGE | FIREPOWER/STRENGTH | FIRE ARC |
|----------------------|-------|--------------------|----------|
| Prow Weapons Battery | 30cm | 14 | Front |
| Prow Pulsar Lance | 30cm | 3 | Front |

Choose one of the following keel weapons for each Dragonship in the fleet as part of its point cost.

| ARMANENT | RANGE | FIREPOWER/STRENGTH | FIRE ARC |
|-----------------|----------------------------------|--------------------|----------|
| Keel Torpedoes | Speed: 30cm | 8 | Front |
| Keel Launch Bay | Nightwing: 30cm Phoenix: 20cm | 4 | N/A |

Special Rules: Dragonships equipped with launch bays may take Vampire raiders for +10 points.

“Those Eldar ships were all over us. I’ve never seen anything move quite like them. They’d rush in and hit us with volleys of laser fire and missiles, and then they’d keel over and be away before we could engage them properly. They didn’t have shields like our void shields, and there ships were fragile too, so if we could hit we’d do them some serious damage. But our augers just couldn’t get a proper fix on them, so hitting them wasn’t easy, not easy at all. If the rest of the flotilla hadn’t got back when it did, I think we’d have been doomed.”
 - Captain Steinback, After Action Report

Dragonship is the collective name given to the larger classes of Eldar vessel. The term Dragonship does not refer to any particular armament or configuration, but rather to a variety of vessels adhering to the same basic principles, designed for the same basic roles. Within this larger grouping, individual configurations or combinations of weapons give individual classes their proper name – always a variation on the phrase ‘Dragon’, representing different aspects of the creature of the same name from Eldar myth. Those Dragonships which are piloted in large part, or even exclusively, by spirit stones, for example, are referred to as Ghostdragons, while larger vessels which have been designed to operate away from the craftworld for great lengths of time are often referred to as Void Dragons. Different styles of Dragonship can vary greatly, with different numbers of sails, different armaments and even variations in size.



CRAFTWORLD ELДАР WRAITHSHIP 160 Points



| TYPE /HITS | SPEED | TURNS | SHIELDS | ARMOR | TURRETS |
|------------|------------|---------|------------|-------|---------|
| Cruiser/6 | 10/20/25cm | Special | Holofields | 5+ | 0 |

Choose one of the following prow weapons for each Wraithship in the fleet as part of its point cost.

| ARMAMENT | RANGE | FIREPOWER/STRENGTH | FIRE ARC |
|----------------------|-------|--------------------|----------|
| Prow Weapons Battery | 30cm | 8 | Front |
| Prow Pulsar Lance | 30cm | 2 | Front |

Choose one of the following keel weapons for each Wraithship in the fleet as part of its point cost.

| ARMAMENT | RANGE | FIREPOWER/STRENGTH | FIRE ARC |
|-----------------|----------------------------------|--------------------|----------|
| Keel Torpedoes | Speed: 30cm | 4 | Front |
| Keel Launch Bay | Nightwing: 30cm Phoenix: 20cm | 2 | N/A |

“The mind of the Farseer is utterly inhuman in its depth and complexity. Without mercy or moral feeling his consciousness stands upon the edge of spiritual destruction. That he does not fall must be the result of constraints and balances which only an Eldar could understand. To a mere human it is another reminder that we are but children in comparison to that ancient and powerful race.”

– Inquisitor Czeverk

Like all the starships of the Eldar, Wraithships are made from wraithbone, a material drawn as raw energy from the Warp and shaped into matter by psychic craftsmen known as Bonesingers. The Wraithbone forms the living skeletal core of the spaceship around which its other structures are arranged. The wraithbone also provides channels for psychic energy. This facilitates internal communication, transmits power and enables the spaceship to act as an organically integrated whole. The wraithbone core of a spaceship is surrounded by a structure which is literally grown into the required shape by Bonesingers. These Eldar use their psychomorphic talents to shape bulkheads, walls, floors and conduits into a shell that completely surrounds the wraithbone core and forms the hull and major internal divisions of the spaceship. Most of a spaceship’s operating systems are connected directly to the wraithbone core. The many thousands of systems draw power through the wraithbone and are constantly monitored and controlled through it.

Because of the unique practices of Eldar psychic engineering, Eldar spaceships resonate with sympathetic psychic energy. The Wraithbone core provides a psychic channel through which an Eldar can control mechanical functions. In this way, Eldar attuned to the very essence of their spaceship guide it, making countless minute adjustments to the trim of the great solar sails to draw every fraction of energy from the solar winds. This is also the key to the legendary elegance and almost birdlike agility of the Eldar Wraithships. Their pilots literally feel the solar wind on the ship’s sails, they sense the flex of the ship’s structure, the tension and movement of its Wraithbone skeleton. Like a hawk soaring on a thermal or diving to clutch at its prey, a Wraithship can turn in the wind, circling and swooping to hunt its own prey – the spaceships of its enemy.



CRAFTWORLD ELДАР SHADOWHUNTER 40 Points



| TYPE /HITS | SPEED | TURNS | SHIELDS | ARMOR | TURRETS |
|------------|------------|---------|------------|-------|---------|
| Cruiser/6 | 15/20/30cm | Special | Holofields | 4+ | 0 |

Shadowhunters are commonly armed with either weapon batteries or shadow lances as part of their as part of their point cost. Choose one of the following weapons for each Shadowhunter in the fleet as part of its point cost. An escort squadron may consist of Shadowhunters armed with different armaments.

| ARMAMENT | RANGE | FIREPOWER/STRENGTH | FIRE ARC |
|----------------------|-------|--------------------|----------|
| Prow Weapons Battery | 30cm | 3 | Front |

OR

| ARMAMENT | RANGE | FIREPOWER/STRENGTH | FIRE ARC |
|-------------------|-------|--------------------|----------|
| Prow Shadow Lance | 30cm | 1 | Front |

Special Rules: Shadowhunters are so nimble that they can even pursue attack craft with ease, harrying the smaller vessels with an agility impossible for other escorts. When coming in base contact with any attack craft, they may re-roll a failed holofield save (the second roll stands). This effect only works against attack craft, and markers that behave only as fighters are still ignored normally. Due to their extremely small size and crew complement, Shadowhunters cannot initiate boarding actions. A ship that successfully boards a Shadowhunter gains a +1 modifier in addition to any other modifiers. All hit and run attacks against Shadowhunters add +1 to their roll.

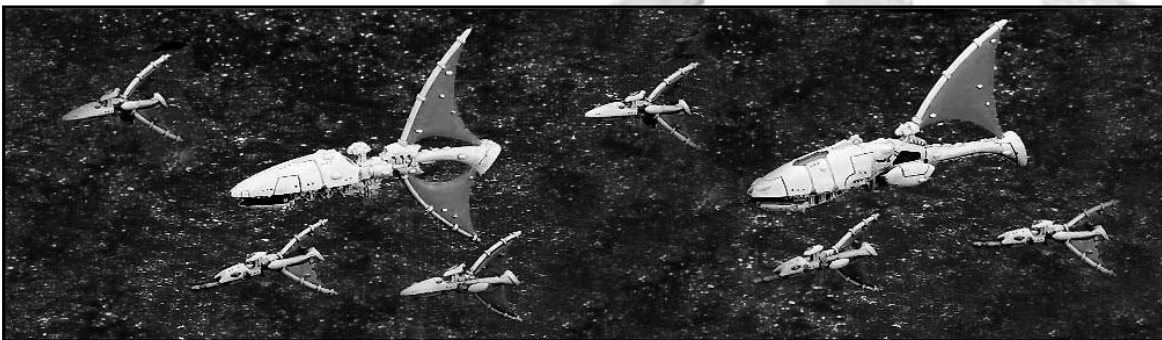

Shadowhunters are the smallest type of vessel employed by Iyanden, operating in vast shoals which shimmer and weave a short distance above the craftworld's surface as it ploughs through space. These Shadowhunter packs function as a constant patrol, guarding the approach of friendly vessels coming into dock, or spinning and bobbing around the craftworld with horrifying speed to drive off would-be attackers at a proximity where larger vessels would find it difficult to function effectively. Because of this defensive role, Shadowhunters have a very limited range, designed as they are to repel attackers which manage to actually approach the craftworld itself. Weapons and power systems on the Shadowhunters are correspondingly compact, making the Shadowhunter one of the nimblest and most agile of vessels, even by Eldar standards. Shadowhunters are so nimble, in fact, that they are capable of pursuing their enemy so closely that even enemy attack craft find it hard to evade them. During the Tyranid invasion of Iyanden, Shadowhunters typically formed a last line of defense close to the craftworld, while the larger vessels broke down the main Tyranid waves in deep space. The scattered remnants of these waves which were able to pass the Eldar cruisers and approach the craftworld were then easy pickings for the nimble Shadowhunters. As more and more waves of Tyranids descended on the craftworld, however, the Eldar fleet was overwhelmed by sheer weight of numbers, forcing the Shadowhunters to disperse and join their larger counterparts in fighting desperate counteractions in the depths of space.

Ask not the Eldar a question, for they will give you three answers, all of which are true and terrifying to know.
– Inquisitor Czevak

CRAFTWORLD ELДАР GHOSTSHIP Points: Varies

Gather the dead for war, let them join our ranks, lest we are forced to join theirs.

- Farseer Kelmon
before the defense of Iyanden

Ghostships are those vessels which, through the long slow dying-years of the Eldar race, have reached the point of near-abandonment through loss of crew. Into these vessels the Seers of Iyanden incorporate spirit stones – sacred reliquaries bearing the souls of those Eldar already lost in the struggle for survival. Sometimes Ghostships will be entirely without living crew, perhaps even imbued with the spirit stones of their original pilots, gunners and navigators, continuing to guide their race through the stars even beyond death. Sometimes the Ghostships will bear spirit stones of much older Eldar, some perhaps even with memories of the Fall, unceremoniously denied peace by the desperate hardship their people still face. For the living crew of Ghostships, the presence of these ineffable ancestor-souls creates an equally daunting and empowering burden of expectation.

These spirit stones bring sentience to the living, but otherwise unthinking, wraithbone from which all Eldar vessels are constructed – a curious amalgam of the living, the inanimate and the undying. The spirit stones allow the Ghostships to function with an impossibly tiny number of crew and, when combined with the living wraithbone of their vessels, make Ghostships exceptionally resilient. Their formless thoughts are far harder to destroy than the frail bodies of living pilots, able to simply flit from one transient vein to another. They are at complete freedom within these wraithbone skeletons, diverting both reliance and function to almost any location on the ship should any given system become damaged. But the reliance which the Eldar of Iyanden have to come to place upon Ghostships is not without difficulty. Spirit stones are already ancient and possess the temper of souls that should already be at rest, seemingly winsome and vacant, distant and

unresponsive if left to simply wander the infinity circuits away from the will of the living Eldar Seers who bind and direct them in unlife.

In order to function, a Ghostship must always be commanded by a Spiritseer – a powerful Eldar psyker who has chosen to dedicate his powers to communing with the dead. Spiritseers are some of the loneliest and most sinister members of a craftworld, required, as they frequently are, to spend periods of time alone aboard Ghostships, surrounded by nothing more than the souls of the reluctant dead.

USING GHOSTSHIPS

Ghostships do not represent a particular class of vessel, but rather they are those vessels which are substantially controlled by spirit stones, having only a small or even non-existent living crew. The use of Ghostships is strongly disliked by the Eldar, since it requires disturbing the spirits of the dead and forcing them to return once more to battle that they might aid their living kin. It is for this reason that the vessels are known as Ghostships, representing an undeniably powerful entity which straddles the boundary between life and death, yet equally represents a force that the Eldar would be wise to leave undisturbed in all but the most dire of circumstances. The Tyranid invasion and the ensuing decimation of the population make Ghostships an abhorrent necessity to the Eldar of Iyanden, however, and they are a far more common component of the Craftworld's fleets than the Eldar would wish.

Any vessel in an Iyanden fleet may be converted to a Ghostship. Ghostships use the following special rules:

Leadership: Ghostships have normal Eldar leadership.

Special Orders: Ghostships are able go onto special orders and use re-rolls in just the same manner as other vessels, however there is always a danger that the spectral and deathly manner in which these vessels interact with the real universe will distract

them and turn their attention away from the battle at hand. If a Ghostship fails a Command check for a special order, it not only fails to go onto the special order, but may also do nothing except move this turn. If the failed check is as a result of attempting to go onto Brace for Impact orders at another point during the turn, the Ghostship may still attempt to Brace for Impact but may do nothing except move during its next turn instead. When you fail a Command check for a Ghostship you may not make any further Command checks for other Ghostships during the same turn. You may, however, continue to give special orders to other 'crewed' vessels in the fleet (until, of course, you fail a Command check with one of them as well).

Deathless: Ghostships require none of the more delicate systems required to support a living crew, and the ease with which the interred spirits move throughout the wraithbone arteries of the vessel means that even when badly damaged the vessel is still able to function effectively. By the normal fragile standards of the Eldar, Ghostships present a fairly sturdy proposition. Ghostships, unlike other Eldar vessels, only suffer a critical hit on a roll of a 6 (not a 4, 5 or 6 as is usually the case with Eldar vessels).

Uncrewed: Since Ghostships are piloted by the spirits of long-dead Eldar warriors, their crews are either small or non-existent. For this reason:

- Ghostships may not contain Aspect Warrior fighting crews.
- Ghostships may not be armed with launch bays.
- Ghostships may not initiate boarding actions or hit-and-run attacks of any form.
- Enemy boarding a Ghostship gain a +1 modifier in the boarding action, in addition to other modifiers.
- Enemy making a hit-and-run attack against Ghostships add +1 to their dice roll.

Ghostships roll only half the normal number of dice when undertaking damage control in the End phase (before halving it again for Blast markers, if appropriate).

USING STARSHIPS OF THE CRAFTWORLD ELДАР

THE CRAFTWORLDS & THE OUTCASTS

The Eldar are an incredibly ancient race, who once ruled a vast empire across the stars. Then came the hideous times of the fall, when the Eldar were consumed by their own decadence and fell from power. The few who survived were scattered across the stars in their vast Craftworlds - vessels as large as worlds which now stand as the Eldar race's last remaining havens. It is impossible to say with certainty how many Craftworlds there are. They were built many millennia ago in great urgency and in times of unimaginable peril. The turmoil and confusion which preceded the destruction of the Eldar worlds was great. All higher government had long since ceased to operate, and it was only thanks to the heroic actions of a few far-sighted individuals that the Craftworlds were built at all.

THE ELДАР PATH

Aware that it was the ineffable power of their own whims and desires which had so wantonly brought about their downfall, the survivors, the Eldar of the Craftworlds, have developed a way to control their own inner natures. Every Eldar chooses for himself a discipline which he then makes it his task to master. It may take years to successfully accomplish this, perhaps more than a single human lifetime. Each discipline is rightly called a path, and each path may necessitate further choices and specialisations. For example, the Path of the Warrior has many Aspects, and whilst all enable the Eldar to master the skills of combat, each Warrior Aspect brings with it its own special techniques and abilities. Other paths include that of the Bonesinger, as the psycho-technicians who craft wraithbone and other psycho-plastic materials to fashion the material artifacts of the Eldar, or the Path of the Mariner, the calling of those that crew and eventually lead starships. There are innumerable paths, some chosen but rarely, each offering its followers a complete way of life.

OUTCASTS & THE PATH

Sometimes the rigid constraints of the Eldar path are intolerable even for an Eldar to bear; such individuals leave their Craftworlds and become known as Outcasts. Many Eldar spend years or decades as Outcasts before they return to the Eldar path. Outcasts must bear the terrible burden of their heightened Eldar consciousness without the protection of the Eldar path. Set free within the universe they are dangerously vulnerable. Only Eldar of especially strong character can survive for long as Outcasts. After years of adventure and wandering, or sailing the seas of space aboard the pirate fleets, most Eldar eventually return to the sanctuary of the Eldar path. Eldar Pirates are outcasts - Eldar who have turned away from the Path and abandoned their craftworld. These Eldritch Raiders live quite apart from the orderly, disciplined Eldar of the Craftworlds forming ravenous bands of pirates, corsairs and raiders. As with other outcasts, some of these eventually return to the Path, or may retain some ties to their original craftworld. However, the wilful and unaccountable actions of the Outcasts stand far apart from the carefully seryed and considered actions of the Craftworld Eldar, and for the most part the Farseers show great reluctance for their own peoples to mix with the wayward and dangerous Outcasts.

COMBINING CRAFTWORLD & CORSAIR VESSELS

Outright alliance between fleets acting on the will of a Craftworld's Seers and the more volatile, self-serving Eldar Corsairs is relatively rare, but certainly not unknown. It does, however, usually only occur when a knowledgeable leader of great influence is present, able to both satisfy the careful measured desires of the Seers yet at the same time prove his might to the more aggressive pirates. Such leaders, like the legendary Yriel, are rare, but the fleets they command are invariably powerful.

Ordinarily, Craftworld Eldar fleets cannot use the Reserves rules to pick ships from a Corsair fleet (nor vice versa). To use a mixed Craftworld and Corsair fleet, you must first choose to use ONE particular Eldar fleet list. In place of that fleet's normal Fleet Commander option, you must then choose an Eldar Hero. The presence of an Eldar Hero then entitles your fleet to take ships from the 'other' Eldar list (i.e. reserve Corsair ships if your fleet is a Craftworld Eldar fleet, reserve Craftworld Eldar ships if your fleet is made up of Corsairs).



'The universe is tripartite: the sunlight of the material plane, the darkness of the spirit plane, and the twilight of the spaces betwixt the two.'

- Iyanna Arienal,
Spiritseer of Iyanden

THE IYANDEN CRAFTWORLD FLEET LIST

FLEET COMMANDER

0-1 Autarch

You may include one Eldar Autarch in your fleet, who replaces the ship's Leadership with his own. If the fleet is worth over 750 points, an Autarch must be included to lead it.

Eldar Autarch (Ld 9) 75 points
 Iyanden Bearer of the Flame (Ld 10) 100 points
 The fleet commander may purchase a re-roll, at the cost listed below:
 One re-roll 25 points

Eldar Hero

Your fleet may be led by an Eldar Hero, in place of its normal fleet commander. Only a fleet led by an Eldar Hero may take reserves from the Corsair Eldar fleet list. Contrariwise, only when a Corsair Eldar fleet is led by an Eldar Hero in place of its fleet commander may it take reserves from the Craftworld Eldar fleet list.

Eldar Hero (Ld 10) 100 points
 You may purchase re-rolls for your Eldar Hero by paying the cost listed below:
 One re-roll 50 points
 Two re-rolls 75 points
 Three re-rolls 100 points

0-3 Farseers

You may include up to three Farseers in your fleet, each of whom must be assigned to a capital ship (including the flagship if desired) and gives the vessel a re-roll which may be used on itself, another capital ship in the same squadron or an escort squadron within 15cm.

0-3 Farseers +30 points

Aspect Warrior Host

Any capital ship in the fleet may be equipped with Aspect Warriors, serving as the ship's fighting crew.
 Aspect Warrior Host +20 points



CAPITAL SHIPS

Dragonships

Your fleet may include up to one Dragonship for every two Wraithships included in the fleet. If your fleet is led by an Autarch, you may include a single Dragonship as his flagship which does not count against this limitation. In order to take the Flame of Asuryan, an Eldar Hero must lead the fleet and be embarked aboard it.

(0-1) Flame of Asuryan 320 points
 Dragonship 260 points

Wraithships

Your fleet may include any number of Wraithships.
 Wraithship 160 points

Ghostships

Any capital ship in the fleet may be upgraded to a Ghostship. Such a vessel may not also include a Farseer or Aspect Warrior crew.
 Ghostship Free

ESCORTS

Your fleet may include any number of escorts, arranged in squadrons of 2 to 6 vessels.
 Shadowhunter 40 points

RESERVES AND ALLIES

An Eldar Hero must lead the fleet in order to use Corsair Eldar vessels as reserves. Following this, one Corsair Eldar cruiser or light cruiser may be taken for every three Dragonships and/or Wraithships in the fleet. Corsair Eldar escort vessels may be taken in the same ratio of no more than one for every three Shadowhunters in the fleet. These may be organized in squadrons in any mix desired, but Corsair Eldar escorts and Shadowhunters may not be in the same squadron. Up to one Void Stalker may be taken in the fleet as long as the fleet is at least 1000 points and at least three Corsair Eldar cruisers and/or light cruisers are already present in the fleet.

An Eldar Hero leading a Corsair Eldar fleet may take Craftworld Eldar vessels as reserves in the same

ratios described previously, with the Flame of Asuryan, Dragonships and Wraithships counting as cruisers. If the Flame of Asuryan is taken, the Eldar Hero must be embarked aboard it.

Prince Yriel, Bearer Of The Flame, Autarch Of Iyanden - 150 Points

Before becoming one of the most feared corsairs in all of the Imperium, he was the Autarch of Iyanden, supreme commander of its war host and battle fleet. Unlike an Exarch, an Autarch is one that has the ability to step away from the Path of the Warrior, seek out other disciplines and assume a leadership role. Despite his considerable martial prowess and tactical acumen, it was along the Path of the Mariner that he found his true calling.



Prince Yriel has at his disposal the very finest weaponry and resources available to the Iyanden Eldar. As part of his cost, he is accompanied by the fiercest members of Yriel's own pirate warband, which count as an Aspect Warrior host. His vessel is equipped with Vampire raiders as part of his point cost. He has one re-roll as part of his point cost, but a second or third re-roll must be purchased at the cost listed for Eldar Heroes.

Prince Yriel must be embarked on a Dragonship equipped with launch bays, even if he is leading a Corsair fleet. A fleet led by him has an attack rating of 4, even if it includes Craftworld vessels. He must be embarked aboard the *Flame of Asuryan* if it is present, in which case his cost is 125 points.

SCENARIO: CRAFTWORLD ASSAULT

Direct attacks against a craftworld are exceedingly rare not least because, despite their immense size, craftworlds are extremely elusive prey, rarely sighted by non-Eldar. However, when the Tyranid swarms of Hivefleet Kraken descended upon the galaxy, they did so in such numbers that Iyanden could not help but cross their path and in so doing find itself in the greatest peril of its history...

FORCES

Both fleets are of equal points. The defender (Eldar) does not spend extra points on planetary defenses – these are included in the special rules for the craftworld instead (see below). Since the attackers are Tyranids, they do not gain any extra transport models (since all Tyranid ships are ‘transports’ in effect), but if you want to replay this scenario with another attacker, they may take two free transports for every 500 points (or part) in his fleet.

Reserves: Any number of Eldar ships (including the flagship!) may be purchased against the fleet’s total at 50% cost, but they count as reserves and start off the table. Ships may not use their re-rolls if they are not yet in play. How vessels counting as reserves deploy is explained in the Craftworld special rules.

BATTLEZONE

Craftworlds will typically avoid being too close to stars but can otherwise be found just about anywhere in space. Determine the battlezone normally using a D3 for a Primary Biosphere, Outer Reaches or Deep Space result. Determine the sunward edge and set up celestial phenomena normally or in any mutually agreed-upon fashion, ignoring any outcome that results in a planet.



THE CRAFTWORLD

In this scenario, the craftworld is considered to be the target of an attack, in the same manner as a planet would be in a planetary assault. The Tyranid assault of Hive Fleet *Kraken* targetted Iyanden, which is a very large craftworld (about 25cm in diameter). However, if you are refighting this scenario with another craftworld as the target, or if you want to introduce some degree of randomness into the game, you can always vary the size of the craftworld, or roll on a dice: 1 = small (no more than 15cm), 2-5 = medium (no more than 20cm), 6 = large (no more than 30cm). Craftworlds follow all the rules for planets, since their immense size means they create their own gravity wells, etc. However, they do not roll for moons, rings, etc.

Small craftworlds have a gravity well of 10cm, medium craftworlds of 15cm and large craftworlds of 20cm. The craftworld is placed no more than 150cm from one of the short

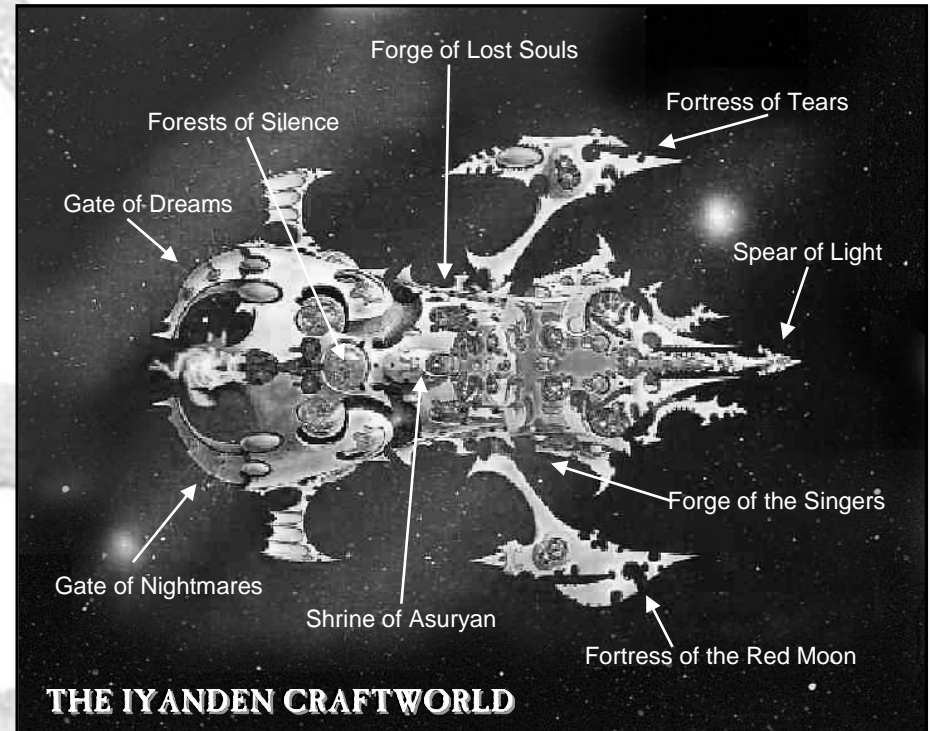

table edges. Whilst craftworlds do actually travel through space, their progress is so remarkably slow that during the course of a battle they will exhibit no noticeable movement, and hence the template representing the Craftworld itself does not move, in just the same way as planets do not move during a battle, despite their actual movement in orbit of the nearest star. Instead of planetary defenses in the normal sense, individual areas of the Craftworld are purpose-constructed to provide for its collective defense. In the particular case of Iyanden, these roles are fulfilled by three areas – the Spear of Light, the Fortress of Tears, and the Fortress of the Red Moon. Whilst other craftworlds may vary in their defenses, you can safely use the following rules as standard for all craftworlds.

Fortress of Tears & Fortress of the Red Moon

Both these fortresses are designed to repel invaders from Iyanden, utilizing powerful but indirect plasma shots to disrupt and scatter any enemy which manage to evade the craftworld’s cruiser patrols. At full effect the fortresses are designed to act as the defenses for the entire eastern and western halves of the craftworld respectively. Each time an Assault Point is scored (or ‘landed’ on the Craftworld), roll a dice. On a score of a 4 or more, one of

the fortresses damages the attacking wave so heavily that the landing is essentially ineffective and no Assault Point is scored.

The fortresses also allow the craftworld to repel ships in low orbit. During the Eldar player's Shooting phase, the two fortresses each unleash one 45cm pulsar lance against each vessel on the Low Orbit table, for a total of two per enemy vessel. These cannot be redirected or "stacked" on a single or group of targets, each enemy vessel can receive no more than two pulsar lance shots that roll to hit in the normal manner pulsar lances work.

There is always the danger that the fortresses themselves will fall. During each End phase, roll one dice for each Assault Point already scored on the craftworld. If any of these score a '6' one of the fortresses are damaged, and the chance of destroying enemy Assault Points, or scoring a hit on ships in low orbit, is reduced by 1 (ie, to a 5+ the first time, then to a 6+, then they are destroyed completely). This also reduces the number of pulsar lances that can be fired at each enemy vessel by 1. No matter how many 6's are rolled, only a single -1 reduction can apply in each End phase.

The fortresses also allow the craftworld to repel ships in low orbit. During the Eldar player's Shooting phase, the fortresses each unleash one pulsar lance against each vessel on the Low Orbit table. However, there is always the danger that the fortresses themselves will fall. During each End phase, roll one dice for each Assault Point already scored on the craftworld. If any of these score a '6' the fortresses are damaged, and the chance of destroying enemy Assault Points, or scoring a hit on ships in low orbit, is reduced by 1 (ie, to a 5+ the first time,



then to a 6+, then they are destroyed completely). No matter how many 6s are rolled, only a single -1 reduction can apply in each End phase.

Spear of Light

While the Spear of Light is essentially another heavily armed redoubt constructed for the defense of the entire Craftworld, it is most renowned for the *Spear of Light*, a titanic linear accelerator bearing its name and capable of hurling plasma charges at nearly the speed of light. Its primary purpose is to eliminate dangerous objects in its path, such as recalcitrant moonlets! However, when the defense of the Craftworld is at stake, it can be re-purposed as a weapon with poor accuracy by Eldar standards but horrifying destructive power. The *Spear of Light* functions as a single Nova Cannon in all respects. Like the fortresses, one dice must be rolled during each End Phase for each Assault Point already scored on the craftworld. If any of these score a '6' the Spear of Light is damaged, and a Reload Ordnance special order must be passed each time the weapon is used again. If a '6' is rolled again in a subsequent End Phase, the Spear of Light is considered destroyed for the rest of the battle. The Spear of Light is used against targets at range and has no effect against vessels on the Low Orbit table.

Forge of the Singers and Forge of Lost Souls

A craftworld's Bonesingers have at their disposal the means to construct and service an entire Battlefleet of Eldar vessels. Indeed, their construction and fabrication techniques are so efficient, they can quite literally have at their disposal more starships than there are Eldar crew to man them. While even this prodigious capacity serves little utility in the heat of battle, it can in an emergency aid a vessel in dire straits. Any Eldar capital ship in low orbit can dock with the Craftworld by "landing" on the surface without requiring a leadership check. Unlike when coming in contact with a planet's surface, the vessel does not count as destroyed by doing so, though it must subsequently remain in place for one full turn. It gains +4D6 to repair critical damage in the End Phase and may regain up to 1Hp damage for every roll of 6 not used to repair critical damage (all critical damage must be repaired before this benefit can be taken). Additionally, it counts as passing a Reload Ordnance special order for free. However, it may not move, shoot or launch ordnance while docked, critical damage that cannot normally be repaired during a battle (such as holofields damaged) still remains damaged, and while docked to the Craftworld the ship counts as defenses for purposes of being fired upon using the gunnery table. Holofields work normally against gunnery-based weapons, and the ship benefits from an additional right column shift and may ignore blast markers while docked, as it is inside the sheath of the craftworld's powerful polarization field.

Gate of Dreams and Gate of Nightmares

Like virtually all craftworlds, Iyanden has a series of webway portals scattered throughout its structure. The two largest of these are the Gate of Dreams and the Gate of Nightmares. Each one of these is capable of opening vast portals sizable enough for even the largest of the Eldar's war machines. Together, they create a single portal at the rear of the Craftworld large enough for traversing starships. Beginning turn 2, after the Eldar fleet moves roll a D6. On a 5+, D3 capital ships and/or escort squadrons of the owning player's choice held in reserve at the start of the game now appear along the table edge closest to the Craftworld no more than 30cm away from it. Eldar ships cannot move in the same turn they appear.

SET-UP

The Craftworld template is placed on the table in the same manner as a planet using the Planetary assault rules on p.76 of the Rulebook. The defender can choose to place ships and squadrons either on patrol or on standby in high orbit, or within the craftworld's gravity (low orbit table). Roll a D6 for each defending ship/squadron (except Shadowhunters) on patrol: on a 1-3 the attacker may set up the ship/squadron, on a 4-6 the defender may set it up.

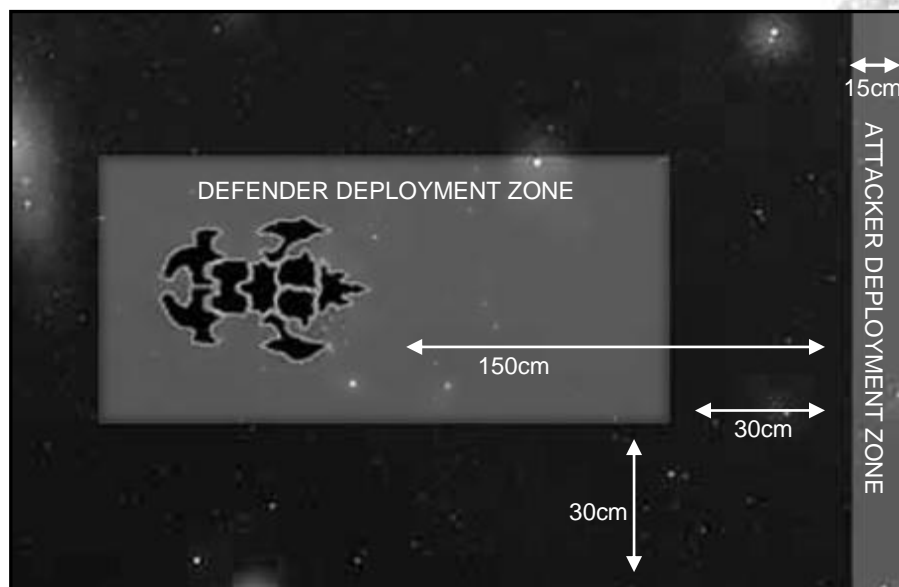

Ships on patrol may be set up anywhere that is not within 30cm of a table edge or within an area of celestial phenomena. The defender always decides the facing of ships, regardless of who set them up. The attacker deploys his fleet within 15cm of the short table edge furthest from the planet. You will also need a separate low orbit table.

Shadowhunter Patrols

Shadowhunters are quite simply the most nimble patrol vessels in the galaxy, and so must always be set-up on patrol, but no dice roll is required, and they are always deployed by the defender.

FIRST TURN

The players roll a D6, with each player adding their fleet's initiative (attack rating) to the roll. Whoever got the highest may take either the first or second turn.

SPECIAL RULES

The rules for this scenario are as described on p.74 of the Battlefleet Gothic Rulebook. In addition, at the beginning of each defending player's turn after the first turn, the defending player rolls 2D6 against the following table. Unless otherwise stated, special orders called for by this table are assumed to have automatically passed and must be taken for that turn.

GAME LENGTH

The game lasts until one fleet is destroyed or disengages, or the attacker has scored 10 or more Assault Points.

VICTORY CONDITIONS

Add up the Assault Points earned by the attacker and add +1 to the total for every 500 Victory Points (rounding down) scored by the attacker for destroying or crippling ships and planetary defenses. Deduct -1 Assault Point for every 500 Victory Points (rounding up) scored by the defender. Look up the adjusted Assault Point total on the table below:

| ASSAULT POINTS | VICTORY RESULT |
|----------------|--------------------------------------|
| 0-1 | Defender's Major Victory (+1 Renown) |
| 2-5 | Defender's Marginal Win |
| 6-9 | Attacker's Marginal Win |
| 10+ | Attacker's Major Victory (+1 Renown) |



DOMAINS OF THE ELДАР

For millions of years after the disappearance of the Old Ones, the Eldar as the oldest of the Young Races built a galaxy-spanning empire long before humans had even mastered fire. Their command of the galaxy and the Webway that gave them access to it filled them with an arrogant belief that there was nothing they couldn't overcome. Over time their exploration of all without and within led to ever more extreme and perverse pleasures, eventually resulting in the Fall and their near-extirmination in the 30th Millennium as the Chaos god Slannesh was born. As the Warp tore into real space and much of the Webway was shattered, only the vast Craftworlds that fled before the Fall and the many Eldar Havens that served as island harbors among the vast sea of stars survived the ensuing holocaust.

Scattered across the galaxy, Havens were only designed to be way stations serving as frontier ports for repair and re-supply as the Eldar traveled through the Webway across their unimaginably vast domain. Though heavily armed and stoutly constructed in memory of the titanic wars that gripped the galaxy in the Eldar race's youth, their best defense was their stealth, and jealously guarded were the secrets of their locations. A vast number of these were left cut off and isolated with nothing but the meager fleets

that happened to be nearby during that great cataclysm, and many of these stations resorted to piracy to maintain their existence. Most faded away in an unforgiving universe as they were systematically discovered and destroyed by other races, especially by the krork and the upstart monkeigh as they expanded their influence in the galaxy, filling the void left by the Eldar's demise. A precious few however still remain the island havens they always were, situated near a Webway portal in deep space or near an Exodite World as a remote outpost for one of the few vast Craftworlds that still ply the stellar main.

Other Havens survive as undiscovered pirate bases populated by corsair bands and outcasts, most infamously the never-revealed pirate base of Prince Yriel's Eldritch Raiders after his forces defeated and combined with those of the notorious corsair Shadow Price Xian. These pirate redoubts are keenly sought after by the Imperium, but at worst they are little more than bastions for the outcasts that prey on targets of opportunity for little more than to meet their own selfish ends. Of far greater danger to the galaxy at large are those perverted citadels of the Dark Eldar, the Eldar's *Druchii* kin, ancient pirate renegades descended to the very depths of depravity

with no act of unmitigated malice too evil for their doing. Rather than merely subsist on piracy, they actively seek out the terror and wanton murder that such activities bring, and even the Eldar corsairs steer clear of these malevolent caitiffs unless battle is inevitable.

ELДАР HAVEN SPECIAL RULES

An Eldar Haven rolls for leadership following Eldar rules and can attempt Special Orders as ships do, though it may only attempt to Lock On, Reload Ordnance or Brace For Impact. An Eldar or Dark Eldar fleet commander can lead the battle aboard it instead of a ship. Eldar Havens are more solidly built than their agile but relatively delicate starships. They are armor 5+ and take critical damage on a 5+ instead of 4+ like Eldar vessels. They also have much larger power reserves than Eldar vessels do, and their weapons have significantly longer range. As with Eldar vessels, Eldar Haven weapon batteries always count as closing.

An Eldar Haven may be used as a Dark Eldar pirate base. When used as such, trade bombers for assault boats and Pulsar Lances for Shadow Lances at no change in cost. All other characteristics remain unchanged.

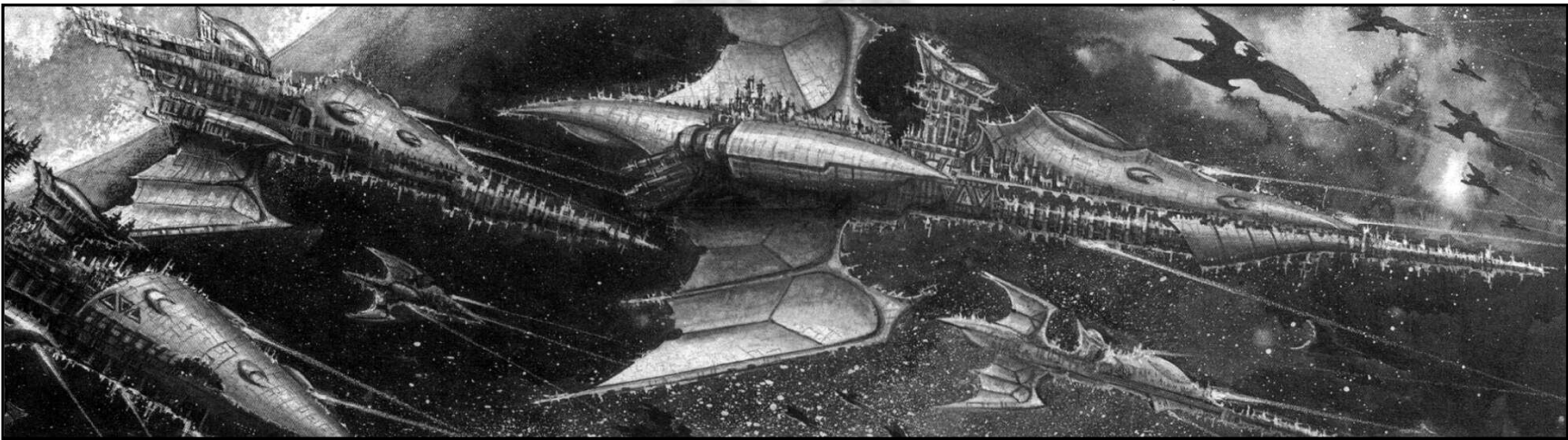

An Eldar Haven, even more so than other clandestine redoubts, relies more on its ability to remain hidden than any capacity to repulse a sustained assault. To this end these way-stations are normally situated in the outer dark, and they will never be anywhere closer in-system than the Primary Biosphere. These ancient keeps are fitted with the very pinnacle of Eldar technology, systems only rarely made available to the already wraithlike vessels of this enigmatic race.

Netherfield: A refined holofield design coupled with an absorptive masking layer make the Haven nearly impossible to target. On the Haven it imparts an additional column shift for all weapons that use the gunnery table.

Polarization Field: A low-level energy bubble surrounds the Haven, channeling the debris of space around the station. While not a propulsion system per-se, it allows the Haven to maintain its position in the vicinity of celestial phenomena to a fine degree. It does risk suffering a hit for being in contact with blast markers and ignores all effects of solar flares.

Like other large defenses, the Eldar Haven removes D6 blast markers in base contact at the end of each turn separately from the D6 blast markers removed from play normally.

Due to the Eldar's superior maneuverability, Eldar ships can dock with a Haven using a simple leadership check and do not need to be on special orders to do so. Any of the owning player's capital ships that dock with the station for one full turn gain +2D6 to repair critical damage in the end phase and are considered to have reloaded ordnance for free. Ships doing so cannot move, shoot or launch ordnance in that turn, though holofields continue to work normally, and they can attempt Special Orders if desired. The Haven may reserve its extra +2D6 capability to repair critical damage for itself if there are no ships docked to the station any time during the turn.

Webway Portal: Many Eldar Havens are situated in deep space or near one of the Exodite Worlds, usually near a Webway Portal large enough for starships to traverse. The owning player may use the Webway to summon additional warships to its aid. Any number of ships may be purchased against the fleet's total at 50% cost, but they count as reserves and start off the table. Beginning turn 2, after the Eldar fleet moves roll a D6. On a 5+, one capital ship or escort squadron appears along the table edge closest to the Eldar Haven. Eldar ships cannot move in the same turn they appear.

In a campaign, a player counts as having a pirate base for purposes of repair points for every Eldar Haven on the player's fleet list. Its value counts against the fleet list in individual battles in which it

takes part, but it does not count toward the starting point limit a fleet has, as it remains hidden at the start of the campaign and can only be attacked if the opposing player discovers it. An Eldar fleet may start a campaign with one, but may only earn up to two more in the course of a campaign by an Eldar commander with eleven or more renown by expending a dedicated appeal, needing a roll of 5+ to succeed. Should an Eldar Haven be revealed and come under attack, the owning player can attempt to retreat the station back into the Webway to prevent further attacks on it. To do so, the owner must roll a D6. On a roll of 1 it is lost in the Webway and must be struck from the roster. On a 2+, the Haven has been re-situated successfully and must once again be located by an opponent before it can be attacked.

ELDAR HAVEN CRITICAL DAMAGE TABLE

| 2D6 | EXTRA DAMAGE | RESULT |
|-----|--------------|---|
| 2 | +0 | Infinity Circuit Damaged. The station's Infinity Circuit aiding control and internal communications is hit. Leadership is reduced by -1 until repaired. |
| 3 | +0 | Weapon Batteries Off-line. The weapon battery targeting node arrays are damaged. Weapon batteries may not fire in any arc until repaired. |
| 4 | +0 | Pulsar Lances Off-line. Power couplings to the lance crystals are hit. Pulsar Lances may not fire in any arc until repaired. |
| 5 | +0 | Launch Bays Damaged. Explosions rock the ordnance bays. Ordnance may not be launched until repaired. |
| 6 | +0 | Mainsails Scarred. The main solar sails suffer surface damage. All weapon systems are reduced to 50% effectiveness until repaired. |
| 7 | +1 | Superstructure Damaged. The hit tears into the station, causing a small breach. Until the damage is repaired, roll a D6 at the beginning of each turn. On a roll of 1, the station takes an additional hit. |
| 8 | +0 | Polarization Field Off-Line. The station loses ability to maintain position in space. Until repaired, the station drifts 5cm toward the nearest celestial phenomena and loses the ability to ignore blast marker or solar phenomena effects. |
| 9 | +1 | Infinity Circuit Smashed. The fine crystal matrix of the station's Infinity Circuit is shattered, reducing leadership by -3. This damage may not be repaired. |
| 10 | +0 | Holofield Generators Destroyed. Smashed beyond repair, the station no longer benefits from its holofields. This damage also affects its Netherfield and may not be repaired. |
| 11 | +D3 | Hull Breach. A huge gash is torn into the station's hull, causing carnage among the crew. |
| 12 | +D6 | Bulkhead Collapse. Internal pillars buckle and twist as whole compartments crumple and twist with a scream of tortured wraithbone. |

ELDAR HAVEN SPACE STATION 200 Points

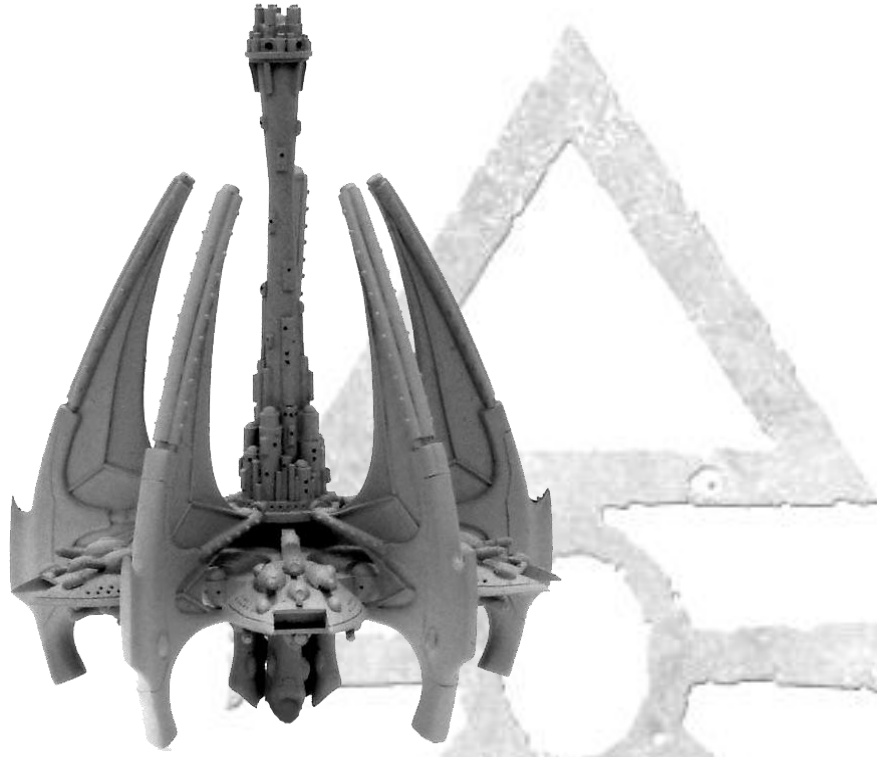

Haven Spires are the most elusive of outposts, existing in remote regions of space, moored near a lonely webway portal far from a nearby star. However, it is not unknown for these stations to be concealed near celestial phenomena in the outer reaches of systems frequented by other races oblivious to the threat hiding in their midst. Stories exist of the Biel-Tan Haven Rash Niaeae standing silent watch over the seemingly abandoned forest world of Cyclonea, only to awaken as the bastion of a mighty Swordwind host at the presence of Ork invaders or a human exploratory fleet. Several have become shrouded in darkness as domains of the Dark Eldar. Any unfortunate soul finding itself brought prisoner within the twisted spires of such a damned place is assured only a demise filled with agonies the likes of which cannot be imagined in one's worst nightmares.

As often as not, Eldar Haven Spires will have a small contingent of warships detached to it. It is believed that the An-Iolsus and Ulthwé Craftworlds in particular have several of these stations scattered throughout the sectors surrounding the Eye Of Terror, and these stations may also explain how the Dark Eldar have managed to conduct their piratical raids throughout much of the known galaxy.

| TYPE /HITS | SPEED | TURNS | SHIELDS | ARMOR | TURRETS |
|-----------------|-----------------------------|--------------------|-------------|------------|---------|
| Defense/8 | None | None | Holo-fields | 5+ | 0 |
| ARMAMENT | RANGE | FIREPOWER/STRENGTH | | FIRE ARC | |
| Weapons Battery | 60cm | 8 | | All Around | |
| Launch Bay | Darkstar 30cm Eagle 20cm | 5 squadrons | | N/A | |
| Pulsar Lances | 45cm | 3 | | All Around | |

Notes: As part of its cost, the Eldar Haven is equipped with a Netherfield, a refined holo-field design coupled with an absorptive masking layer make the Haven nearly impossible to target. It imparts an additional column shift (in addition to holo-fields) for all weapons that use the gunnery table. It is also equipped with a Polarization Field; a low-level energy bubble surrounds the Haven, channeling the debris of space around the station. It does not risk suffering a hit for being in contact with blast markers and ignores all effects of solar flares.

"Your kind think you are so magnificent, yet even now, at the nadir of our power, we can manipulate you, turn you to our ends, as easily as you might pull a trigger and fire a gun. Our time will come again, Eldrad has promised us. Once more you upstart mon-keigh shall kneel before our power! This time we will not be so lenient! We will exterminate you, every world, every vessel, every one of you! Eldrad has seen the stars stained red with your blood, and it pleases him!

You think us weak, but we will be your doom, children of Earth."

- From interrogation of captured Eldar Ranger

ELDAR TRANSPORT Special



Eldar Craftworlds are largely self-sufficient, and travel through the Webway obviates the need for a large fleet of dedicated transport vessels. However, such conveyance is nonetheless required for quickly transiting supplies and personnel to Eldar Haven Spires, and occasionally to contested worlds without ready access to a webway portal of sufficient size.

While it is exceedingly rare that the Eldar would stoop toward open trade with the mon-keigh besides the occasional Rogue Trader, it is not too uncommon for them to use these vessels to effect trade with other, more august races, or with those they determine would be advantageous to their own mysterious ends.

Occasionally, small groups of these vessels will ply the stellar main under escort by a contingent of warships, though like everything else about the Eldar, these are usually for reasons much more inscrutable than appearances may indicate. Nonetheless, they are not immune to the predations of the galaxy, and the Dark Eldar in particular consider such vessels a particularly battle-worthy prize.

| TYPE /HITS | SPEED | TURNS | SHIELDS | ARMOR | TURRETS |
|-----------------|------------|---------|--------------------|-------|----------|
| Escort/1 | 10/10/15cm | Special | Holofields | 4+ | 0 |
| ARMAMENT | | RANGE | FIREPOWER/STRENGTH | | FIRE ARC |
| Weapons Battery | | 30cm | 1 | | Front |

Notes: Though Eldar transports are like their other starships in that they are crewed by those who have elected the Path of the Mariner, these ships are generally led by Craftmasters that are less experienced than those who pilot true warships and thus suffer -1 modifier against the Eldar leadership table. Eldar transports are reserved for scenarios that require transports, for which they have the value of a full transport or two assault points.

ELDAR CREW SKILLS TABLE

Over the course of a campaign, a ship's crew develops experience that only comes from serving together in the crucible of war. Roll a D6 against the following table:

D6 Crew Skill

- Expert Gunnery.** The ship's gun crews are amongst the finest in the whole sector, able to lay down a devastating barrage. When the ship attempts to make Lock-On Special Orders, you may roll 3D6 and discard the highest D6 before comparing the roll against the ship's leadership.
- Warlock.** A renowned Seer accompanies the vessel, disclosing fragments of possibility to the ship's captain. This vessel may always attempt to go on Special Orders, even if another ship or squadron in the fleet has failed a command check this turn.
- Excellent Pilots.** Even the bomber pilots assigned to this ship number several 'Aces' amongst its crew. Bombers launched by this vessel may survive being intercepted by enemy fighters utilizing the 'Resilient Attack Craft' 4+ save rule in the same manner as Eldar fighters. As they are not fighters themselves, they still ignore other types of ordnance normally. Fighters from this vessel are *always* moved before enemy attack craft in the ordnance phase. Re-roll this result if the ship does not carry attack craft.
- Battle Stance.** Aspect Warriors, Dark Eldar Wyches or even the dreaded Harlequins have been enticed to join your vessel. This ship may re-roll the dice in a boarding action. The second roll stands (even if less!). This benefit can be combined with having an embarked Aspect Warrior Host.
- Disciplined Crew.** Whenever this ship checks leadership or attempts to go on Special Orders, you may roll 3D6 and discard the highest D6 before comparing the roll against the ship's leadership.
- Elite Command Crew.** Once per battle the ship may automatically pass a Leadership test or command check – there is no need to roll any dice. This may be used even if another ship or squadron in the fleet has failed a command check this turn.

This crew skills table is for use by the Haven, any capital ships or escort squadrons in a Corsair Eldar, Craftworld Eldar or Dark Eldar fleet. The refit table on the next page is for use by any capital ships in a Corsair Eldar, Craftworld Eldar or Dark Eldar fleet. It is not for use by escorts. Eldar Havens may earn ship or weapon refits but not engine refits. Ships that cannot use the refit or crew skill rolled for whatever reason may re-roll the result, such as not being equipped with weapon batteries, attack craft, etc.

ELDAR REFITS TABLES

The ship's engines are fitted with additional systems, or improvements have been made to the power generators and energy relays in some fashion. Roll a D6 against the following table:

D6 Engine Refit

- 1 **Celestial Dragon Engine.** The standard maneuvering thrusters have been augmented, allowing breathtaking turns. The vessel may choose to turn up to 90° at the *end* of its movement instead of turning normally at the beginning of its movement. Not for Dark Eldar – roll again.
- 2 **Polarization Field.** A low-level energy bubble surrounds the ship, channeling the debris of space around the vessel. The ship does not suffer a hit for moving through blast markers and ignores all effects of solar flares.
- 3 **Drunken Weave.** An intricate system of particle flow rudders and graviton impellers are fitted to the vessel, allowing for drastic evasive maneuvers. The ship gains a 6+ save on a D6 against any damage it takes without requiring a Command Check. This does *not* count as being braced, but the ship may *not* use this save when on Brace For Impact Special Orders or attempt to go on Brace For Impact special orders against any round of shooting or event of taking damage if this save fails.
- 4 **Phoenix Sails.** Hyper-efficient materials of exceeding purity are used to replace the mainsails, squeezing extra energy from the solar wind, adding +5cm to all speed bands. Dark Eldar vessels add an additional +1D6cm speed when on All Ahead Full special orders.
- 5 **Moon Gossamer Rigging.** A Bonesinger has spent many hours re-splicing the ship's control mechanisms. Instead of turning to any facing at the start of its movement, it may choose to make a single 45° turn at any point along its movement. Not for Dark Eldar – roll again.
- 6 **Stream Flow Enhancers.** A dramatic re-rig of the ship's sails and control surfaces give the captain much greater control over his or her vessel. When the ship is facing the sun, it counts as having the sunward edge in its rear. If the sun is in the rear arc, it counts as on its side. Dark Eldar vessels add +5cm to their speed.

The structure of the ship is improved in some way, new equipment is installed, or specialized crew members are brought aboard. Roll a D6 against the following table:

D6 Ship Refit

- 1 **Crystal Web.** A sizable colony of crystal spiders have been introduced to the hull, greatly enhancing the ship's chances of survival. If the ship has no critical damage, roll a number of D6 equal to the number of hits it has remaining, recovering 1HP if any rolls of 6 are made. No more than 1HP can be regained in this manner per turn, regardless of how many rolls of 6 are made.
- 2 **Bonesinger.** A much-respected Bonesinger has joined the ranks of the crew. The ship only suffers critical damage on a 5+ instead of a 4+. Not for Dark Eldar – roll again.
- 3 **Mask of the Laughing God.** Special psychic dampers and cross-spectrum jammers hide the intentions of the crew. Enemy vessels do not gain +1 Leadership for this vessel going under Special Orders.
- 4 **Gestalt Spirit Stone.** The ship is incredibly ancient, even by Eldar standards, and its spirit has literally eons of experience. The vessel ignores all penalties to leadership tests, such as blast markers, Marks of Chaos, etc.
- 5 **Netherfield.** A refined holofield design coupled with an absorptive masking layer make this ship nearly impossible to target. It grants an additional right column shift to the vessel against all weapons that use the gunnery table (no additional modifier is granted past the far right of the gunnery table).
- 6 **Structural Purity.** The cores of the ship's wraithbone supports are partially replaced by a fluidic medium that dissipates damage throughout the hull. Before the battle begins, the vessel gains +1HP to its starting damage capacity.

The ship has been upgraded with additional or more sophisticated weapon systems, greatly enhancing its battle effectiveness. Roll a D6 against the following table:

D6 Ship Refit

- 1 **Talons.** Both the outer hull and the ship's airlocks are lined with psychically charged scatter-shard point defenses. Enemy ships attempting to board the vessel or perform a hit-and run attack suffer a -2 modifier.
- 2 **Distortion Charges.** The vessel has been fitted with a weapon system which ejects a Warp Distortion charge into its wake (useable once per game). This D-charge must be placed at the same time the player places the rest of the fleet's ordnance on the table, in the ship's aft firing arc. When launched, it moves 10cm toward the nearest enemy vessel every ordnance phase. If it comes in contact with an enemy ship's base, the enemy vessel may attempt to shoot it down with turrets, hitting on a roll of 6. If the D-charge is not destroyed, place a warp rift marker at the point of impact using a Nova Cannon template. Any vessel touching the template suffers the effects of coming in contact with a warp rift! At the beginning of each subsequent Eldar turn roll a D6. On a roll of 6 the rift closes and is removed from play.
- 3 **Rune-Assisted Targeting Nodes.** The fire control systems are linked by a complex sensor array. Ships fitted with lance-type weapons may re-roll their first miss each turn.
- 4 **Gravitic Accelerators.** An extra boost is provided to torpedoes and attack craft. When first launched, ordnance receives an extra +10cm to its movement.
- 5 **Anomaly Clarification Stones.** The ship's scanners are able to compensate for local spatial distortions. Blast markers do not cause a column shift when the ship's weapon batteries fire through them.
- 6 **Enhanced Crystal Focusing.** Rare ultra-pure crystals and a delicate realignment of the firing mechanisms raise the power transfer ratio of the ship's weapons, significantly increasing their range. Add +15cm range to the ship's weapon batteries and lance-type weapons.

ENGINE REFIT

SHIP REFIT

WEAPONS REFIT

‘ERE WE GO! ‘ERE WE GO! ‘ERE WE GO!

ORK CLANZ IN BATTLEFLEET GOTHIC



Orks are not the greatest space-faring race in the galaxy. Their ships are often ill-kempt, unreliable rust buckets kept in operation only by the constant efforts of Ork Mekboyz and their Gretchin slaves. They make great use of salvaged hulks and their largest vessels are often refitted space hulks that providentially drift out of the Warp near one of their worlds. Ork pirate attacks are brutally direct, with their ships rushing headlong towards their target, guns firing wildly as they come. Unfortunately Ork ships are exceedingly heavily armed for their size, so this tactic is harder to defeat than might be imagined.

Orks gather into various levels of organization. The first is the mob, a squad-level unit of Orks with similar ideas of how to act on the battlefield, generally led by a nob (short for "noble," but pronounced "knob"). A number of mobs will gather together into a warband, which is roughly equivalent to an Imperial Guard company (although with a greater variation in size and strength), led by a warboss. The largest Ork organizational unit is the tribe, a group of numerous warbands all under the command of a

warboss. Different tribes can be united by a powerful warlord when he raises a Waaagh!

As opposed to the warbands and tribes that Orks naturally organize in, Ork clanz are not communities but rather philosophical delineations of the different varieties of Ork. Each has its own colors, markings, and ways of waging war. Orks tend to form warbands with others who follow the same clan, but different groups or even so-minded entire warbands will tend to conglomerate together after suffering casualties during a Waaagh! It is not unheard of for an especially influential

ORK SPECIAL RULES

LEADERSHIP

While Orks approach space combat with the same gusto they reserve for all forms of violence, the technical nature of the fighting is often at odds with their ability. This means that all Ork ships reduce their Leadership by -1 from whatever they rolled, giving them a Leadership range of 5 to 8.

MOB RULE

Big groups of Ork escorts are surprisingly coordinated. Ork escort skwadrons gain a +1 bonus to their Leadership while they contain more than five models (or 'lotz' as the Orks call it – Orks aren't very good at counting). Note the maximum number of escorts in an Ork squadron can be up to ten.

YOUNG GUNZ

While not technically skilled, Orks do possess boundless enthusiasm for fighting, and mobs of young Orks, eager to prove themselves to their elder and larger peers often pack themselves aboard rickety old escort vessels and tag along to any battle they can find. Any Ork escort skwadron with a Leadership of 5 or 6 gets a bonus escort ship added for free, demonstrating quantity has a quality all of its own. This includes is the leadership is a result of being

swapped with that of a Warboss! The free ship can be any Ork escort class in the fleet list costing equal to or less than that of the cheapest escort paid for in the skwadron (the skwadron cannot exceed ten escorts). Young Gunz can be applied before Mob Rule: a tiddla skwadron with five escorts that rolls Ld5 may have a sixth escort for free, increasing its Ld to 6!

ALL AHEAD FULL SPECIAL ORDERS

One thing Orks need very little encouragement to do is go fast. Their ships commonly mount a plethora of excess (and excessive) thrusters, boosters and extra drives – usually all wired up to a prominent red button in the cockpit. Because of this, Orks do not need to pass a Command check to use All Ahead Full special orders. However, Ork drives are less efficient than those of other races and are often short on fuel, so they only travel an extra 2D6cm on All Ahead Full

orders instead of 4D6cm.

BOARDING

Orks are ferocious close combat opponents and exceptionally good at boarding actions, where their brute strength and hardiness is most useful. To represent this, they get a +1 bonus in boarding actions.

LAUNCH CAPACITY

Some ships in an Ork fleet may possess a variable launch capacity (as is the case with many Ork capital ships). In the Ordnance phase of each Ork turn when Ork attack craft remain in play, an Ork fleet with variable launch bay Strength must roll to check its attack craft capacity. Roll the relevant dice for any vessel with variable launch bay Strength and add on to this the launch bay Strength for any ship with fixed Strengths to find the total launch capacity for the

fleet. Any excess attack craft above this total are removed at the end of the turn as they run out of fuel – use 'em or lose 'em. Torpedoes are not subject to this rule, as they have no launch limits.

ORK WEAPONS

GUNZ

Standard Ork weapons batteries are mostly limited to fairly crude but efficient slug-throwers and missiles, mixed with other captured weaponry salvaged from hulks and defeated ships. The effectiveness in battle of Ork firing varies wildly from moment to moment as different weapons break down or are repaired, or even improved during combat. These are referred to as 'gunz' and have a random firepower which is rolled each time they are fired. The dice roll and modifier for different gunz is indicated on the Ork



ship's characteristics.

HEAVY GUNZ

In addition to more standard weapons batteries, the Orks commonly mount massed batteries of very powerful but short ranged weapons on their ships. At close ranges, the barrage of fire from these weapons has spelled the doom of many enemy vessels. Heavy gunz roll to hit like ordinary weapons batteries but do not count gunnery modifiers for range. Each hit scored by heavy gunz causes double damage, meaning two hits instead of one.

TORPEDO LAUNCHAS

As with their gunz, Ork torpedo salvoes can vary wildly in their effectiveness as launchers malfunction, externally-mounted stores are discharged with wild abandon, etc. The strength of a salvo from an Ork torpedo launcha is randomly generated each time it is fired by rolling the dice indicated on its characteristics. Ork ships in skwadrons may not combine torpedoes into larger salvoes. Capital ships equipped with torpedo launchas may also take boarding torpedoes for +5 points (+15 points for a Space Hulk), which behave in the same manner as such ordnance for other races. Escorts may not use



boarding torpedoes.

FIGHTA-BOMMAS

Ork attack craft are known as Fighta-bommas and perform the roles of both interceptor and bomber. They carry heavy bombs and rockets for attacking at close range, but gladly pounce on other attack craft they encounter. This hybrid approach means that they function as fighters normally but can attack ships as if they were bombers in some circumstances. When making an attack run the Fighta-bommas function exactly as bombers, except that they roll only a D3, not a D6, for the number of attacks they inflict. Because Ork fighta-bommas behave as both bombers and fighters, they add +1 attack for each marker in the wave after attack rolls are modified by turrets, meaning each ordnance marker that survives against turrets will be able to conduct at least one attack and will not have a minimum of zero attacks.

ASSAULT BOATS

Ork assault boats behave in the same manner as such attack craft for other races.

TORPEDO-BOMMAS

Orks will sometimes strip out all point-defense weapons from their fighta-bommas to sling gigantic, ship killing weapons underneath their attack craft, all in the effort to make them more shooty. Such converted attack craft are torpedo-bommas, which lose all their maneuverability and are slowed down considerably to carry such enormous weapons. Torpedo bommas only move 20cm and have no fighter capability whatsoever. In the beginning of any turn after the turn they are launched, each torpedo-bomma marker may be converted into a str-2 torpedo salvo. Torpedo bommas in a wave may combine their salvoes into a single salvo, or any number of markers may launch their salvoes separately. Torpedo bommas may be taken by any ship equipped with launch bays for +10 points per launch bay. For ships with variable launch bays, this is calculated based on the maximum number of launch bays available, meaning the upgrade costs +40 points for 'Ammer-class battlekroozers, etc. When taken, torpedo bommas are an additional ordnance choice available to the karrier and do not replace fighta-bommas.

GUBBINS

Orks are always trying to improve their ships in some fashion and will do whatever they have to for either more parts or the teef to buy them. A warlord in particular gathers around himself a number of other cunning and successful leaders, each one an enterprising Mekboss or Nob in his own right. Several warlords may band together to fight a common foe, and they will each of course bring the best of their wargear to the fight, as much to demonstrate their prowess to their fellow warlords as to bring the fight to the enemy. A vessel or escort skwadron led by a Warlord may be given up to one of the following upgrades per Command re-roll the Warlord has. Each upgrade can only be applied once. Note: Players are actively encouraged to change their upgrades from battle to battle in typically restless Orky fashion. Each Warlord that does so at least twice over the course of a campaign may have their first normally earned refit for free instead of paying the normal +10% cost.

For tiddla skwardons, the point cost for clan upgrades count for the whole skwadron (regardless of how large it is!), not individual escorts. This also means the enemy only gets additional victory points for the clan upgrade is the tiddla skwadron is wiped out. If a single escort survives the battle, the enemy does not get additional victory points for the clan upgrade. Not all Gubbins apply to escorts or are taken the same way as capital ships, as indicated by their notes. Gubbins taken for escorts must be taken by all escorts in the skwadron (if applicable) for their listed cost and not merely by individual escorts.

Soopa Boostas +25 points
the ship gains +5cm speed, and it rolls 4D6cm when on *All Ahead Full* special orders.

Extra Power Fields +25 points
(Not for escorts) The ship's shield value is increased by +1.

Extra Turrets +20 points
The ship gains +2 Turrets (Escorts get +1 Turret).

Maniac Turrets +10 points
(Not for escorts.) The ship's turret value is replaced by D3 turrets. This cannot be combined with Extra Turrets.

Looted Lances +30 points
Any heavy gunz batteries on the ship can be replaced with a Strength 2 lance battery. Range is 15cm for escorts, 30cm for capital ships.

Looted Torpedoes +20 points
The ship may re-roll the dice for the Strength of torpedo salvos when it fires.

Mad Meks +25 points
(Not for escorts.) The ship may re-roll the dice when repairing critical damage.

Maniac Gunners +30 points
The ship may re-roll the dice for the firepower of its gunz when it fires.

Mega-Armored Boarding Parties +15 points
(Not for escorts.) The ship has an additional +1 modifier when rolling for boarding actions and hit and run attacks of any type.

Ram Prow +10 points
(Not for escorts.) This adds +1 bonus when rolling a leadership check to ram and causes 1Hp before rolling to inflict damage.

Tellyporta +30 points
(Not for escorts.) Hit-and-run teleport attacks can be made to 30cm.

MORE GUBBINS

The following gubbins can be taken by any number of capital ships in the fleet. More Gubbins are not available for escorts (except the Grunt where indicated) and can only be added to capital ships.

Klaws +10 points
(Not for escorts except the Grunt at +5 points per escort.) Klaws are unaffected by special orders of any kind but cannot be used by capital ships if they are crippled. Any time the ship moves in base contact with any one enemy ship during the movement phase, immediately roll two D6. Each roll of a 4+ inflicts

one hit on the target, ignoring shields but not holofields. Brace for Impact works normally against attacks by Klaws.

Each ship with Klaws may only use it once per turn, regardless of how many vessels it contacts during the Ork player's movement phase, though it does not have to be the first ship in contact. If the Klaws hit only once or not at all, the ship can continue moving after making the attack and shoot/launch ordnance later in the turn. If both attacks hit, then the vessel has grabbed the target with its enormous mechanical Klaws and has latched on! Neither vessel can move if they are of the same class or smaller (such as cruiser to cruiser), but a larger class vessel may still move but only at half rate. Both ships may shoot at half effectiveness (nova cannon and similar special weapons cannot fire). In every End phase roll to attack again (two dice needing 4+ to hit). If both attacks hit when a vessel is already grappled then it takes a third additional hit. Either ship may conduct boarding actions as normal. Damage caused by Klaws cause critical hits as normal.

Shokk-Attack Lance Free
(Not for escorts.) A ship's prow heavy gunz batteries can be replaced with this weapon, which cannot be used if the ship is crippled or braced. It is only effective against ships with shields down in the same manner as teleporters. When used, the ship rolls to hit on a 4+, range: 30cm. Holofields and being braced both save normally against this. If a hit is rolled, D3+1 snotling hordes are teleported onto the enemy ship! If a miss is rolled, place a blast marker in base contact with the vessel (even if shields are already down) for the hordes of vacuum-frozen snotlings bashing against the exterior of the hull. Each hit does not cause damage. Instead, the next leadership check or special order made by the ship must be with an extra D6 (such as 3D6, or even more when already using 3D6, such as when All Ahead Full through an asteroid field)! Additional "hits" from this weapon only add to the number of hordes that must be eradicated before the ship can return to conducting leadership checks normally. Every special order done in this manner (even if failed) "repairs" one of these

hordes as the crew works furiously to shove thousands of snotlings out the nearest airlock! These can also each be repaired in the end phase normally when rolling to repair critical damage.

Escorts have fewer complex systems than capital ships and are smaller overall. While multiple snotling hordes can possibly get into some vital system that in the end overwhelms the vessel, it is just as likely they will miss vital spaces entirely. When fired at escorts, the defending squadron rolls a D6. On a 4+, the closest escort gets an additional blast marker placed in contact with it as the hordes have no effect. On a roll of 3 or less, the nearest escort in range with no shields is destroyed (being braced works normally).

Traktor Field Free
(Not for escorts but required on the Grunt.) The ship upgrades to battleship base size, and it may not use Come to New Heading special orders.

Assault Karrier Free
(Not for escorts.) Any ship that takes both attack craft and torpedoes can be optimized for hit and run attacks and boarding actions by particularly zealous Orks. It takes boarding torpedoes for free, but it may only use assault boats. It may launch +1 assault boat marker each time it launches attack craft normally (even if crippled or braced, but not both).

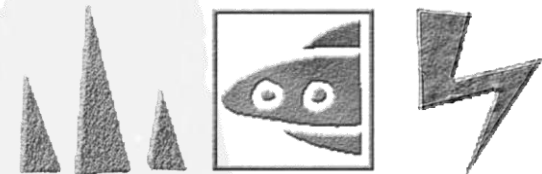

MUSTERIN' DA CLANZ

Orks live in tribes, individual armies each led by a Warlord. However, Orks are also divided into clans, ancient allegiances to which the Orks remain loyal throughout their lives, no matter which tribe they fight for or against. Tribes frequently break apart or are conquered by larger, more powerful tribes, but no matter what an Ork will retain the colors of his clan. Tribes usually contain Orks from several clans, but an

Ork's first loyalty is always to his Warboss. Members of the same clan may well end up fighting one another if their tribes clash, though this doesn't really bother the Orks too much, who will cheerfully fight anyone they can. Each clan has its own distinctive character and abilities, and an Ork will retain these no matter which tribe he belongs to.

CLAN UPGRADES

A Warlord and his skwadrons may only be from one clan, but as many different clans as desired can be in a single fleet. In fact, it is perfectly legal for every single Warlord in the fleet to be of a different clan. Any skwadron can be given a clan upgrade by paying the points cost shown, but the skwadron must show clan colors. In case players have any smart ideas about showing all the colors on their Ork ships for maximum flexibility, a skwadron only counts as showing clan colors if the majority of the ships in the skwadron have their clan color covering more than half of the model. The colors for each clan is shown after the points cost for the upgrade.

Note that although these rules refer to skwadrons, this also applies to single vessels (since battleships, battlekroozers and kroozers can, of course, be fielded in 'skwadrons' of one). Additionally, being from a particular clan and being painted as such does not obligate the skwadron to take the benefits of being from a particular clan by paying the extra points for them, nor are Ork vessels limited to only these paint schemes. It's not uncommon for Ork freebooters to incorporate several color schemes in their ships, when they bother to paint their rust-buckets at all!

Clan upgrades are different from Gubbins and may be taken (and paid for) in addition to Gubbins by individual skwardons. If taken, every capital ship in the skwardon must separately take and pay for the clan upgrade, not just individual ships. Just as with Gubbins, the point cost for clan upgrades for tiddla skwardons count for the whole skwadron in the same manner Gubbins do in all respects.

Goffs +20 points/Black

The Goffs are the most aggressive of the Ork clans, born fighters amongst a race born for fighting. Goffs

like it up close and personal, and consider the other clans wimps for hanging back and shooting. All Goff ships (including tiddla skwadrons) gain a +1 bonus to the dice roll during boarding actions and a +1 Leadership bonus when attempting to ram.

Evil Sunz +20 points/Red

Evil Sunz are obsessed with speed, endlessly tinkering with the engines of all their vehicles and ships, trying to get as much speed out of them as possible. All Evil Sunz ships gain +5cm speed.

Bad Moonz +30 points/Yellow

Bad Moonz are the richest of the clans, using their own fast-growing teeth as currency (this also has the effect of making Bad Moonz a valuable target for other Orks). Bad Moonz don't mind being a target though, and proudly display their wealth through a combination of gaudy colours and all the best gizmos that money can buy. All ships in a Bad Moonz skwadron gain the Maniac Gunners upgrade.

Deathskullz +30 points/Blue

The Deathskullz are the masters of salvage. After a good old scrap it will always be the Deathskullz who are whizzing about scrounging what they can from any wrecks left floating across the battlefield. Deathskullz capital ships and/or tiddla skwadrons have 'looted' upgrades (torpedoes and/or lances) for no additional cost.

Blood Axes Free/Green

Most Orks distrust the Blood Axes, who they consider to be treacherous gits and cowards who sneak around in poncey clothes to make themselves look like trees. Most of all the Blood Axes are disliked for their dealings with humies and other non-Orks, from whom the Blood Axes proudly 'acquire' various practices and even bits of equipment. The Warlord's ship may take one refit from the Imperial Navy refit table (rolled randomly) for +20 points. A Blood Axe tiddla skwadron of at least six escorts may include up to three Imperial Navy and/or Chaos escorts from any fleet list at their listed cost. These kommandeered vessels must have an Orky color scheme and kustom-job – you can't just borrow the ships from your Imperial or Chaos fleet!

Snakebites Free/Brown

The Snakebites are a primitive clan (even by Ork standards) and use technology only reluctantly. Snakebites will indulge in space travel if it's likely to take them to a new scrap, but are likely to spend much of the journey clinging on to the sturdiest (and least tekky looking) thing they can find. Snakebite capital ship skwadrons can only use space hulks or roks – no other kind of capital ship skwadrons are permitted to bear the clan colors. Snakebite skwadrons gain a special +1 bonus to Command checks when attempting to Brace for Impact.



Using Ork Clanz: The Ork Clanz rules can be used in place of the Ork Pirate Rules in the Battlefleet Gothic rulebook or the Armageddon rules in Armada. However, those rules can still be used instead of these, as long as all fleet list and reserve rules are followed. For example, if you decide to use the escort profiles and point values in the Battlefleet Gothic rulebook, all fleet list rules and restrictions from that fleet list must be used as well, and Ork vessels from other fleet lists can only be taken as reserves.

ZUKOV'S KLAW ORK ASSAULT KROOZER 210 Points

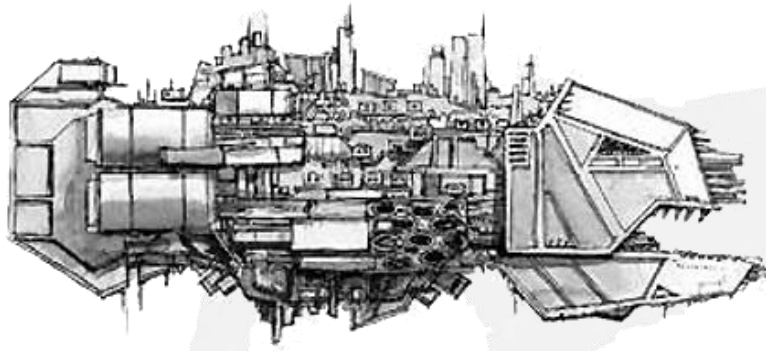

In the confusion prevalent in the latter stages of the Third Armageddon War, a number of new Ork ship classes never before encountered were codified by the Ordo Xenos. Though a protracted war still rages across the surface, careful analysis of the ships encountered in the years since the fleets of Ghazghkull Thraka were dispersed indicate that while there was a great deal of differences between individual capital ships, they still fit into a small number of broad categories in a similar manner to Imperial ship classes.

Like Ork battleships such as the *Kroolboy* and *Gorbag's Revenge*, the *Zukov's Klaw* at first defied conventional analysis and was presumed to be an entirely new ship class. While observed on several occasions vomiting forth prodigious numbers of assault boats, when faced by concerted bomber attacks it was found wanting and depended on nearby Terror Ships for assistance. At first believed to be some kind of specialized assault ship, careful analysis revealed that while indeed optimized for such a role, it was little more than another Terror Ship with several unique upgrades rather than a ship purpose-built to assault enemy vessels. This actually comes as little surprise to Imperial Navy tacticians, as all Ork capital ships are merely refitted cruiser hulks in any case, and it is quite common to find these vessels customized by their crews to at least some extent.

| TYPE /HITS | SPEED | TURNS | SHIELDS | ARMOR | TURRETS |
|-----------------------|-------|---------------------|--------------------|-------------------------------|----------|
| Cruiser/10 | 20cm | 45° | 1 | 6+ prow/ 5+ sides/ 4+ rear | 1 |
| ARMANENT | | RANGE | FIREPOWER/STRENGTH | | FIRE ARC |
| Port gunz | | 30cm | D6 | | Left |
| Port launch bays | | Assault Boats: 30cm | 2/Special | | N/A |
| Starboard gunz | | 30cm | D6 | | Right |
| Starboard launch bays | | Assault Boats: 30cm | 2/Special | | N/A |
| Prow gunz | | 45cm | D6+2 | | Front |
| Prow torpedoes | | Speed: 30cm | D6+2 | | Front |

Special Rules: *Zukov's Klaw* is a Terror Ship that can only be used exactly as described in these special rules. It is of the Goff Clan, giving it both a +1 leadership modifier when attempting to ram and an additional +1 modifier during boarding actions. It is an Assault Karrier upgraded with boarding torpedoes as part of its cost and may launch one additional assault boat during the ordnance phase any time it launches assault boats normally (even if crippled or braced, but not both), but it may not use any other types of attack craft. It is also equipped with Klaws and a Traktor Field as part of its point cost, which does not affect the number of Gubbins a Warlord can upgrade this vessel with for the appropriate points if used as a Warlord's personal ship. *Zukov's Klaw* must be mounted on a large base and cannot use Come To New Heading special orders.

Representing Zukov's Klaw: *Zukov's Klaw* can be represented as easily as mounting a Terror Ship on a large base and using the above profile, point cost and special rules, painted appropriately with lots of black to represent the Goff Clan! Alternatively, you can customize it with as much detail as you want, or even use a suitably salvaged and refitted Imperial cruiser hull if desired (preferably a Dictator) to do the job, again painted appropriately with extra bitz to give it Klaws and a cobbled-together appearance.

Zukov's Klaw may take the place of a Terror Ship in the fleet and represents just one of any number of specialized character vessels that can be made from the current range of Ork capital ship profiles simply by applying the special rules available in this list. This is not restricted to Kroozers and Terror Ships; special-character battlekroozers can be made from these rules as well. While there is no restriction preventing these rules from also being applied to one or more of the named Ork battleships, those vessels are already quite special (and expensive) in their basic forms and already represent highly modified battlekroozers. Ideally an Ork fleet should be led by only a few highly-customized character vessels followed by a larger number of their more generic variants, but there is no reason why an Ork fleet can't consist largely (or even exclusively) of highly customized "flash gits" capital ships followed by just enough tiddla skwadrons to fulfill the requirements of this list.

ORK LITE KROOZER

90 Points



While encountered on occasion wherever the Orks carried their incessant Waaghs! into Imperial space, it was only during the Third War for Armageddon that Ork Lite Kroozers were seen in any numbers. While many have postulated why this is so, the general consensus among tacticians is that like everything else about Orks, bigger is always better. Orks will rarely stop at improving or adding to their vessels until it reaches a point where it is beyond the resources of technical abilities of most Ork warbosses to make them any larger. In this respect the Lite Kroozers encountered may quite often be works in progress, vessels ramshackle even by Ork standards and rushed into battle by their reckless Kaptains while still gathering the teef and gubbins to fully outfit their vessel in an Orky fashion!

Ork Lite Kroozers were seen in a wide variety of forms during the Third Armageddon War, including several bizarre variants super-customized almost exclusively for ramming and boarding actions. While some appeared to be constructed from captured Dauntless or Endeavor light cruiser hulls, some took more bizarre forms and defied any classification whatsoever.

| TYPE /HITS | SPEED | TURNS | SHIELDS | ARMOR | TURRETS |
|-----------------|-------|--------------------|---------|-------------------------------|---------|
| Cruiser/6 | 20cm | 45° | 1 | 6+ prow/ 5+ sides/ 4+ rear | 1 |
| ARMANENT | RANGE | FIREPOWER/STRENGTH | | FIRE ARC | |
| Port gunz | 30cm | D3+1 | | Left | |
| Starboard gunz | 30cm | D3+1 | | Right | |
| Prow gunz | 30cm | 2 | | Front | |
| Prow heavy gunz | 15cm | 4 | | Front | |

Special Rules: Ork Lite Kroozers are essentially capital ships rushed into battle incomplete and as-is. For no change in cost, they may exchange their prow heavy gunz for D6 torpedoes or an additional D6 gunz (for D6+2 in total).

Representing Lite Kroozers: By their very nature, Ork Lite Kroozers come in a wide array of forms. They may represent a captured or salvaged Imperial light cruiser hull instead of the larger Imperial or Chaos cruisers Orks more typically build their Kill Kroozers and Terror Ships from. Conversely, they may have originated from an enterprising Ork Kaptain that cut apart and bolted together several escorts he captured, salvaged or even re-appropriated from his own skwadron! Like all Ork capital ships, each one is a never-ending work in progress so feel free to represent it any way you like, painted appropriately of course.

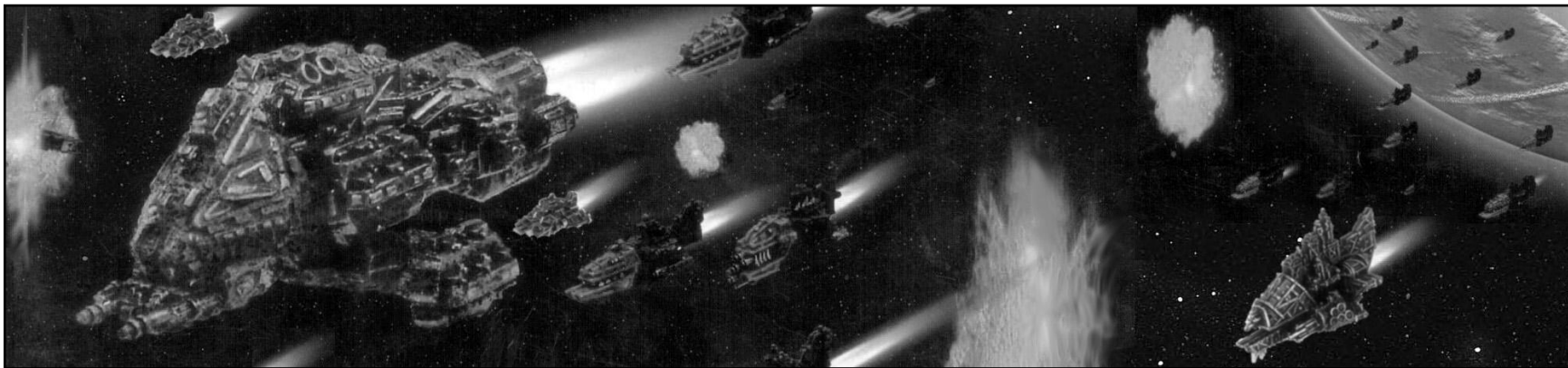

RAVAGER ATTACK SHIP 40 Points

| TYPE /HITS | SPEED | TURNS | SHIELDS | ARMOR | TURRETS |
|--------------|-------|-------------|--------------------|------------|----------|
| Escort/1 | 20cm | 45° | 1 | 6+ prow/4+ | 2 |
| ARMAMENT | | RANGE | FIREPOWER/STRENGTH | | FIRE ARC |
| Torpedoes | | Speed: 30cm | D6 | | Front |
| Gunz Battery | | 30cm | 2 | | Front |

Ork torpedo attacks tend towards an opportunistic approach rather than being used as a major tactic. In part, this is doubtless due to the quality of their crews, which seem to be unreliable at reloading ordnance in the heat of battle. Nonetheless, Ravagers mount a vast number of torpedo racks and when they succeed in launching salvos of torpedoes, they can be worryingly large.

ONSLAUGHT ATTACK SHIP 35 Points

| TYPE /HITS | SPEED | TURNS | SHIELDS | ARMOR | TURRETS |
|--------------|-------|-------|--------------------|------------|----------|
| Escort/1 | 20cm | 45° | 1 | 6+ prow/4+ | 1 |
| ARMAMENT | | RANGE | FIREPOWER/STRENGTH | | FIRE ARC |
| Gunz Battery | | 30cm | D6 | | Front |

The Onslaught attack ship is ugly, difficult to maneuver and lightly armored along its flanks and rear; it is only suitable for head-on attacks. However, a swarm of Onslaughts can lay down a fearsome hail of fire from their multiple forward gun batteries. This is combined with thick frontal armor and shielding to protect them during their initial attack run.

SAVAGE GUNSHIP 30 Points

| TYPE /HITS | SPEED | TURNS | SHIELDS | ARMOR | TURRETS |
|------------|-------|-------|--------------------|------------|----------|
| Escort/1 | 25cm | 45° | 1 | 6+ prow/4+ | 1 |
| ARMAMENT | | RANGE | FIREPOWER/STRENGTH | | FIRE ARC |
| Heavy Gunz | | 15cm | 4 | | Front |

More extreme than even the Onslaught, the Ork gunships known as Savages mount only short-ranged forward heavy gun batteries. In open battle, Savages are less of a threat than the longer ranged Onslaughts, as they can be outmaneuvered and destroyed from a distance. But in an ambush situation, where Orks are lurking in wait amongst asteroids or debris, Savages make for a highly dangerous foe.

GRUNT ASSAULT SHIP 30 Points

| TYPE /HITS | SPEED | TURNS | SHIELDS | ARMOR | TURRETS |
|--------------|-------|-------|--------------------|------------|--------------------|
| Escort/1 | 25cm | 45° | 1 | 6+ prow/5+ | 2 |
| ARMAMENT | | RANGE | FIREPOWER/STRENGTH | | FIRE ARC |
| Gunz Battery | | 30cm | 2 | | Left/ Front/ Right |

Special Rules: Grunt assault ships embark huge crews of Ork boarding parties and are equipped with tractor fields, powerful boarding drills, etc. They roll 2D6 against an opposing ship when ramming and count as 2Hp when determining their boarding value (before other modifiers). These ships are equipped with a Traktor Field and must be mounted on a large base, and due to their poorly distributed mass cannot use *Come To New Heading* special orders. Grunt assault ships can be equipped with Klaws for +5 points each vessel, not per skwadron.

Orks are masters of crude improvisation and salvage, and nowhere is this more apparent than the Grunt assault ship. Easily mistaken for the Brute ramship visually, it is in fact fitted with a huge tractor field generator, giving it the graviometric imprint of a battleship class vessel. It carries a heavily armored piercing prow as well as boarding chambers for a mass of Orkish warriors ready to rush aboard in a green tide. If not for the poorly distributed mass of the Grunt, it would make a truly fearsome opponent against other escorts, though its lumbering approach run is well-suited against capital ships.

CHOOZIN' YER FLEET – DA ORK CLANZ FLEET LIST

WARLORD

Ork fleets always include one Warlord for every 500 points, or part, that the fleet is worth – no more, no less.

Ork Warlord **Free**
A Warlord adds +2 to one boarding dice roll per game. A Warlord has one re-roll, and may purchase one or two more for the points cost shown below.

One extra re-roll **20 points**

Two extra re-rolls **40 points**

A Warlord may choose for his own ship or escort skwadron one upgrade from the Gubbins list for every re-roll he has at its listed cost. He must be embarked on the most expensive ship under his own command (as opposed to the whole fleet), even if it is an escort - annotate which one it is. A Warlord's re-rolls only count for the skwadrons under his command and not for the whole fleet.

SKWADRONS

The Warlord must be in command of one tiddla skwadron and one other skwadron type for every re-roll he has. There is no restriction for what kinds or how many of what type of skwadrons are in the fleet as long as no more than one of each of the named Ork battleships is in the fleet, and no Warlord may have more than one 'Uge Ship. Each skwadron must be fielded with the number of ships chosen for it in this list; you can't split up skwadrons or add more ships to them. He may also swap leadership with any one ship or escort squadron under his command as well.

Different skwadrons under the command of the same Warlord may be combined together if allowed in the normal rules. For example, if a single Warlord has two skwadrons each with two Kill Kroozers or two Ork Rokks, these may be combined together in a single cruiser squadron in battle, as a cruiser squadron may consist of up to four ships (For the purposes of capital ship squadrons, Rokks can only be squadroned with Rokks). However, capital ships under different Warlords may not squadron together. Ork

escort squadrons may consist of up to but not more than ten escorts.

'UGE SHIP SKWADRON

- 1 Battlekroozer/ship*, chosen from the following list:
 Gorbag's Revenge Ork Battleship 310 points
 Slamblasta Ork Battleship 295 points
 Dethdeala Ork Battleship 275 points
 Kroolboy Ork Battleship 270 points
 'Ammer Class Battlekroozer 245 points

BIG SHIP SKWADRON

- 1-2 Kroozers*, chosen from the following list:
 Ork Terror Ship 185 points
 Ork Kill Kroozer 155 points
 Ork Lite Kroozer 90 points

TIDDLA SKWADRON

- 3-10 Escorts*, chosen from the following list in any mix desired:
 Ork Ravager Attack Ship 40 points
 Ork Onslaught Attack Ship 35 points
 Ork Savage Gunship 30 points
 Ork Grunt Assault Ship 30 points
 Ork Brute Ram Ship 25 points

ROK SKWADRON

- 1-4 Rokks*:
 Ork Rok 80 points

SPACE HULK

An Ork fleet with at least three Warlords may include one Space Hulk. One of your Warlords must be embarked on it, which by itself counts as all the skwadrons that Warlord can have (including a tiddla skwadron), regardless of how many re-rolls the Warlord has. Space Hulks so led can take upgrades from the list of Gubbins for double the listed cost except any upgrade that increases its boarding value or speed.

- 1 Space Hulk*
 Ork Space Hulk 600 points



ORK ORDNANCE

Ork attack craft carriers use fighta-bommas and assault boats. They may take torpedo bommas for +10 points per launch bay (counting maximum number of launch bays). Ork capital ships that use torpedoes may use boarding torpedoes for +5 points.

USING SKWADRONS

All fleet restrictions for Orks remain in place in that no more than one 'Uge ship may be taken in the fleet for every two kroozers, and a Space Hulk may only be taken by a fleet of no less than 1500 points. These restrictions however apply to the fleet as a whole, not to individual skwadrons. While there must be at least one Warlord for every 500 points in the fleet or portion thereof, it goes without saying that not all Warlords are created equal. Thus, the smallest fleet a single Warlord with only one re-roll may command is two tiddla skwadrons, each with three escorts. The largest fleet a single Warlord with three re-rolls can command is one 'Uge ship, two skwadrons of kroozers and three skwadrons of up to ten escorts each. Needless to say, such a fleet would be very expensive so the other Warlords in the fleet would likely be commanding very small fleets of their own! This can be mixed and matched in any way desired; it is perfectly legal for a Warlord with one re-roll to have a single 'Uge ship and a tiddla skwadron of three escorts, or instead he may only lead two Rokks and a skwadron of ten escorts, etc. A Warlord leading a Space Hulk may only lead it and no other ships.

In campaigns, nominate one Warlord to command the fleet. This is essentially "you" and must be in the most expensive ship in the fleet, even if it is a Space Hulk. The fleet commander still starts with one re-roll and earns more (along with more skwadrons) over the course of the campaign. However, this means the fleet commander personally starts with no more than one tiddla squadron of up to ten escorts and one other skwadron, which may be taken in any manner desired, and fleet commander re-rolls can only be used by his or her own skwadrons.

T'AU KOR'OR'VESH – THE ARMADA

EVOLUTION OF THE TAU BATTLEFLEET

As the nascent Tau began to stretch their hand across the stars and assume the manifest destiny they saw within themselves to colonize the greater galaxy, it was only a relatively short time before they began to encounter other spacefaring races. Because their own interstellar drive systems were derived in part from alien technology discovered on one of the moons in their home system, they were from the outset very open-minded to this possibility and were quick to form trade agreements and colonization pacts with all they encountered. The first of these was the natural deep-space explorers that are the Nicassar. The Tau's technology proved to be vastly superior between the two, and the inevitable conflict arising from misunderstanding proved to be relatively short. Extremely poor warriors and completely unsuitable for a military role in the Greater Good, the Nicassar lent their natural skill in space to building vessels for the Empire, and their innate curiosity and desire to explore the galaxy made them uniquely suitable as scouts, slowly and methodically plying the depths of space between the stars.

Heady with this success, the Tau earnestly believed that no race they encountered could turn from the unsullied logic of "greater good" as well as the superior technology they had at their disposal. When they once again encountered another spacefaring race, they quickly rushed to establish contact. Their naïve suppositions were cruelly shattered. What they encountered were Ork raiders, brutal killers bent only on war and conquest. Referred to as the

"Ours is to be an empire of worlds, not merely of castes or nations, or races or peoples. To simply control the worlds which we claim as our own will not be enough – we must control the paths between them also, or be divided, and so fail."

– The Air Caste Petition
ahead of the Tau'n Campaign

O'res'la, it took little time before first contact with the Orks turned to open war. While this vanguard was rebuffed after much struggle, it proved in the intervening centau'cyr to only be a foretaste of the woe that was to come. At first the Tau took it to be a war of ideologies, as the O'res'la expansion directly interfered with the Tau's plans at colonizing and expansion of their sphere of influence. It was not long before the realization set in that this was indeed a battle for survival, as the O'res'la with their technologically superior vessels quickly cut lines of communication between worlds and threatened to come within range of the Phase One Septs themselves. In the midst of this, the Tau continued to expand their sphere of influence in the systems surrounding their homeworld in their race to explore and colonize the stars. They rightly ascertained this was not only paramount to their manifest destiny, but quite possibly could prove to be the key to their very survival.

This ethos proved itself during an otherwise unassuming merchant expedition to newly discovered Pech, the homeworld of the Kroot. A lasting alliance was forged in the fires of battle as the visiting delegation and its cadre of Fire Warriors stood beside the local defenders against an invading O'res'la war-host. During this battle, the Kroot proved themselves to be quite able defenders as well as frightfully brutal and efficient close-quarter fighters. The Ethereals, recognizing an unparalleled opportunity to gain an ally as well as a new source of information vital for their cause, quickly interceded to negotiate a lasting peace and alliance between the two races. The Kroot took advantage of an opportunity to expand their access to technology and resources, willingly allowing themselves to become subjects in a sense and forming an alliance that quickly became a cornerstone of the emerging Tau Empire. In return, they lent their expertise in hand-to-hand fighting and natural warrior skill to benefit the Tau, using this opportunity to expand their

travels and pursue the hunt, constantly shaping and improving their genetic bloodline by sampling the gene pools of alien creatures and races they encounter.

As they continued to expand, the Tau encountered the Demiurg, another spacefaring race with which the Kroot had long experience as hired mercenaries. Plying the stellar void in ponderous, stately factory ships and powerfully armed commerce vessels, this ancient race saw an unusually strong kinship between themselves and the Tau. Referred to by the Tau as the Bentus'la (Lit: *wise-gifted ones*), they declined an invitation to join their Empire. They did however realize that together they could be potent allies against continuing predations against the Orks, as the Demiurg's history with them in particular was an exceedingly long one brimming with hatred, loathing and bitterness. In particular, Brotherhoods referring to themselves as Thrum and SrryTok in their unusual, clicking, consonant-heavy language formed strong economic partnerships with the Tau.

Technological advancements gained through this relationship completely revolutionized Tau weapon development as well as the very structure of the Shas (Fire) caste and its role in the Tau's interstellar exploration. Now the Tau were capable of building vessels that could fight the Orks on equal terms, and they wasted no time applying these technologies to new starship designs. Both Gal'Leath explorers and the ubiquitous Il'fannor heavy transport maintained the ability to tow with them large cargo lighters capable of quickly transporting large quantities of materiel between orbit and a planetary surface. However, it was found that by replacing the cargo capacity of these lighters with modularly mounted ion cannons, they could quickly be transformed into extremely capable escort gunships in their own right. This new escort design, dubbed the Kess'l, proved to be so successful at defending their charges that ion cannons were applied to Il'fannor vessels

themselves, a measure that met with only limited success. Because the Tau found this arrangement to be less than satisfactory, they did not attempt to place these weapons on their Gal'Leath vessels, though the Bor'kan Sept produced a variant of the Gal'Leath that substituted launch bays with a powerful gravitic launcher system capable of putting a veritable storm of drone-linked missiles into space.

These advances came just in time. Sporadic attacks on Tau shipping and communication lines erupted into the inexorable tide of Waagh! Scraghurtz, a vast Ork armada sweeping through that part of the galaxy, already responsible for overrunning dozens of worlds. Despite the Tau's technological advances, it was likely that they would not have prevailed against the amassed might of Waagh! Scraghurtz. Unknown to the Tau however, the Demiurg cultivated relations with races even far more ancient than themselves, and in less than a kai'rotaa the grim pressure this mighty Ork-mada applied to the fledgling race vanished as suddenly as it came.

In the route of its expansion, it was inevitable that the Tau would eventually encounter the unimaginably vast domain that encompassed the Imperium of Man. The well-documented Damocles Gulf Crusade and their war with whom they called the Gue'la was the nearly inevitable result. As fortune would have it, the Tau already had established relations and trade agreements with a number of Rogue Traders. This served them well, as they to an extent has a measure of preparedness for what to expect. The human invasion fleet was nonetheless brutally efficient, and the Tau suffered mightily in this war. The outcome at Hydrass in particular was widely considered to be a disaster by the Tau. Lessons learned were rapidly applied however, and they developed their first true interstellar warships in the form of the Kir'Qath escort as analogues to those they faced, serving alongside exploration carracks and heavy transports refitted as combat vessels using up-rated weapon and defensive systems. Though constructing dedicated warships was against the philosophy of a culture that



strived to solve every challenge with diplomacy, trade, ingenuity and not a little cunning, it was recognized that it was necessary against such an intractable foe as the Orks. Despite this, warships were initially produced very sparingly, as many of the Ethereal Caste believed that the bulk of the Kor'vattra's resources needed to focus on its primary goal: commerce and exploration to unite the stars in support of the Greater Good. Once again the fickle hand of fate played in favor of the Tau, and the Gue'la were forced to commit to a cessation of hostilities, beset on multiple fronts by a burgeoning assault by what they called Hive Fleet Behemoth as well as continuing raids by the O'res'la.

The lessons of the Lithesh War were not lost on the Tau, and within twenty tau'cyr of the Armistice, the

Lar'shi cruiser took to space, the Tau's first purpose-built warship and the vessel with which they would re-take the stars. Parallel to this, various capital ship and escort variant designs were experimented with. While the Lar'shi was a formidable warship in its own right, it was still based on the modular transport concept the Tau relied on for generations, a concept favored by the Kor caste that was simple to construct and maintain but suffered the same efficiency and interstellar warp dive shortcomings as other Tau vessels. Nonetheless, these warships proved their worth, and they increasingly became available throughout the Tau fleet. As Tau technology evolved to match that of the Gue'la, it began to easily surpass that of the Orks, and a modernized fleet defending the D'yanoi system handily defeated a comparable fleet of Ork vessels.

In the midst of these advances, a whole new foe revealed itself in what the Gue'la called the Tyranids. Outriders of which were first encountered in the outlying worlds near the Fal'shia Sept, they proved to be an intractable foe, unable to reason, devouring all before them in an insatiable tide of annihilation that consumed worlds as surely as fire does dry brush. Once again the Kor'vattra's performance and tactics against a new enemy were called into question. The problem wasn't yet a crisis, but the Ethereals and Air Caste saw its potential to rapidly develop into one should this new foe prove to be as widespread or problematic as the Gue'la. To



this end, the Ethereals, Air Caste and Earth Caste urgently re-thought their policies for the future development of the Kor'vattra. The Tau finally realized that the status quo was no longer adequate. They would have to bend the full ability, resources and technological prowess at the Empire's disposal to the task of creating a completely new range of vessels designed from the outset as warships with a level of redundancy, efficiency and dive range that were beyond the limits of current starship construction techniques. The faith the Tau have in their Fio caste and its grasp of technology is unshakable, and once again they did not fail to deliver.

Engineers and artificers long familiar with the needs and requirements of the Shas caste were invited into the design process. No effort was to be spared. The project as a whole was soon referred to as the Kor'or'vesh, and it incorporated the single largest re-allocation of resources in the history of the Tau Empire. The result was a new, 'experimental' fleet, a number of radically different starship concepts that bore strong resemblance to the Tau machines of war rather than the modular hulls and platforms familiar to the Kor. For the first time, purpose-built warships were designed to fully integrate the Fire Warrior command structure into the crew, and they represented the very apex of technological

advancement of the Tau race. However, these vessels proved to be especially difficult and expensive to produce, and extensive assistance was required by both the Nicassar and the Demiurg to bring them to fruition. The first vessel created by the new initiative was the Il'Porru, and it proved to be a revolutionary advance indeed. Able to make interstellar dives nearly five times farther than conventional designs, this vessel was promptly taken up by the Por caste as a means to rapidly traverse the breadth of the Empire as well as quickly and efficiently explore beyond their realm. In their first contact, a pair of these vessels quickly bested a small pack of Or'es'la raiders encountered near D'yanoi, proving the concept was sound- and so the Kor'or'vesh, the Tau Battlefleet, came into its own.

The threat represented by the Gue'la subsided but was not removed. Once again they attempted to press their will against the Tau during the Taros Campaign. Fortunately by this time the Tau had finally fielded significant numbers of their new warships, and a number of Septs deployed these vessels in significant numbers only a few tau'cyr before they would be tested in the fires of battle against an Imperial fleet. Quickly called to the front from throughout the Empire, these vessels became the core of a newly created fleet command to meet the invasion fleet head-on. The first of these new

... it has been concluded that, after careful analysis of data gathered during the Damocles Gulf crusade, that this new race identified as the Tau (ref AdMech 5432/XEN583) poses a threat to the Imperium unlike any other yet encountered. Interrogation of prisoners known to have colluded with these xenos describe them in various different ways, but the same basic trends appear pointing to a common theme, describing this race in glowing expressions like "dynamic," "open-minded," "compassionate," and other terms expressing ideals that are markedly out of keeping with willful obedience, service and discipline, as well as representing a direct threat to order that has maintained our blessed Imperium for uncounted centuries. Furthermore, their evolutionary traits represent a rate of development orders of magnitude more accelerated than any sentient life form previously encountered (possible Chaos influence?), at a level that cannot even be explained by Zachary's Theorem of Adaptive Divergence (ref AdMech 32/XEN583). Evidence exists that even as contact with Imperial units increase, the level of development evident in the vessels they array against us continues to increase in complexity and technological development. In particular, xenos vessels encountered during the Taros Campaign show extremely marked advances in both weaponry and design theory compared to those encountered during the Damocles Crusade (ref AdMech 8748821/XEN583, notes on new classes "Emissary," "Warden," etc.) Recommend directive be made to all Imperial units that great care should be taken to prevent our blessed technology from falling into the hands of these aliens, especially our venerable starships and weapons of the Legio Titanicus. If necessary, steps should be taken to destroy what cannot be recovered, with a level of prejudice exceeding even that reserved against the foul Orks. Emperor forbid what circumstance may come to pass should these aliens ever develop the ability to construct a Titan, or warships that approach a level of capability comparable to ours...

-Morris Montesigna, Genetor Secundus

ships to be encountered by the Imperial fleet was the II'Porru during fighting in the Dolumar system. Codifying it as the 'Emissary' class, the single vessel was eventually destroyed, but the new class of ship was noted with surprise and concern amongst many commanders and tacticians, more than one assuming erroneously that the Tau had established an alliance with a hitherto unknown, highly advanced alien race.

The Tau took advantage of their new capabilities to stretch the hand of their Por-caste diplomats far and wide, encountering a number of new, minor Xenos races such as the Vespids and inviting them to join their empire as part of the Greater Good. It was not long afterward that new, larger variants of Kor'or'vesh ship designs were encountered in increasingly larger numbers by the Imperial Navy as the Taros Campaign progressed, the Tau using this conflict as a testing ground. Up to this time they had been nothing more than anomalies, encountered only occasionally as the Imperial fleet progressed into Tau space. The arrival of these new ships in substantial numbers took Fleet Admiral Kotto by surprise. Given the Tau fleet's performance, their numbers may increase as the Kor'vattra of other Septs seek to adopt the new classes, integrating them into their fleet structure as these ships redefine the Kor's role in defending and advancing the Greater Good.

These dedicated warships are far too precious to be used merely as convoy escorts or deep-space patrol vessels, as these roles are already suitably engaged by other starship designs. However, the Tau depends on the Kor'or'vesh to defend their vital Phase One Septs, and will also unhesitatingly deploy them in force to support a particularly vital commerce and exploration fleet. They are also called upon to perform punitive expeditions against pirate raiders or as an invasion fleet for a hotly contested system. Finally, a race so keenly attuned to the importance of commerce and exploration is quick to grasp the impact of interrupting the lines of communication and provisions of an enemy. It is not uncommon to see these ships used as commerce raiders, as the older designs were used on occasion for many hundreds of tau'cyr.

DOSSIER: Kor'O Vash'ya Y'eldi Mesme - 110 points

At 41 Tau'cyr, O'mesme is of a great age for his kind, but this has done nothing to dim the fire in his eyes or the great skill and subtlety with which he wields the ships under his command. Hailing from a world renowned for the history and tradition of its Kor caste, he began his career as a pilot for one of the fighter squadrons of the Kor'vattra. Quickly advancing to the level of squadron commander and soon that of an entire Gal'Leath attack craft wing, he earned the title of Y'eldi, or "winged one," for his particularly gifted skills as a pilot in their unceasing conflicts against the Orks. Moreover, his tactical genius did not go unnoticed, and it was only a matter of time before he was selected to command a starship, first as command pilot of a Kass'l gunship, then later of the first ship to carry his name, the T'olku II'fannor M'poth Vash'eldi.

It was at this time that he was given the name Mesme, when assigned as a flotilla leader of two other II'fannor vessels by his Kor'O as part of a colonization fleet near Tash'var. During a surprise attack by Ork pirates, he daringly interposed his vessel between an attacking Onslaught squadron and another II'fannor vessel crippled by an earlier firing pass. During this engagement, he continuously stayed one step ahead of their adversary, constantly interposing his best ships between the attacking enemy and the flotilla. As their railguns continued to hammer out at the Orks, they stubbornly refused to retreat, and in a relatively short engagement the entire enemy squadron was destroyed. Soon afterward he was given command of a Gal'leath exploration vessel, where his exploits against the Orks soon became the stuff of legend. His vessel was at the Dal'yth system when word of the attack against Viss'el by the Gue'la reached them, and he once again performed admirably against these invaders.

Kor'O'Mesme is embarked aboard the Kor'or'vesh vessel *Bor'kan Or'es El'Leath Se'arle O'Mesme*, is Leadership 9 and has two re-rolls. Aun'Shear, a revered member of the Ethereal Caste and a close personal friend, always accompanies him. His love of flight has never diminished, and he continues to fly a fighter out of his own hangar bays, true to his name Y'eldi. This inspires his pilots to drill even harder and accomplish feats of bravery that has made his attack craft wings legendary in the annals of the Tau. The attack craft squadrons of his flagship have the Excellent Pilots crew skill. As a revered fleet commander, his vessel takes advantage of the very best technology the Fio Caste can produce for the Greater Good. His ship can be refitted with Improved Logic Engines enabling his vessel to avoid leadership effects for being in contact with blast markers for +10 points instead of the normal +10% cost.



TAU SPECIAL RULES

TAU WEAPONS

Turrets

Tau turrets are extremely sophisticated, combining a range of weapon types with overlapping fire zones. Note the Tracking Systems special rules. *See p. 29 of the main rulebook for more on turrets.*

Ion Cannons

Ion cannon shots vaporize the object struck magnifying the energy discharge. They function as lances in all respects.

Railgun Batteries

Railguns of the size mounted on warships require massive amounts of energy to fire. Power is routed to a single barrel at a time, sequenced to ensure the first barrel is reloaded before it is charged again. Railguns function as standard weapons batteries.

Gravitic Launcher and Tau Missiles

Gravitic launchers are massive railguns where mass drivers trigger the initial acceleration before the ship's gravitic field is pulsed to squeeze the drone-controlled missiles toward the enemy at enormous speed. Though smaller and more numerous than torpedoes in the regular sense, they count as torpedoes for the strength listed in a given ship's profile. Tau torpedoes are able to alter both speed and trajectory, moving between 20cm to 40cm each ordnance phase. They are guided and may turn up to 45 degrees at the start of their movement. Roll a D6 for each torpedo strength in the salvo at the start of each ordnance phase after the one they were launched, removing one for every 6 rolled.

Attack Craft

Special Rules of the Tau Kor'or'vesh:

Kor'or'vesh vessels incorporate the very highest level of technology available to the Tau. They have a distinctly different appearance to ships of the Kor'vatra. However, except where noted, these vessels follow all standard rules for Tau vessels as presented in Armada.

Kor'or'vesh capital ships embark a number of Fire Warrior cadres specially trained in shipboard combat and boarding techniques as an integral part of the crew. These vessels ignore the rule for Tau ships halving their boarding strength for the size of the ship. However, even these vessels do not have the ability to conduct teleport Hit and Run attacks, as the Tau have not yet mastered this technology to an acceptable degree.

Barracuda superiority fighters behave as fighters in all respects but due to their inferior technology only move 25cm per ordnance phase. Manta Missile Destroyers are enormous and well-defended individual vessels more akin to proper starships than attack craft. When intercepted by fighters, they roll a D6 once per ordnance phase, remaining in play on a roll of 4+. They otherwise ignore any other type of ordnance the same way other bombers do.

Gravitic Hooks

Gravitic Hooks are large, suspensory arms which create a gravitic sheath in which a small vessel can be transported by a larger one. However, gravitic hooks have no effect in game terms – ships do not start a game attached to their parent ship, and can never be docked during a game. Likewise, the number of gravitic hooks is unimportant when calculating victory points, in that an opponent does not get VPs for surviving escorts just because there aren't enough Gravitic hooks to notionally transport them to safety.

TAU SYSTEMS

Deflector

The deflector is a specialized shield mounted on the prow of the latest Tau ships. It turns the gravitic sheath around the vessel into a wedge, increasing its defensive capability. If fired at from the front, the deflector augments the passive armor and counts as armor 6. Deflectors are always mounted on the prow and will be disabled if the ship suffers a prow weapons damaged critical (repaired normally). Deflectors are NOT shields and do not count as such for the purpose of boarding, blast markers or other

effects which apply to shields.

Tracking Systems

Some Tau starships and orbital platforms boast highly advanced data storage and processing facilities to cope with the vast amounts of information they carry. When linked to ship sensors, this processing power can be used to provide a direct feed to the ships turrets. In fleet actions this system can route data to nearby Tau vessels. Any Tau vessel within 10cm of a ship with tracking systems may re-roll misses when using turrets, and ignores the column shift when firing batteries at ranges above 30cm. Tracking systems continue to function even if a ship is braced for impact.

USING TAU STARSHIPS

Unless noted otherwise, Tau vessels follow all the normal rules from the Battlefleet Gothic rulebooks concerning leadership, movement, shooting, critical damage, etc. Tau have an attack rating of 2.

Boarding Actions and Teleport Attacks

All Tau vessels except Kor'or'vesh warships have a boarding strength that is half normal for the size of ship. Kor'or'vesh warships have a standard boarding value. Tau ships may not conduct teleport hit and run attacks.

Campaigns

Tau fleets gain renown and leadership in the same manner as Imperials and may use the refits and crew skills tables on p.156-157 in the Battlefleet Gothic rulebook. They do not have access to the special refit tables listed on p.156-157 of Armada, though they may use the special ordnance rules listed on p.159.



OR'ES EL'LEATH "CUSTODIAN" CLASS BATTLESHIP 330 Points



Experience with the Gal'Leath in combat, particularly against the Gue'la incursion into sovereign Tau space during the Damocles Crusade, demonstrated a number of significant shortcomings that could not be overcome without a radical hull redesign, despite notable advances incorporated into the experimental Bor'kan variant of the venerable Gal'Leath. As the Kor'or'vesh initiative bore fruit with a progressively larger series of completely new and successful hull designs, it was only logical that the next step would be to produce a true battleship-class vessel.

An enormous carrier, it is capable of bringing three gunships as well as a large number of attack craft squadrons into combat to support the rest of the fleet. Early operational tests proved that like the other designs resulting from the Kor'or'vesh initiative, it met or exceeded all objectives required for the new ship. Despite the horrendous costs and resource expenditure involved in building these vessels, a number of Septs adopted the design and produced them in small numbers. For many tau'cyr these ships were held in reserve, and it was quite some time before knowledge of this vessel's existence became widespread.

First encountered by Imperial forces led by Admiral Kotto during the Taros Campaign, the "Custodian" class and its attendant escorts were a complete surprise to the Imperial fleet. Appreciating the threat this class represented, the battleship *A'rho* in particular was ruthlessly hunted down and destroyed by Admiral Kotto's fleet.

| TYPE /HITS | SPEED | TURNS | SHIELDS | ARMOR | TURRETS |
|---------------------------|-------|----------------------------------|---------------------|-------|--------------|
| Battleship/10 | 20cm | 45° | 3 | 5+ | 4 |
| ARMAMENT | | RANGE | FIREPOWER/STRENGTH | | FIRE ARC |
| Port Railgun Battery | | 45cm | 6 | | Left/ Front |
| Starboard Railgun Battery | | 45cm | 6 | | Right/ Front |
| Port Ion Cannon | | 45cm | 1 | | Left/ Front |
| Starboard Ion Cannon | | 45cm | 1 | | Right/ Front |
| Stern Gravitic Hook | | - | Capacity: 3 Wardens | | - |
| Port Launch Bays | | Mantas: 20cm Barracudas: 25cm | 3 | | N/A |
| Starboard Launch Bays | | Mantas: 20cm Barracudas: 25cm | 3 | | N/A |
| Prow Gravitic Launcher | | Speed: 20-40cm | 8 | | Front |

Notes: The gravitic hooks of Custodian battleships are enclosed in a single shrouded, hangar-type enclosure specifically designed for Kir'la "Warden" gunships and are unsuitable for the transport of or to count for other escort types. Custodian battleships cannot undergo Come To New Heading special orders.

Custodian battleships are equipped with a deflector that raises its prow armor to 6. This is disabled whenever the vessel suffers a prow critical hit (repairable normally).

The Custodian has an integrated Tracking System coupled to an extremely sophisticated sensor suite. It functions in the same manner as that on Messenger starships in all respects but has a range of 20cm.



KIR'LA "WARDEN" CLASS GUNSHIP 30 Points

"Warden" shown in attendance with "Custodian" battleship

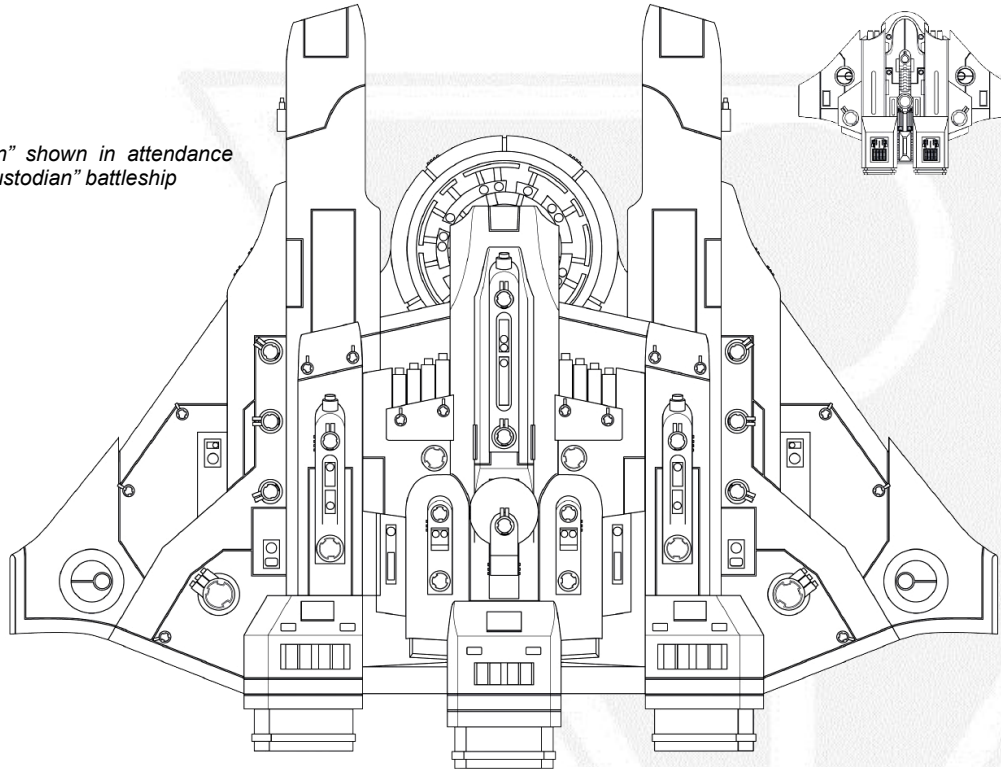

The Kir'la "Warden" is a radical departure in gunship design for the Kor'vattra in that while it still requires towing via gravitic sheath by larger vessels, it is designed for and crewed primarily as a combat vessel as opposed to being a re-configured cargo lighter as is the Kess'l. Because of this, it can seamlessly integrate itself into Kor'or'vesh flotillas, though it will still operate independently as an escort squadron when assigned to escort Gal'Leath or Il'fannor vessels of the Kor'vattra. Because of the high experience levels of its crews and its superior maneuvering qualities when compared to the K'essl, it has proven to be a formidable adversary to attacking raiders. However, its numbers will not be sufficient to replace the Kess'l in active service for quite some time because of its complexity, and only rarely is it used in this manner.

Despite technological advances in etherdrive technology, the Kir'la's small size makes it extremely difficult to put an efficient interstellar drive system into its hull. Thus it must always be towed into combat and launched after its mother ship enters a system. The Or'es El'leath is specially designed to quickly deploy these vessels immediately upon entering combat, and it operates with the Kir'la exclusively as its towed gunship escort. While Wardens have been on occasion used in other roles, it was designed primarily to protect their vitally important carrier battleships and will rarely be seen too far from their side.

| TYPE /HITS | SPEED | TURNS | SHIELDS | ARMOR | TURRETS |
|----------------------|-------|-------|--------------------|-------|--------------------|
| Escort/1 | 25cm | 90° | 1 | 5+ | 1 |
| ARMAMENT | | RANGE | FIREPOWER/STRENGTH | | FIRE ARC |
| Prow Railgun Battery | | 30cm | 2 | | Front |
| Prow Ion Cannon | | 30cm | 1 | | Left/ Front/ Right |

Notes: Any Tau fleet may bring Wardens to battle on gravitic hooks instead of Orcas. Any ship equipped with Wardens can only be equipped with Wardens and may not have other hook-transported escorts. These then form an independent squadron in all respects (including separate leadership), as they are Kor'or'vesh vessels and not necessarily related to the parent vessel transporting them. They may squadron with Castellan escorts in the fleet if present (max. six per squadron) but not with any other escort types.

... You should go back to your Emperor and tell him what you have seen here. Tell him of all the people that will die in his name, and ask him if it is worth such-a price to stand in our way.

- Aun'O T'olkū K'yina



LAR'SHI'VRE "PROTECTOR" CLASS CRUISER 185 Points

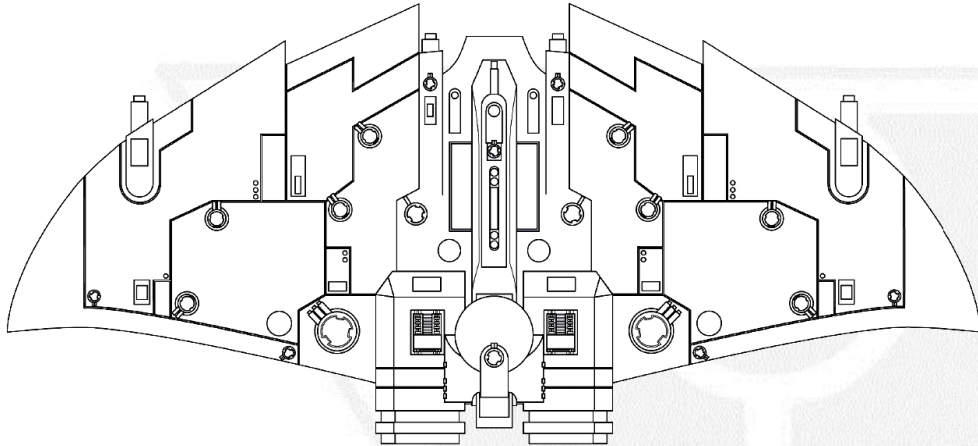

LAR'SHI'VRE T'OLKU CONFIGURATION

| TYPE /HITS | SPEED | TURNS | SHIELDS | ARMOR | TURRETS |
|---------------------------|-------|----------------------------------|--------------------|-------|--------------|
| Cruiser/6 | 20cm | 90° | 2 | 5+ | 3 |
| ARMAMENT | | RANGE | FIREPOWER/STRENGTH | | FIRE ARC |
| Port Railgun Battery | | 45cm | 2 | | Left/ Front |
| Starboard Railgun Battery | | 45cm | 2 | | Right/ Front |
| Prow Railgun Battery | | 45cm | 6 | | Front |
| Port Ion Cannon | | 30cm | 1 | | Left/Front |
| Starboard Ion Cannon | | 30cm | 1 | | Right/Front |
| Prow Launch Bays | | Mantas: 20cm Barracudas: 25cm | 1 | | N/A |
| Prow Gravitic Launcher | | Speed: 20-40cm | 5 | | Front |

Notes: All Protector class cruisers are equipped with a deflector that raises its prow armor to 6. This is disabled whenever the vessel suffers a prow critical hit (repairable normally). Long-range ion cannons are a recent development; T'olku configuration Protectors must outnumber those of the Vior'la configuration in a Tau fleet.

Based on the mission envisioned for the Lar'shi'vere "Protector" cruiser, the Lar'shi'vere "Protector" cruiser is the primary combat vessel of the Kor'or'vesh, the first starship designed by the Tau specifically to engage and destroy enemy vessels in fleet actions. Like many other Kor'or'vesh vessels, this class was first encountered during the Taros campaign. While it does not have the same bulk and durability as comparable Imperial vessels, it is the first Tau design capable of meeting Imperial cruisers on nearly equal terms. Two Lar'shi'vere vessels formed the fighting core of the Tau fleet defending Taros, and it inflicted heavy losses on the invading fleet's transport ships.

In subsequent decades, this vessel has been encountered in ever-increasing frequency, not only in defense of Tau home worlds but abroad outside of Tau-controlled space, operating in pairs while accompanying colonization fleets or as deep space patrols reminiscent of the operations common to the Imperial Navy. They have wasted little time capitalizing on the Imperium's heavy commitments in the sectors near the Eye of Terror, and this class has played a pivotal role in the Tau's recent explosive advance into Imperial space.

Kor'uil Vash'ya Tozhan lowered himself into his blast couch and glanced at the control surface to trigger the emergency restraints. He never locked himself down until the last moment before combat, he was air-caste born and orbital-raised, swimming in zero gravity was far more natural to him than walking. His vessel had accelerated to optimum speed and was rapidly closing with his human quarry. Tozhan confirmed that the intercept point had appeared on his tactical display and a countdown to intercept had started. All his railgun tubes were loaded and the huge energy charge needed to fire them could be released on his command. This was one consignment of Gue'la supplies that would never reach the fighting on Arthas Moloch...

LAR'SHI'VRE VIOR'LA CONFIGURATION

| TYPE /HITS | SPEED | TURNS | SHIELDS | ARMOR | TURRETS |
|---------------------------|----------------------------------|--------------------|---------|--------------|---------|
| Cruiser/6 | 20cm | 90° | 2 | 5+ | 3 |
| ARMAMENT | RANGE | FIREPOWER/STRENGTH | | FIRE ARC | |
| Port Railgun Battery | 45cm | 2 | | Left/ Front | |
| Starboard Railgun Battery | 45cm | 2 | | Right/ Front | |
| Prow Railgun Battery | 45cm | 4 | | Front | |
| Port Ion Cannon | 45cm | 1 | | Front | |
| Starboard Ion Cannon | 45cm | 1 | | Front | |
| Prow Launch Bays | Mantas: 20cm Barracudas: 25cm | 1 | | N/A | |
| Prow Gravitic Launcher | Speed: 20-40cm | 5 | | Front | |

As I scry far across the skein of time to where the mists of the distant future cloud any certainty, the one revelation that over and again asserts itself is the eventuality of conflict between our two races. However, the journey toward that distant end is one replete with the gossamer caress of hope and promise, a faint glimmer in an otherwise frigidly dark and unforgiving universe the likes of which has not been glimpsed since the Fall...

- Glébrwyn Tithrandil,
Farseer of the Alaitoc Eldar

IL'PORRUI "EMISSARY" CLASS ENVOY SHIP 110 Points

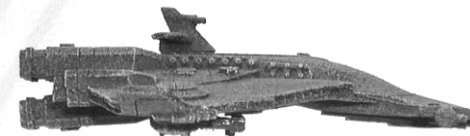
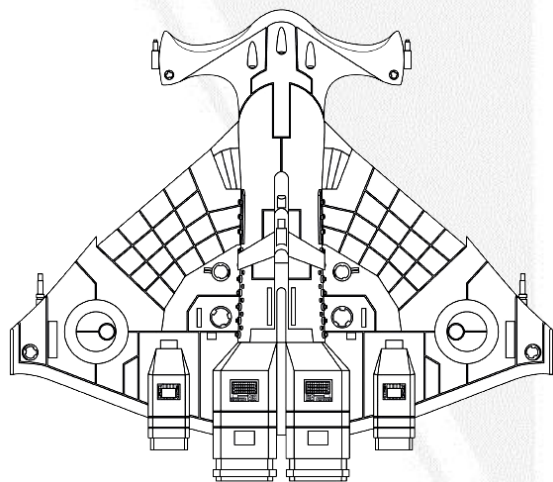

Unlike the other hull designs resulting from the Kor'or'vesh initiative, the Il'Porru "Emissary" cruiser is primarily intended as a diplomatic vessel. This provides it the necessary mix of firepower and maneuverability to make it a suitable conveyance to transport Por Caste dignitaries, Tau commanders and Ethereals in relative safety. By design, it is also capable of seeing off all but the most powerful adversaries of a similar class it may encounter.

As the first capital ship to be produced under the Kor'or'vesh, there are significant numbers of these vessels operating throughout Tau space in a variety of tasks. As befits its nature, it is the vessel with which the Tau perform long range exploration and "first contact" missions. It is often sent to rove far beyond Tau space on diplomatic assignments to the Tau's neighbors or in accompaniment of merchant transports, in this capacity it has most proven its worth to the Tau Empire.

While it may not be a front-line combat vessel, it is well suited to the fires of war, and during the latter stages of the Taros Campaign, a squadron of these vessels successfully boarded an Imperial battleship.

IL'PORRUI DAL'YTH CONFIGURATION

| TYPE /HITS | SPEED | TURNS | SHIELDS | ARMOR | TURRETS |
|---------------------------|------------------|--------------------|---------|--------------|---------|
| Cruiser/4 | 20cm | 90° | 1 | 5+ | 2 |
| ARMAMENT | RANGE | FIREPOWER/STRENGTH | | FIRE ARC | |
| Port Railgun Battery | 45cm | 4 | | Left/ Front | |
| Starboard Railgun Battery | 45cm | 4 | | Right/ Front | |
| Port Gravitic Hook | - | Capacity: 1 Warden | | - | |
| Starboard Gravitic Hook | - | Capacity: 1 Warden | | - | |
| Prow Launch Bay | Barracudas: 25cm | 2 | | N/A | |

IL'PORRUI BORK'AN CONFIGURATION

| TYPE /HITS | SPEED | TURNS | SHIELDS | ARMOR | TURRETS |
|---------------------------|-------|----------------|--------------------|-------|--------------|
| Cruiser/4 | 20cm | 90° | 1 | 5+ | 2 |
| ARMAMENT | | RANGE | FIREPOWER/STRENGTH | | FIRE ARC |
| Port Railgun Battery | | 45cm | 4 | | Left/ Front |
| Starboard Railgun Battery | | 45cm | 4 | | Right/ Front |
| Port Gravitic Hook | | - | Capacity: 1 Warden | | - |
| Starboard Gravitic Hook | | - | Capacity: 1 Warden | | - |
| Prow Gravitic Launcher | | Speed: 20-40cm | 3 | | Front |

IL'PORRUI SA'CEA CONFIGURATION

| TYPE /HITS | SPEED | TURNS | SHIELDS | ARMOR | TURRETS |
|---------------------------|-------|----------------|--------------------|-------|--------------|
| Cruiser/4 | 20cm | 90° | 1 | 5+ | 2 |
| ARMAMENT | | RANGE | FIREPOWER/STRENGTH | | FIRE ARC |
| Port Railgun Battery | | 45cm | 3 | | Left/ Front |
| Starboard Railgun Battery | | 45cm | 3 | | Right/ Front |
| Port Ion Cannon | | 30cm | 1 | | Left/ Front |
| Starboard Ion Cannon | | 30cm | 1 | | Right/ Front |
| Prow Gravitic Launcher | | Speed: 20-40cm | 3 | | Front |

Notes: Emissary class cruisers can be equipped with a deflector that raises its prow armor to 6 for +10 points. This is disabled whenever the vessel suffers a prow critical hit (repairable normally).

A large number of Il'Porru vessels were equipped with specialized grav hooks for supporting Kir'la "Warden" gunships so that it may have a form of escort on long-range emissary missions. These grav hooks are specially designed for Wardens and cannot be used to tow or count for any other kind of escort.



TAU SEPT WORLDS

The world or system from which a Tau hails from forms a large part of his or her identity. The culture of each of these many colonies or so-called sept worlds is subtly unique. This is due in part to the age of the colony – it may be one of the First Phase colonies established during the early stages of the Tau expansion into space, or it may be a much younger society. The relative proportions of the various castes differ from sept to sept too, and this may lend a certain outlook and character to the world's culture and the Tau born there.

Vior'la: A First-Phase colony, Vior'la orbits a binary star, and its name translates as 'hot-blooded.' A notorious Fire Caste world, its warriors are especially aggressive and skilled in the arts of death. The oldest and most respected of the Fire caste academies was founded here many centuries ago.

T'olku: Known for the sage counsel, debating and diplomatic skills of its Ethereal caste members, many of those Tau who have had successful dealings with alien species originate from this Second-Phase world.

Dal'yth: A very cosmopolitan First-Phase world where trade is valued as much as conquest, Tau from here welcome offworlders. As such, it has seen the most contact with alien species. Many Water-caste merchants and traders come from this sept.

Bork'an: A center of learning and academia, it has many universities and research facilities. A high percentage of the Fio, or Earth caste come from this First-Phase world.

Sa'cea: One of the hottest and most densely populated Tau worlds, this First-Phase sept has a greater proportion of Fire Warriors than almost any other and is highly militarized. Those hailing from Sa'cea are regarded as particularly disciplined and honorable warriors.

Vash'ya: Known as the "world between spheres," members of the Kor caste have a long tradition on this Second-Phase sept, providing a majority of the pilots and ship crews for the Tau's early expansion into the greater galaxy.

Ksi'm'yen: One of the first Third-Phase septs, it has yet to emerge as a distinct society. Conquered largely by stealth, a combination of Second-Phase fleets and hunter cadres wrested this from the Imperium when it was stripped of its defenders due to pressing needs elsewhere.

KIR'SHASHVRE "CASTELLAN" CLASS ESCORT 50 Points

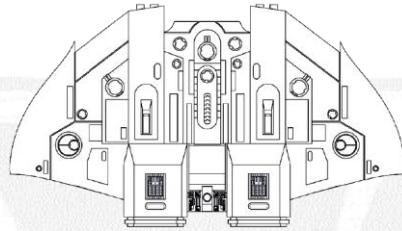

| TYPE /HITS | SPEED | TURNS | SHIELDS | ARMOR | TURRETS |
|------------------------|-------|----------------|--------------------|-------|--------------------|
| Escort/1 | 25cm | 90° | 1 | 5+ | 2 |
| ARMANENT | | RANGE | FIREPOWER/STRENGTH | | FIRE ARC |
| Prow Railgun Battery | | 45cm | 2 | | Left/ Front/ Right |
| Prow Gravitic Launcher | | Speed: 20-40cm | 2 | | Front |

Notes: This vessel may squadron with any other Tau escorts normally except Orcas (max. six per squadron), but those in a squadron with Wardens may not also be with any other escort type.

Operations by the Kir'Qath "Defender" starship revealed that while it was a capable escort, continuing shortcomings in its engineering plant required a new vessel design that could make much deeper and longer dives as well as a larger number of dives before requiring to recharge its primary drives. Like the other vessels designed during the Kor'or'vesh initiative, its unique hull design allows for considerably longer-range operations compared to its predecessor. Deployed in the role of traditional escort vessel, it has proven directly comparable to commonly encountered Imperial designs. Around Taros the Tau fleet deployed Castellans in large numbers in support of their larger vessels with great success.

IL'EMAAR "COURIER" CLASS MERCHANT TRANSPORT Special

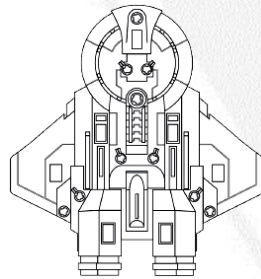

| TYPE /HITS | SPEED | TURNS | SHIELDS | ARMOR | TURRETS |
|----------------------|-------|-------|--------------------|-------|--------------------|
| Escort/1 | 20cm | 45° | 1 | 5+ | 1 |
| ARMANENT | | RANGE | FIREPOWER/STRENGTH | | FIRE ARC |
| Prow Railgun Battery | | 30cm | 1 | | Left/ Front/ Right |

Notes: Il'Emaar merchant transports support the Kor'vattra in a variety of missions but are usually crewed by more junior members of the Kor-caste. They have a -1 modifier when determining base leadership. These vessels are reserved for scenarios that require transports, for which they have the value of a full transport or two assault points.

Using Merchant Transports in a Tau Fleet for scenarios requiring transports

Due to the nature of the Tau Kor'vattra, there are a large proportion of heavy transports in the fleet. In any scenario requiring transports, up to half the transports allowed in the fleet may be replaced with Il'fannor "Merchant" heavy transports if desired, each for their normal point cost. These ships are represented by the variant equipped with gravitic hooks (not ion cannons!). When used, their accompanying Orcas or other towed escorts must count toward the fleet escorting the transports, in addition to the point value of the Merchant starships themselves. They count as two transports in all respects and have four planetary assault points (these values are halved if crippled).

Their long and protracted war with the Or'es'la proved early on that the numerous but relatively fragile merchantmen that were the life-blood of the rapidly expanding Tau Empire were woefully inadequate. Continuing raids decimated the fleets of these small ships, requiring a whole and much larger class of heavily armed transport in the form of the Il'Fannor. As time progressed, smaller transport classes almost disappeared entirely, though many various types still found use among and between the major Septs of Tau space. However, as the Kor'or'vesh began operating throughout Tau space and beyond, a new kind of fast transport was required that could make long, deep dives in support of the fleet and quickly replenish forward-deployed flotillas. While this vessel was originally designed to support the Kor'or'vesh, the obvious utility of these vessels was expanded to the Greater Empire, and now these easily produced starships are common sights throughout Tau space and beyond.

PLANETARY DEFENSES

These Planetary Defense profiles vary slightly from those available in Armada and are perfectly suited for the models produced by ForgeWorld. They can be used in any scenario requiring Planetary Defenses.

TAU KOR CASTE ORBITAL CITY 150 Points

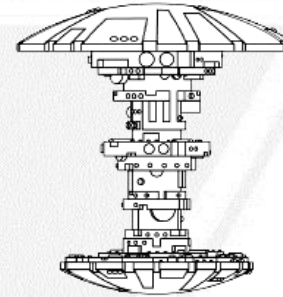
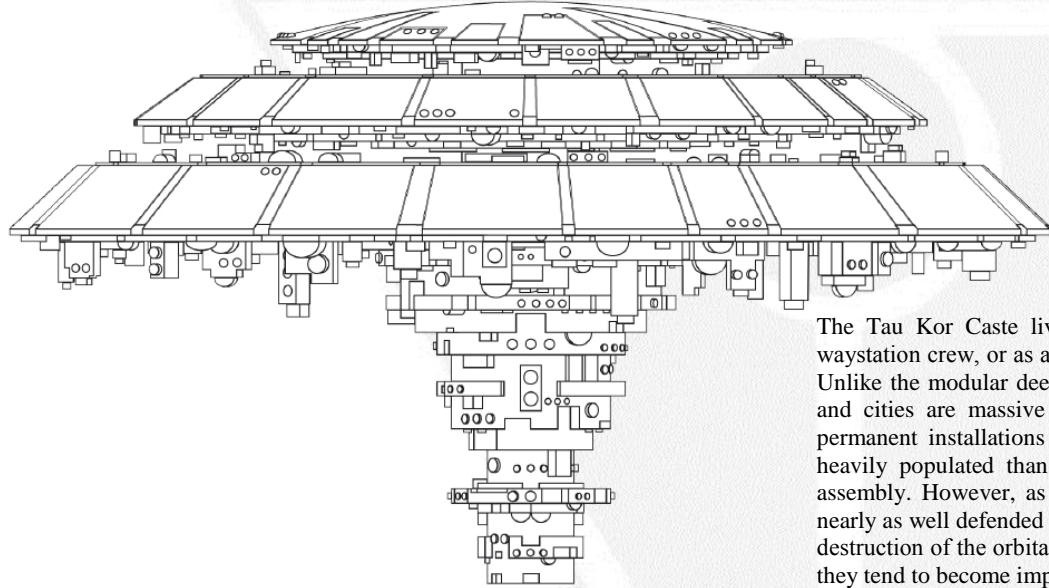

Orbital City and smaller Security Orbital

The Tau Kor Caste live much of their lives in zero-gravity, either as spacecraft or waystation crew, or as a resident in one of many of the Caste's own large orbital habitats. Unlike the modular deep-space way-stations used throughout Tau space, orbital habitats and cities are massive constructs usually assembled in place as permanent or semi-permanent installations in high orbit. By their very nature they are sturdier and more heavily populated than the modular way-stations designed for rapid deployment and assembly. However, as they are primarily designed for habitation, they tend to be not nearly as well defended as other orbital constructs, as demonstrated by the relatively quick destruction of the orbital facilities of Viss'el during the Damocles Gulf Crusade. As such, they tend to become important rallying points when defending against an invasion force.

| TYPE /HITS | SPEED | TURNS | SHIELDS | ARMOR | TURRETS |
|-----------------|-------|--------------------------------|--------------------|-------|------------|
| Defense/10 | 0cm | 0° | 3 | 5+ | 4 |
| ARMAMENT | | RANGE | FIREPOWER/STRENGTH | | FIRE ARC |
| Railgun Battery | | 45cm | 12 | | All Around |
| Launch Bays | | Manta: 20cm Barracuda: 30cm | 4 | | N/A |
| Gravitic Hook | | - | 2 Orcas/Wardens | | - |

Notes: Like many deep-space way-stations, Tau Orbital Cities and Security Orbitals are equipped with comprehensive sensor and communication suites with a high degree of automation. They are equipped with the same Tracking System as "Messenger" starships. Orcas assigned to guard an Orbital City have a base leadership of 7 and cannot squadron with other escorts.

TAU SECURITY ORBITAL 50 Points

| TYPE /HITS | SPEED | TURNS | SHIELDS | ARMOR | TURRETS |
|-----------------|-------|-------|--------------------|-------|------------|
| Defense/4 | 0cm | 0° | 1 | 5+ | 4 |
| ARMAMENT | | RANGE | FIREPOWER/STRENGTH | | FIRE ARC |
| Railgun Battery | | 45cm | 4 | | All Around |
| Ion Cannon | | 30cm | 1 | | All Around |

While most Second and Third-Phase Septs in the Tau Empire rely on quickly deployed modular way stations and Orbitals for their defensive and operational requirements, most primary Septs and a small number of firmly established secondary systems have a quantity of permanently situated orbital defenses. These security orbitals tend to be somewhat stouter than other single-point defenses without the complexity or size of full stations.

ALLIES, SUBJECTS & MERCENARIES

As the Tau more fully integrate themselves with the Demiurg, they make regular contact with vessels rarely encountered by other races. Likewise, their ongoing conflict with the Orks made them party to a supremely rare sight- the power and magnificence of an assembled Demiurg war host.

DEMIURG 'CITADEL' COMMERCE VESSEL 185 Points

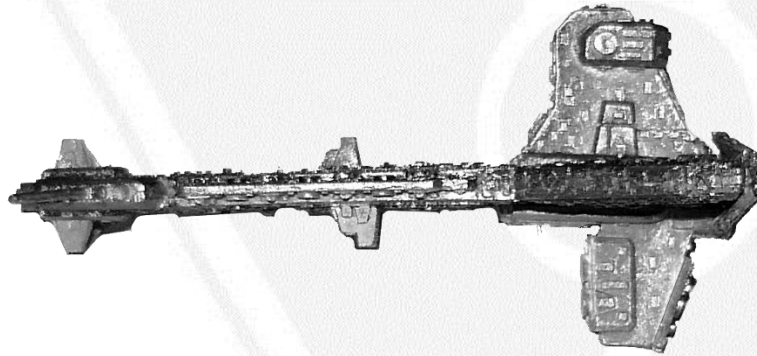

Hidden among the more closely-guarded systems frequented by the Demiurg are vessels specialized for mining and resource harvesting. These vessels outwardly resemble Bastion vessels in all respects but vary in critical details. The volume in Bastion vessels dedicated to attack craft and broadside lances is entirely turned over to specialized resource harvesting equipment. Outwardly they resemble the more familiar but still rare Bastion commerce vessels in all respects, and only through their interaction with the Tau did some Rogue Traders become aware there was a distinction between ship types.

| TYPE /HITS | SPEED | TURNS | SHIELDS | ARMOR | TURRETS |
|---------------------------|-------|-------------|--------------------|------------|------------|
| Cruiser/6 | 20cm | 45° | 2 | 5+/6+ Prow | 3 |
| ARMAMENT | | RANGE | FIREPOWER/STRENGTH | | FIRE ARC |
| Port Weapons Battery | | 30cm | 6 | | Left |
| Starboard Weapons Battery | | 30cm | 6 | | Right |
| Prow Weapons Battery | | 45cm | 8 | | Front |
| Prow Cutting Beam | | 15cm | Special (max 8) | | Front |
| Dorsal Torpedoes | | Speed: 30cm | 4 | | All Around |

Demiurg Cutting Beam

This weapon is a short ranged but devastating ionization beam. In addition to the rules described for this weapon on p.109 of Armada, any Demiurg vessel may extend the range of its cutting beam to 30cm by expending two collected blast markers per weapon strength instead of one, rounding down. For example, a Demiurg Bastion that gathers up four blast markers in the course of its immediately previous movement may in the shooting phase fire a str-5, range-15cm cutting beam or a str-2, range-30cm cutting beam.

Notes: Demiurg Citadel class ships are heavily automated and count their Ld value as 9 at the start of the battle. The Citadel's Ld will drop by -1 for each point of damage it suffers, but its Ld value will not drop any further than 5. Bridge smashed critical hits will not inflict additional Leadership loss on a Demiurg ship, but instead cause an extra point of damage (and possible attendant Ld loss) on the vessel.

A Citadel class vessel is worth 185 Victory points normally but in a pure Demiurg fleet or one fighting against Orks it is worth 200 Victory points instead to reflect its extra determination. This does not affect its starting point cost.

Demiurg 'Citadel' class vessels cannot employ Come to New Heading special orders.

Using Citadel Commerce Vessels

Citadel Commerce Vessels outwardly resemble Bastion Commerce vessels in all respects, and the same model may be used to represent either ship class. To represent its complex resource-gathering and harvesting systems, the model is mounted on a large base, which due to the unique nature of Demiurg shields is not nearly the handicap it would be for other races! It can be used as allies in the same manner as Bastion Commerce Vessels in any fleet that can take Bastions. This allows Demiurg vessels to be used in a pure fleet or be taken as a ship choice in scenarios limited by the amount of points that may be taken.

"You misunderstand, this is Tau space, despite what the Gue'la may claim, and you are welcomed to it as friend. We too have suffered difficulty with the Or'es'la, since it seems they wish no unity. We would be honoured to have you fight alongside us against this common enemy. You will find it to the benefit of both our peoples. You will find it, I have no doubt, to be for the Greater Good."

*-Por'O Dal'yth V'Rok
greeted the Thurm Brotherhood
during first contact with the Demiurg*

NICASSAR CARAVAN 200 Points

| TYPE /HITS | SPEED | TURNS | SHIELDS | ARMOR | TURRETS |
|-----------------|-------|---------|---------------------|-------|------------|
| Defense/8 | 10cm | Special | 4 | 5+ | 6 |
| ARMAMENT | | RANGE | FIREPOWER/STRENGTH | | FIRE ARC |
| Railgun Battery | | 30cm | 10 | | All Around |
| Gravitic Hook | | - | 4 Dhows (see notes) | | - |

Notes: Their point cost and profile above reflects a slightly modified Nicassar Rig and four Dhows, as described on pp.106-107 of Armada. Nicassar Caravans are ponderously slow, but like their individual Dhows, they are surprisingly maneuverable. A Nicassar Caravan moves 10cm in any direction during the movement phase, no more, no less. It is not slowed down by blast markers, celestial phenomena or being crippled, and it cannot take Burn Retros, Come To New Heading or All Ahead Full Special Orders. Nicassar Caravans have +1 Leadership (max. 10).

Using Nicassar Caravans

As opposed to a Rig and its separate Dhows described on pp.106-107 of Armada, a Nicassar Caravan in motion has its Rig and Dhows as a single entity that does not separate throughout the course of the battle and is treated as a single vessel in all respects. It can be crippled normally, but it does not take critical damage in the normal sense. If the Caravan takes critical damage, apply an additional 1Hp damage instead. When a Caravan is reduced to zero hits, it and its Dhows all count as destroyed. Remove it from play and replace it with four blast markers centered around the point where it was destroyed.

Though they have very little combat utility, Nicassar have powerful minds and rely on their telekinetic talents in particular to make up for their own limited mobility. Their extended families are semi-nomadic and are driven by insatiable curiosity. Their spacefaring skills are exemplary, and it is in this manner they best serve the Greater Good. Trading caravans are the large networks of conjoined Dhows which the Nicassar employ when travelling over long distances at their natural leisurely pace, sometimes over the course of centuries.

As they are most content when travelling and can survive for long periods in virtual hibernation, they are uniquely suited for their service to the Tau, exploring systems on the fringes of the Tau Empire. Occasionally caravans accompany Tau fleets to war, and if attacked the Dhows will attempt to move the community to safety, though it is not unknown for them to detach and fight vigorously in defense of their community and the Tau vessels supporting them.

NICASSAR RIG 40 Points

| TYPE /HITS | SPEED | TURNS | SHIELDS | ARMOR | TURRETS |
|---------------|-------|-------|--------------------|-------|----------|
| Defense/4 | 0cm | 0° | 1 | 5+ | 6 |
| ARMAMENT | | RANGE | FIREPOWER/STRENGTH | | FIRE ARC |
| Gravitic Hook | | - | 4 Dhows | | - |

Notes: For every Nicassar Rig in the fleet, four Dhows must be purchased as described on pp. 106-107 of Armada. Their gravitic hooks count toward the number of Dhows in the fleet and cannot be used on any other escort type.

Using Nicassar Rigs

A Nicassar Rig and its four Dhows remain separate throughout the course of a battle, and the rig itself is stationary in the same manner of any other planetary defense. However, it is not limited as to where it is placed on the table unlike other planetary defenses and does not need to be placed within 15cm of celestial phenomena. A Caravan and a Rig with its four Dhows are essentially identical, despite the different profiles listed above. In the course of a campaign, a player may substitute one for the other for every Rig or Caravan on the fleet list before the start of a battle simply by deciding whether or not the Rig is to move or remain stationary. Once the decision is made, it cannot be changed until the start of the following battle.

Upon encountering something of interest in wilderness space, a Nicassar Caravan will detach a number of its Dhows to investigate, though it is immobile while its Dhows are maneuvering separately in this manner. While Caravans will always attempt to retreat in the face of hostility, it is not unknown in desperate situations for a Rig's Dhows to remain separate and actively defend it against a particular threat.



KOR'OR'VESH VESSELS IN THE KOR'VATTRA FLEET LIST

Kor'or'vesh vessels can be deployed in a particularly important Commerce and Exploration fleet as a mixed flotilla of vessels integrated in the current Tau list in Armada, with a number of restrictions due to their great expense and rarity.

TAU KOR'OR'VESH: COMMERCE PROTECTION FLEET

This fleet list is identical to that on p. 112 of Armada, with the following changes and/or additions:

FLEET COMMANDER

Your fleet must include a commander if it is greater than 750 points. If it is greater than 750 points, the commander may be a Kor'el or a Kor'O. If the fleet includes a Custodian, a Kor'O must lead it.

Tau Kor'el (Ld 8) 50 points
 Tau Kor'O (Ld 9) 80 points

The commander has one re-roll included in his points cost. If you wish, the commander's ship may carry a member of the Ethereal caste and therefore purchase additional re-rolls at the cost shown.

Aun'el (one extra re-roll) +25 points
 Aun'O (two extra re-rolls) +75 points

CAPITAL SHIPS

Battleships

Your fleet may include any number of Explorer battleships. Your fleet may include up to one Custodian per FULL 750 points of Tau vessels. Allied vessels don't count toward this total. For example, a fleet that has at least 750 points of Tau vessels in it may include a single Custodian. Fleets of at least 1,500 points may include two Custodians.

Custodian class battleship 330 points
 Explorer class starship 230 points



Cruisers

Your fleet may include any number of Merchant, Emissary or Protector class starships. It may also include up to one Hero class starship for every other type of capital ship in the fleet.

Protector class starship 185 points
 Hero class starship 180 points
 Emissary class starship 110 points
 Merchant class starship 95 points

ESCORTS

Your fleet may include up to one Messenger class starship per 500 points.

Messenger class starship 50 points

Your fleet may include any number of Defender and/or Castellan class starships.

Castellan class starship 50 points
 Defender class starship 45 points

You may not have more Orcas and Wardens than the gravitic hook capacity of the fleet. Much of the cost of these vessels is included in that of the parent ship.

Warden class gunship 30 points
 Orca class gunship 25 points

ALLIES, SUBJECTS & MERCENARIES

The rules described on pp.107-112 of Armada remain unchanged except as described here.

Demiurg Vessels

There cannot be more Stronghold than Bastion vessels in the fleet.

Stronghold Commerce Vessel 350 points
 Bastion Commerce Vessel 255 points
 Citadel Commerce Vessel 185 points

Kroot Vessels – (0-2)

Warspheres do not count against cruiser limits in a Kor'vattra Fleet.

Kroot Warsphere 145 points

Using Kroot Warspheres

The Kroot approach spacefaring with an innate sense bereft of the technological advances so keenly sought by other races. When the Damocles Crusade revealed shortcomings in the Warsphere compared to Imperial starships, the Kroot adapted simply by constructing larger Warspheres.

In any fleet list, a Kroot Warsphere may subtract up to -4HP or add up to +6HP from its regular profile, for 20 points added or subtracted per 2HP. For every 2HP, it adds or subtracts +2 firepower to its weapons battery. Warspheres 10HP or greater may also add +1 shield and/or turret strength for +10 points each (no more than one each). A Kroot Warsphere 10HP or greater can extend the range of its weapons battery by +15cm for +25 points.

During planetary assaults, Kroot Warspheres cannot return to flight during a battle once they have landed. However, they are not destroyed and only count as disengaged for purposes of victory points.

Nicassar Vessels

No more Dhows may be taken than the grav hook capacity of the fleet. Grav hooks on a Custodian battleship or Emissary starship cannot count toward this total.

Nicassar Caravan 200 points
 Nicassar Rig 40 points (+ 4 Dhows)
 Nicassar Dhow 45 points

Rogue Traders

Up to one Rogue Trader cruiser and its attendant escorts may accompany the fleet for every 750 points of Tau ships in the fleet. Additionally, a single squadron of up to six Xenos escorts can be taken as per the Rogue Trader rules and fleet list.

Rogue Trader Cruiser 185 points
 Endeavor Light Cruiser 110 points
 Xenos vessel 50 points
 Recommissioned escort 30 points
 Iconoclast destroyer 30 points
 Rogue Trader cargo vessel 20 points

THE DEMIURG AND KROOT XENOS FLEET LIST

WAR HOST OF THE DEMIURG

The Demiurg will typically shy away from combat, though occasionally they will respond to threats with surprising ferocity. The Demiurg have plied the stellar void millennia before encountering the Tau, and on exceedingly rare occasion will muster their ships for war for reasons entirely unrelated to their relationship to the Tau.

AFFILIATION OF BROTHERHOODS

Demiurg fleets are composed of a loosely-defined but tightly knit affiliation of "Brotherhoods" that rely on an exceedingly high level of automation and are not organized in the manner of typical fleet organizations. Because of this, Demiurg fleets have no Fleet Commander in the conventional sense, which affects their fleet in the following ways:

Re-rolls

A Demiurg fleet may purchase re-rolls, but they are purchased by the fleet as a whole, rather than being considered Fleet Commander rerolls. The fleet gets one re-roll and can purchase extra re-rolls at the cost shown. These re-rolls can only be used for Demiurg vessels and not with other starships they may take as allies in their war host.

One extra re-roll 25 points
Two extra re-rolls 75 points

Determination

Demiurg vessels used against this fleet list do not attempt to disengage unless they have 2Hp or less remaining. Though their point cost remains unchanged, Strongholds are worth 400 points, Bastions are worth 300 points and Citadels are worth 200 points when determining Victory Points.

CAPITAL SHIPS

Battleships

Your fleet may include one battleship for every two cruiser-class vessels in the fleet.

Stronghold Commerce Vessel 350 points

Cruisers

Your fleet may include no more than twelve cruisers. Demiurg Commerce Vessels must outnumber all non-Demiurg cruisers combined.

Bastion Commerce Vessel 255 points
Citadel Commerce Vessel 185 points
Protector class cruiser 185 points
Rogue Trader Cruiser 185 points
Hero class starship 180 points
Endeavor light cruiser 110 points
Emissary class starship 110 points
Merchant class starship 95 points

Kroot Vessels – (0-3)

The Demiurg have a unique, little-understood relationship with the Kroot pre-dating that with the Tau, and it is not uncommon for their ships to be encountered together.

The fleet may have one Kroot Warsphere in the fleet for every 750 points in the fleet or portion thereof. These do not count against the number of cruisers in the fleet. (See note on p.15 concerning Warspheres).

Kroot Warsphere 145 points

ESCORTS

The Demiurg do not make use of escorts in the same manner of other fleets. However, they will contract or otherwise arrange the use of escort squadrons as the need arises.

For every three Demiurg capital ships in the fleet, it may include one squadron of up to six Tau or Rogue Trader escorts. Nicassar Dhows, Tau Wardens or Orcas can be taken for every starship in the fleet equipped with grav hooks. Tau, Nicassar and Rogue Trader escorts may not be mixed in the same squadrons.

Tau Escorts

Castellan class starship 50 points
Defender class starship 45 points
Nicassar Dhow 45 points
Warden class gunship 30 points
Orca class gunship 25 points

Rogue Trader Escorts

Xenos vessel 50 points
Recommissioned escort 30 points
Iconoclast destroyer 30 points
Rogue Trader cargo vessel 20 points

ORDNANCE & UPGRADES

Demiurg ships utilize highly automated versions of torpedoes, fighters, bombers and assault boats. They do not have access to boarding torpedoes but may use torpedo bombers for +10 points per launch bay.

Leadership and Attack Rating

The Demiurg fleet has an Attack or Initiative rating of 2. Vessels allied with the Demiurg rely on the basic leadership applicable to their fleets. They cannot use Demiurg fleet re-rolls, but if available they may purchase special characters with any re-rolls they come with to lead their ships.

Campaigns

In campaigns, Demiurg and vessels on this fleet list allied with them may gain leadership, crew skills and refits in the same manner as Imperial vessels (max Ld-10).

